

AUFBAUANLEITUNG

Gerätehaus „NEO“ 1A, 2A, 1B und 2B

- Ⓜ GB Assembly manual for garden shed “NEO” size 1A, 2A, 1B and 2B
- Ⓜ FR Notice de montage pour l’abri de jardin “NEO” taille 1A, 2A, 1B et 2B
- Ⓜ NL Opbouwbeschrijving berging “NEO” grootte 1A, 2A, 1B en 2B
- Ⓜ ES Instrucciones de montaje de la caseta modelo “NEO” tamaño 1A, 2A, 1B y 2B
- Ⓜ IT Istruzioni di montaggio Casetta portattrezzi “NEO” misura 1A, 2A, 1B e 2B
- Ⓜ DK Monteringsvejledning for redskabsskuret “NEO” størrelse 1A, 2A, 1B og 2B
- Ⓜ SE Monteringsanvisning för NEO redskapsbod storlek 1A, 2A, 1B och 2B
- Ⓜ NO Monteringsanvisning for boden “NEO” str 1A, 2A, 1B og 2B
- Ⓜ PL Instrukcja montażu domku ogrodowego „NEO” wielkości 1A, 2A, 1B i 2B
- Ⓜ SK Montážny návod pre záhradný domček „NEO” veľ. 1A, 2A, 1B a 2B
- Ⓜ SI Priročnik za montažo vrtno lope „NEO” velikosti 1A, 2A, 1B in 2B
- Ⓜ CZ Montážní návod pro zahradní domek „NEO” velikost 1A, 2A, 1B a 2B
- Ⓜ HU Felépítési útmutató „NEO” szerszámú házhoz méretekre 1A, 2A, 1B és 2B
- Ⓜ HR Priručnik za montažu vrtno kuće „NEO” veličine 1A, 2A, 1B i 2B



WICHTIGE PUNKTE FÜR DEN AUFBAU!



VORLIEGENDE AUFBAUANLEITUNG ZEIGT DEN ZUSAMMENBAU VON GERÄTEHAUS „NEO“ GRÖSSE „2B“; SIE GILT SINNGEMÄSS AUCH FÜR DIE GRÖSSEN „1A, 2A, 1B“. FÜR EINIGE MONTAGESCHRITTE BENÖTIGEN SIE 1 BIS 2 HELFER.

- GB** Important details regarding assembly! This assembly manual shows the erection of the garden shed model "NEO" size "2B"; it is also valid for size "1A, 2A, 1B". For several assembly steps additional assistance of 1 or 2 people will be required.
- FR** Points importants lors du montage! Cette notice de montage décrit l'assemblage de l'abri „NEO“ taille « 2B »; celle-ci est aussi valable pour la taille « 1A, 2A, 1B ». Pour certaines étapes, demandez l'aide d'une ou deux personnes.
- NL** Deze montage instructies hebben betrekking op de opbouw van de NEO , grootte 2B. De instructies zijn ook van toepassing op de grootte 1A, 2A, 1B. Voor enkele montage stappen heeft u 1 of 2 extra mensen nodig.
- ES** Notas importantes para el montaje: Estas instrucciones muestran el montaje de la caseta "NEO" en tamaño 2B. También son válidas para el tamaño 1A, 2A, 1B. Es recomendable realizar el montaje entre dos o tres personas.
- IT** Indicazioni importanti per il montaggio! Le seguenti istruzioni di montaggio fanno riferimento all'assemblaggio di „NEO“ misura „2B“; per analogia sono valide anche per la misura „1A, 2A, 1B“. Per alcune fasi di assemblaggio vi serviranno 1 - 2 aiutanti.
- DK** Vigtige punkter ved samling! Samlemanualen viser opsætningen af havekur modellen "NEO" str. "2B"; gælder også for størrelse "1A, 2A, 1B". Ved flere punkter af opsætningen er yderligere hjælp påkrævet af 1 eller 2 personer.
- SE** Dessa monteringsanvisningar visar hur "NEO" storlek 3C monteras. Anvisningarna gäller på motsvarande sätt för storlek "1A, 2A, 1B". För vissa monteringssteg behöver du 1 till 2 medhjälpare.
- NO** Denne monteringsanvisningen viser montering av boden "NEO" størrelse "3C"; den er også gyldig for størrelse "1A, 2A, 1B". For flere monteringsstrinn vil det være nødvendig med ytterligere assistanse fra 1 eller 2 personer.
- PL** Niniejsza instrukcja wskazuje sposób montażu domku "NEO" wielkości 3C. Pozostałe wielkości - "1A, 2A, 1B" - analogicznie. Może być konieczna pomoc drugiej osoby.
- SK** Táto montážna príručka popisuje stavbu záhradného domčeka "NEO" veľkosti „3C“; platí aj pre veľkosť "1A, 2A, 1B". Pri niekoľkých montážnych krokoch bude potrebné ďalšie pomoc 1 alebo 2 osôb.
- SI** Ta priročnik za montažo prikazuje postavitev vrtno lope model "NEO" velikosti "3C"; velja tudi za velikosti "1A, 2A, 1B". Za več korakov sestavljanja bo potrebna dodatna pomoč 1 ali 2 oseb.
- CZ** Tyto montážní pokyny ukazují sestavení "NEO" velikosti „3C“; platí také pro velikosti "1A, 2A, 1B". Pro některé kroky montáže potřebujete 1 nebo 2 pomocníky.
- HU** Ez a szerelési útmutató a "NEO" 3C méretű ház összeszerelését mutatja; ez értelemszerűen a "1A, 2A, 1B" méretekre is vonatkozik. Néhány összeszerelési lépéshez 1-2 fő segítségére lesz szüksége.
- HR** Ovaj priručnik za montažu prikazuje postavljanje vrtno kuće modela "NEO" veličine „3C“; vrijedi i za veličine "1A, 2A, 1B". Za nekoliko koraka montaže bit će potrebna dodatna pomoć 1 ili 2 osobe.

VERWENDEN SIE BEI DER MONTAGE ARBEITSHANDSCHUHE! UM KRATZER ZU VERMEIDEN, VERWENDEN SIE BITTE GEEIGNETE UNTERLAGEN!

- GB** Wear working gloves! Please use a suitable underlay to avoid scratches!
- FR** Portez des gants de travail! Pour éviter les rayures, utilisez les supports appropriés!
- NL** Handschoenen gebruiken! Om krassen te voorkomen raden wij u aan er iets onder te leggen!
- ES** Utilice unos guantes de trabajo. Por favor, coloque en el suelo una base protectora adecuada para evitar posibles arañazos.
- IT** Utilizzare guanti da lavoro. Utilizzare una base adatta per evitare graffi!
- DK** Brug arbejdshandsker! Benyt venligst et passende underlag for at undgå skrammer!
- SE** Använd arbetshandskar under monteringen! Använd lämpliga underlag för att undvika repor!
- NO** Bruk arbeidshansker! Bruk et passende underlag for å unngå riper!
- PL** Podczas montażu proszę używać rękawice ochronne. Chronić powierzchnię lakierowaną przed zarysowaniami.
- SK** Používajte pracovné rukavice! Prosím, použite vhodnú podložku, aby ste zabránili poškrábaniu!
- SI** Uporabite delovne rokavice! Uporabite ustrezno podlago, da se izognete praskam!
- CZ** Při montáži používejte pracovní rukavice! Použijte vhodné podložky, abyste se vyhnuli poškrábání!
- HU** Szerelésnél használjon védőkesztyűt! A karcolások elkerülése érdekében használjon megfelelő alátétetket!
- HR** Nosite radne rukavice! Upotrijebite odgovarajuće podlago, da se izognete praskam!



ACHTEN SIE AUF EINE STURMSICHERE BODENVERANKERUNG UND VERSPERREN SIE DIE TÜREN! NICHT BEI WIND AUFBAUEN!

- (GB)** Please make sure the product is anchored in a storm-proof manner and lock the doors! Do not assembly in windy condition!
- (FR)** Veillez à ce que le sol soit ancré de manière à résister aux tempêtes et verrouillez les portes! Ne pas procéder au montage dans des conditions venteuses !
- (NL)** Zorg voor een stormbestendige bodem verankering en vergrendel de deuren! Niet opbouwen in winderige omstandigheden!
- (ES)** Asegúrese de que el suelo cuente con un anclaje a prueba de tormentas y cierre las puertas. ¡No se instalen en condiciones de viento!
- (IT)** Assicuratevi che il pavimento sia ancorato a prova di tempesta e chiudete a chiave le porte! Non montare in condizioni di vento!
- (DK)** Vær opmærksom på at produktet forankres stormsikkert samt at dør er aflåst! Bør ikke monteres ved kraftig vind!
- (SE)** Se till att markförankringen är stormsäker och lås dörrar! Genomför inte monteringen när det blåser!
- (NO)** Forsikre deg om at produktet er ordentlig forankret på en storm sikker måte og lås dørene! Ikke monter når det blåser mye!
- (PL)** Zwróć uwagę na wiatroodporne zakotwiczenie w ziemi i zamykaj drzwi! Nie montować przy silnym wietrze!
- (SK)** Dbajte na podlahové ukotvenie proti víchrici a zaistite dvere! Nerobte montáž pri vetre!
- (SI)** Prepričajte se, da je izdelek zasidran zaradi neviht in zaklepajte vrata! Ne sestavljajte v vetrovnem stanju!
- (CZ)** Zkontrolujte podlahové ukotvení odolné proti bouři a zamkněte dveře! Nenechávejte ve větru otevřené a nezajištěné!
- (HU)** Figyeljen a padló viharbiztos rögzítésére, valamint az ajtók és a tető zárhatóságára! Ne szélben építse fel!
- (HR)** Molimo osigurajte da je proizvod usidren na oluju i zaključajte vrata! Ne montirajte u vjetrovitom stanju!



ACHTUNG: IM SOMMER KÖNNEN IM INNENRAUM SEHR HOHE TEMPERATUREN ENTSTEHEN!

- (GB)** Attention: during the summer high temperature might arise in the interior.
- (FR)** Attention: En été la température à l'intérieur de l'abri peut être élevée!
- (NL)** Let op: in de zomer kunnen in de berging zeer hoge temperaturen bereikt worden.
- (ES)** Tenga en cuenta que en el verano las temperaturas en el interior pueden ser altas.
- (IT)** I dadi devono essere serrati a fondo soltanto alla fine del montaggio!
- (DK)** Attention: Si prega di prendere nota che in estate si possono essere temperature molto elevate all'interno.
- (SE)** På sommaren kan mycket höga temperaturer uppstå inne i redskapsboden!
- (NO)** OBS: om sommeren kan det oppstå høy temperatur inne i produktet.
- (PL)** Uwaga: latem temperatura wewnątrz może wysoko wzrosnąć!
- (SK)** Pozor: v lete môže v interiéri dôjsť k zvýšeniu teploty.
- (SI)** Pozor: poleti se lahko v notranjosti pojavi visoka temperatura.
- (CZ)** Pozor: v létě může v interiéru dojít ke zvýšení teploty.
- (HU)** FIGYELEM: Nyáron a tárolók belsejében nagyon magas lehet a hőmérséklet!
- (HR)** Pažnja: tijekom ljeta u unutrašnjosti se može pojaviti visoka temperatura.

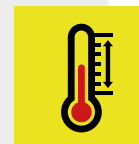

MASSTABSGETREUE ABBILDUNGEN DER ZU VERWENDENDEN SCHRAUBEN! (M 1:1)

- (GB)** Scale drawing 1:1 of the screws in use
- (FR)** Reproduction selon l'échelle 1:1.
- (NL)** Afbeelding : schaal 1:1 (ware grootte)
- (ES)** Reproducción a escala 1:1 de los tornillos que se utilizan para el montaje.
- (IT)** Immagine in scala delle viti da utilizzare!
- (DK)** Skala tegning af skruer er 1:1
- (SE)** Skalenliga ritningar av skruvarna som ska användas:
- (NO)** Måltegning 1: 1 av skruene som er i bruk
- (PL)** Skalowane ilustracje używanych śrub:
- (SK)** Mierka výkresu 1: 1 použitých skrutiiek
- (SI)** Risba v merilu 1: 1 uporabljenih vijakov
- (CZ)** Měřitko výkresu 1: 1 použitých šroubů
- (HU)** A felhasználandó csavarok méretarányos ábrái:
- (HR)** Crtež veličine 1: 1 vijaka koji se koriste

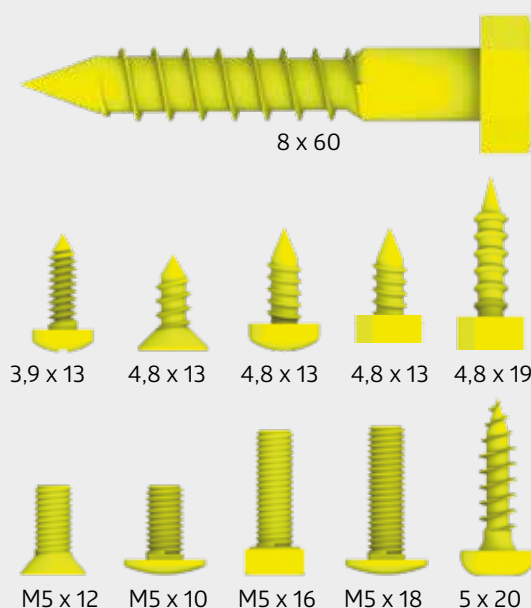

WASSERWAAGEN - SYMBOL!

Betreffendes Einbauteil mit der Wasserwaage ausrichten.

- (GB)** Symbol of spirit level: Align the respective parts by using the spirit level.
- (FR)** Symbole niveau à bulle: Lorsque ce symbole apparaît, vous devez ajuster l'élément à l'aide d'un niveau à bulle.
- (NL)** Waterpas – symbol: Bij montagestappen waar dit symbool bijstaat is het noodzakelijk het betreffende onderdeel waterpas in te bouwen.
- (ES)** Símbolo del nivelador: Indica que se debe ajustar y centrar la pieza con la ayuda de un nivelador.
- (IT)** Simbolo di livella a bolla d'aria: Allineare il componente in questione con l'ausilio di una livella a bolla d'aria.
- (DK)** Symbol for vaterpas: Juster de respektive dele ved hjælp af vaterpas.
- (SE)** Vattenpassymbol: Rikta in relevant installationsdel med vattenpasset.
- (NO)** Symbol på vater: Juster de respektive delene ved å bruke et vater.
- (PL)** Symbol poziomiczy - element wypoziomować.
- (SK)** Symbol vodováhy: Vyrovnajte príslušnej časti pomocou vodováhy.
- (SI)** Simbol vodne tehtnice: Poravnajte ustrezne dele z uporabo vodne tehtnice.
- (CZ)** Symbol vodováhy: Vyrovnajte příslušné části pomocí vodováhy.
- (HU)** Vízmérték – szimbólum: A szükséges elem beállításához használjon vízmértéket.
- (HR)** Simbol libele: Poravnajte odgovarajuće dijelove pomoću libele.

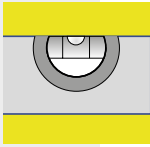

SCHRAUBVERBINDUNGEN GRUNDSÄTZLICH ERST AM ENDE DER MONTAGE FESTZIEHEN!

- (GB)** Nuts not to be tightened before the end of assembly!
- (FR)** Ne serrer les écrous à fond qu'à la fin du montage!
- (NL)** Schroeven pas aan het einde van de montage vastdraaien!
- (ES)** En principio, no apriete fijamente las tuercas hasta que no haya terminado de montar la caseta.
- (IT)** I dadi devono essere serrati a fondo soltanto alla fine del montaggio!
- (DK)** Møtrikkerne må ikke strammes før slutningen af opsætningen!
- (SE)** Dra alltid åt skruvförbanden först i slutet av monteringen!
- (NO)** Muttere som ikke skal strammes til før monteringen er ferdig!
- (PL)** Śruby dokręcić ostatecznie dopiero po zakończeniu montażu.
- (SK)** Matica dotahujte až pred koncom montáže!
- (SI)** Matic ne privijte pred koncem montáže!
- (CZ)** Matice dotahujte až před koncem montáže!
- (HU)** A csavarokat mindig csak az összeszerelés végén kell erősen meghúzni!
- (HR)** Matice ne treba stezati prije kraja montáže!

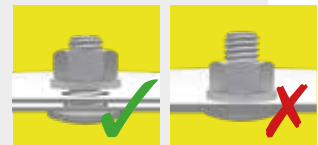

OPTIONALES ZUBEHÖR - SYMBOL!

Arbeitsschritte, die blau eingerahmt sind, zeigen den Einbau eines optionalen Zubehörteiles.

- (GB)** Symbol of optional accessories: Blue framed assembly steps show the installation of optional accessories.
- (FR)** Accessoires en option-Symbole: La trame entourée en bleu indique une étape avec accessoires en option. A réaliser uniquement si vous avez commandé cet accessoire.
- (NL)** Extra Toebehoor: Montagestappen met een blauwe rand betreffen de inbouw van extra toebehoor.
- (ES)** Accesorio opcional – símbolo: Los pasos de montaje que se encuentran enmarcados en azul muestran el montaje de una pieza de un accesorio opcional.
- (IT)** Simbolo per accessori opzionali: Le fasi del montaggio incorniciate in colore azzurro mostrano l'installazione di un accessorio opzionale.
- (DK)** Symbol for ekstra udstyr: Blåt indrammet samletrin viser installationen af ekstraudstyr.
- (SE)** Symbol för extra tillbehör: Arbetssteg som är inramade i blått visar hur ett valfritt tillbehör installeras.
- (NO)** Symbol for tilleggsgutstyr: Blå innrammede monteringsstrinn viser installasjonen av ekstrautstyr.
- (PL)** Wyposażenie dodatkowe - symbol: Czynności w niebieskiej ramce dotyczą elementów wyposażenia dodatkowego.
- (SK)** Symbol voliteľného príslušenstva: Montážne kroky v modrom rámečku ukazujú inštaláciu voliteľného príslušenstva.
- (SI)** Simbol dodatne opreme: Montažni koraki v modrem okvirju prikazujejo namestitve dodatne opreme.
- (CZ)** Symbol volitelného příslušenství: Montážní kroky v modrém rámečku ukazují instalaci volitelného příslušenství.
- (HU)** Opcionális tartozék – szimbólum: A kékkel bekeretezett munkafolyamatok az opcionális tartozék beépítését jelölik.
- (HR)** Simbol dodatne opreme: Montažni koraci u plavom okviru ukazuju na ugradnju dodatne opreme.



QR-CODE: EINZELNE SCHRITTE ÜBER VIDEO ABRUFBAR!

Bei bestimmten Montageschritten können Sie über den angegebenen QR-Code ein YouTube Video starten, welches Ihnen den dazugehörigen Montageschritt zeigt.

- GB** QR CODE: INDIVIDUAL STEPS CAN BE VIEWED VIA VIDEO. For certain assembly steps, you can start a YouTube video via the designated QR code, which shows you the corresponding assembly step.
- FR** QR-CODE : LES DIFFÉRENTES ÉTAPES PEUVENT ÊTRE VISUALISÉES PAR VIDÉO. Pour certaines étapes de montage, vous pouvez lancer une vidéo YouTube via le code QR spécifié, avec l'étape de montage correspondante.
- NL** QR-code: afzonderlijke stappen per video bekijken: Via de opgegeven QR-code kunt u voor bepaalde montageschappen een YouTube-video starten die u de bijbehorende montagestap laat zien.
- ES** CÓDIGO QR: LOS PASOS INDIVIDUALES PUEDEN SER CONSULTADOS A TRAVÉS DE VIDEO. Para ciertos pasos de montaje, puedes iniciar un video en YouTube mediante el código QR especificado, el cual muestra el paso de montaje correspondiente.
- IT** QR CODE: I SINGOLI PASSAGGI POSSONO ESSERE RICHIAMATI VIA VIDEO. Per determinate fasi di montaggio, è possibile avviare un video youtube tramite il codice qr specificato, che mostra la corrispondente fase di montaggio.
- DK** QR Kode: De enkelte skridt kan ses på video. For specifikke montage steps kan du se en YouTube video via den medfølgende QR kode, som viser de matchende montagevejledninger.
- SE** QR-KOD: ENSKILDA STEG FINNS PÅ VIDEO. För vissa monteringssteg kan du starta en YouTube-video som visar tillhörande monteringssteg med den angivna QR-koden.
- NO** QR-KODE: INDIVIDUELLE TRINN KAN SEES VIA VIDEO. For visse monteringsstrinn kan du starte en YouTube-video via den angitte QR-koden, som viser deg det tilsvarende monteringsstrinnet.
- PL** KOD QR: DOSTĘPNE INDYWIDUALNE INSTRUKCJE WIDEO: W przypadku niektórych etapów montażu możesz uruchomić wideo YouTube za pomocą określonego kodu QR, który pokazuje konkretny etap montażu.
- SK** QR CODE: K JEDNOTLIVÝM MONTÁŽNYM KROKOM LZE ZOBRAZIŤ VIDEO. U niektorých montážnych krokoch si na Youtube môžete pomocou daného QR kódu spustiť video návod, ktorý vám konkrétny krok ukáže.
- SI** QR KODA: POSAMEZNI KORAKI SO LAHKO OGLEDANI NA VIDEJU. Za določene korake sestavljanja lahko začnete videoposnetek v YouTubu, ki prek določene QR kode prikazuje ustrezen korak sestavljanja.
- CZ** QR CODE: K JEDNOTLIVÝM MONTÁŽNÍM KROKŮM LZE ZOBRAZIT VIDEO. U některých montážních kroků si na Youtube můžete pomocí daného QR kódu spustit video návod, který vám konkrétní krok ukáže.
- HU** QR kód: EGYES LÉPÉSEKHEZ VIDÉO TÖLTHETŐ LE. Bizonyos felépítési lépéseknél a megadott QR kóddal egy Youtube video tölthető le az aktuális szerelési lépéssel.
- HR** QR KOD: POJEDINAČNI KORACI SE MOGU POGLEDATI KROZ VIDEO. Za određene korake montaže možete pokrenuti YouTube video putem naznačenog QR koda, koji vam pokazuje odgovarajući korak montaže.



HALTEN SIE WÄHREND DES ZUSAMMENBAUS ALLE MITGELIEFERTEN KLEINTEILE ODER VERPACKUNGSMATERIALIEN FERN VON KLEINKINDERN!

Bauteile weisen scharfe Kanten auf oder stehen vor, achten Sie während der Montage und bei der täglichen Nutzung darauf.

- GB** Keep all supplied small parts or packaging materials away from small children during assembly. Components have sharp edges or protrude, pay attention to them during assembly and during daily use.
- FR** Gardez toutes les petites pièces ou les matériaux d'emballage fournis hors de portée des enfants pendant le montage. Les pièces d'assemblage peuvent être tranchantes, faites-y attention lors de l'assemblage et de l'utilisation quotidienne.
- NL** Houd alle kleine onderdelen of verpakkingsmaterialen die worden mee geleverd uit de buurt van kleine kinderen tijdens de montage. Onderdelen hebben scherpe randen of steken uit, let op bij de montage en bij het dagelijks gebruik.
- ES** Mantenga todas las piezas pequeñas o materiales de embalaje suministrados lejos de los niños durante el montaje. Los componentes tienen bordes afilados o salientes, preste atención a ellos durante el montaje y durante el uso diario.
- IT** Tenere tutte le piccole parti o i materiali d'imballaggio forniti lontano dalla portata dei bambini durante il montaggio. I componenti hanno spigoli vivi o sporgenti, prestare attenzione ad essi durante il montaggio e durante l'uso quotidiano.
- DK** Hold alle leverede smådele og emballage utilgængeligt for børn under montagen. Komponenter har skarpe kanter eller stikker ud, vær opmærksom på dem under montering og under daglig brug.
- SE** Håll alla medföljande smådelar och förpackningsmaterial borta från småbarn under monteringen. Komponenterna kan ha vassa kanter eller utstickande delar, var uppmärksam på detta vid montering och daglig användning.
- NO** OBS: Hold alle smådeler og emballasjemateriale borte fra små barn under montering. Komponentene har skarpe kanter eller noe som stikker ut, vær oppmerksom på dette under monteringen og under den daglige bruken.
- PL** ZACHOWAJ WSZYSTKIE MAŁE CZĘŚCI PODCZAS MONTAŻU LUB MATERIAŁY OPAKOWANIA Z DALA OD MAŁYCH DZIECI. Elementy mają ostre lub wystające krawędzie, należy zwracać na to uwagę podczas montażu i codziennego użytkowania.
- SK** Udržujte počas montáže všetky dodané malé diely a obalové materiály mimo dosahu malých detí. Komponenty majú ostré hrany alebo vyčnievajúce časti. Dbajte na to počas montáže a každodenného používania.
- SI** POZOR: Med montažo naj bodo vsi dobavljeni majhni deli ali embalažni materiali oddaljeni od majhnih otrok. Sestavni deli imajo ostre robove ali pa štrlijo, bodite pozorni nanje med sestavljanjem in med vsakodnevno uporabo.
- CZ** Během montáže udržujte všechny malé dodávané díly nebo obalové materiály mimo dosah malých dětí. Díly mají ostré hrany nebo vyčnívají, věnujte jim pozornost při montáži a každodenním používání, aby nedošlo k úrazu.
- HU** Az összeszerelés során kigyerekektől tartsa távol az apró alkatrészeket valamint a csomagolóanyagokat. A szerelés és a napi használat során ügyeljen az éles szélekre valamint a kiálló részekre.
- HR** PAŽNJA: Tijekom montaže držite sve isporučene male dijelove ili materijale za pakiranje podalje od male djece. Sastavni dijelovi imaju oštre rubove ili štrše, obratite pažnju na njih tijekom montaže i tijekom svakodnevnog uporabe.

UMGANG MIT BESCHÄDIGTEN TEILEN!

Verbauen Sie keine beschädigten Teile! Falls Sie Beschädigungen feststellen, müssen diese vorab inkl. aussagekräftiger Bilder an uns gemeldet werden. Durch den Verbau gelten die Teile als akzeptiert.

- (GB)** Handling of damaged parts: Do not install damaged parts! If you note damages, they must be reported to us in advance, including meaningful pictures. The parts are considered accepted by the installation.
- (FR)** Manipulation des pièces endommagées: N'installez pas de pièces endommagées! Si vous découvrez des dommages, vous devez nous en informer à l'avance, en nous envoyant des photos significatives. Après le montage, les pièces sont considérées comme acceptées.
- (NL)** Omgaan met beschadigde onderdelen: Monteer géén beschadigde onderdelen! Als u schade ontdekt, moet dit vooraf aan ons worden gemeld, inclusief duidelijke foto's. Als u de beschadigde onderdelen toch monteert, dan heeft u hiermee het product "geaccepteerd".
- (ES)** Manejo de partes dañadas: Por favor, NO instale partes dañadas, Si descubre algún daño, debe informarnos con antelación, incluyendo fotos claras de los daños. Las piezas se consideran aceptadas si se realiza su la instalación.
- (IT)** Gestione di parti danneggiate: Non installare parti danneggiate! Se si rivela un danno, questo deve essere segnalato in anticipo per mail con materiale fotografico a supporto del reclamo. Se si procede all'installazione delle parti danneggiate, Biohort si riserva il diritto di respingere il reclamo.
- (DK)** Håndtering af beskadigede dele: Brug ikke beskadigede dele! Hvis du opdager nogen skade, skal dette rapporteres til os på forhånd, herunder meningsfulde billeder. Dele betragtes som accepteret gennem installationen.
- (SE)** Hantering av skadade delar: Använd inte skadade delar! Om du upptäcker några skador måste detta rapporteras till oss i förväg, inklusive meningsfulla bilder. Delarna anses accepterade när de installeras.
- (NO)** Håndtering av ødelagte deler: Ikke monter ødelagte deler! Hvis du registrerer skader, må du rapportere dette til oss, og sende bilder av de skadde delene. Hvis skadde deler blir montert, anses de som akseptert av montøren.
- (PL)** POSTĘPOWANIE Z USZKODZONYMI CZĘŚCIAMI Nie używaj uszkodzonych części! W przypadku stwierdzenia jakichkolwiek uszkodzeń należy je zgłosić wraz ze szczegółowymi zdjęciami. Elementy uszkodzone zainstalowane uważane są za zaakceptowane.
- (SK)** Zaoščadzanie s poškodenými dielmi: V prípade že zistíte nejaké poškodenia, musia nám byť tieto nahlásené aj s príslušnými fotografiami. V prípade zabudovania budú diely považované za akceptované.
- (SI)** Ravnanje s poškodovanimi deli: Poškodovanih delov ne nameščajte! Če opazite škodo, nam je to treba sporočiti vnaprej, vključno s slikami. Namestitev šteje, kot da so deli sprejeti.
- (CZ)** Manipulace s poškozenými částmi: Pokud zjistíte poškození, musíte nám to nahlásit předem, včetně průkazných obrázků. Díly jsou považovány za přijaté jejich instalací.
- (HU)** A sérült alkatrészek kezelése: Ha bármilyen sérülést észlel, a sérült elemeket képekel igazolva jeleni kell felénk. A beépítéssel, az elemeket elfogadottnak tekintjük.
- (HR)** Rukovanje oštećenim dijelovima: Nemojte postavljati oštećene dijelove! Ako primijetite štetu, morate nam je prijaviti unaprijed, uključujući značajne slike. Instalacija smatra da su dijelovi prihvaćeni.

ZUM SORTIEREN DER MITGELIEFERTEN SCHRAUBEN UND KLEINTEILE FINDEN SIE IM KARTON EIN FALTBARES ORDNUNGSSYSTEM.

- (GB)** For sorting the supplied screws and small parts, you will find a foldable organiser system in the box.
- (FR)** Pour trier les vis et les petites pièces fournies, vous trouverez dans le colis un système d'organisation pliable.
- (NL)** Om de meegeleverde schroeven en kleine onderdelen te sorteren, vindt u in de doos een opvouwbaar opbergsysteem.
- (ES)** Para clasificar los tornillos y las piezas pequeñas suministradas, encontrará en la caja un sistema organizador plegable.
- (IT)** Per sistemare le viti e le piccole parti in dotazione, troverete un contenitore pieghevole nella scatola.
- (DK)** For at sortere de medfølgende skruer og små dele, finder du et foldbart organisationssystem i kassen.
- (SE)** För att sortera de medföljande skruvarna och små delarna hittar du ett fällbart organisationssystem i lådan.
- (NO)** For å sortere de skruene og små delene som følger med, finner du et sammenleggbart organisasjonssystem i esken.
- (PL)** W pudełku znajduje się składany system organizacyjny do sortowania dostarczonych śrub i małych części.
- (SK)** Pre roztriedenie dodaných skrutiek a malých dielov nájdete v krabici skladací organizačný systém.
- (SI)** Za sortiranje priloženih vijakov in majhnih delov boste v škatli našli zložljiv sistem organizatorjev.
- (CZ)** Pro rozřídění dodaných šroubů a malých dílů najdete v krabici skládací organizační systém.
- (HU)** A küldött csavarok és kis alkatrészek szortírozására, a dobozban egy kihajtogatható rendszerező kartont talál.
- (HR)** Za sortiranje isporučenih vijaka i malih dijelova u kutiji ćete pronaći sklopivi sustav organizatora



PFLEGE UND WARTUNG!

Keine aggressiven Chemikalien wie z.B. Chlor oder Streusalz lagern!

Sonnenmilch und andere Cremes mit Wasser und Seife entfernen!

Laub vom Dach regelmäßig entfernen! Dachgully kontrollieren!

Schraubverbindungen regelmäßig kontrollieren!

Keine scheuernden Reinigungsmittel verwenden!

Tiefe Kratzer sofort mit beiliegendem Lack ausbessern!

Ölen Sie das Schloss jährlich!

- (GB)** Care and maintenance: Do not store aggressive substances i.e. chlorine or road salt! Remove suntan lotion or any other creams with soap and water! Do not use abrasive cleaning agents! Keep the roof free of leaves! Check roof gully! ! Touch-up scratches immediately with the paint provided. Lubricate the lock once a year! Check screw connections regularly!
- (FR)** Entretien et maintenance: Ne pas stocker de produits chimiques (chlore, sel, etc...)! Nettoyez uniquement avec de l'eau les crèmes solaires et autres crèmes (pas de nettoyant chimique). Ne pas utiliser de produits nettoyant abrasifs! Débarrassez vous régulièrement des feuilles mortes sur le toit! Vérifiez la gouttière du toit ! Corrigez immédiatement les rayures avec la laque jointe! Graissez la serrure et les charnières chaque année! Vérifiez régulièrement les raccords à vis!
- (NL)** Onderhoud: Geen chemicaliën in de berging opslaan! Zonnebrandolie/melk en andere cremes met water en glansmiddel verwijderen. Gebruik geen schuurmiddelen! Regelmatig bladeren van dak verwijderen! Controleer de dakgoot! · Krassen direct met de meegeleverde lak behandelen. Slot jaarlijks oliën. Controleer regelmatig de Schroefverbindingen!
- (ES)** Cuidado y mantenimiento: No almacene productos químicos agresivos dentro de la caseta como por ejemplo cloro y sal antiescarcha. Evite dejar huellas o restos de cremas solares sobre la chapa. Limpie la caseta siempre con agua y jabón. No utilice ningún producto para fregar. En general, evite siempre cualquier producto químico para limpiar la caseta. Mantenga el tejado libre de hojas secas. Compruebe el desagüe del tejado. Repare los arañazos lo antes posible con el barniz que se incluye. Aplique aceite en la cerradura y las bisagras una vez al año. ¡Compruebe las conexiones de los tornillos regularmente!
- (IT)** Manutenzione: Non lasciare prodotti chimici aggressivi (come ad esempio cloro o sale per strade) all'interno della casetta! Rimuovere crema solare e altre creme con acqua e brillantante! Non utilizzare detergenti contenenti sostanze aggressive! Mantenere il tetto libero da foglie! Controllare la grondaia! Ritoccare immediatamente eventuali graffi con la vernice fornita nella confezione! Lubrificare la serratura e le cerniere a cadenza annuale! Controllare regolarmente i collegamenti a vite!
- (DK)** Pleje og vedligeholdelse: Opbevar ikke aggressive stoffer dvs. Klor eller vejsalt! Fjern solcreme eller andre typer af creme med vand og rensningsmiddel! Brug ikke aggressive rengøringsmidler! Hold taget fri for blade! Kontrollér tagafløb! ! Ved skrammer, brug straks malingen som er stillet til rådighed! Smør låsen årligt! Kontrollér skruesamlinger jævnligt!
- (SE)** Skötsel och underhåll: Förvara inga aggressiva kemikalier som klor eller vägsalt öppet! Ta bort solkräm och andra krämer med tvål och vatten. Använd inte slipande rengöringsmedel! Ta bort löv från taket regelbundet! Kontrollera takavloppet! Kontrollera avloppsrännan! Reparera omedelbart djupa repor med medföljande färg! Olja låset årligen! Kontrollera skruvanslutningarna regelbundet!
- (NO)** Stell og vedlikehold: ikke oppbevar aggressive stoffer, dvs. klor eller veisalt! Fjern solkrem eller andre kremer med vann og skyllemiddel! Ikke bruk slipende rengjøringsmidler! Hold taket fritt for blader! Sjekk takrenna! Lakk over riper umiddelbart med medfølgende lakkstift. Smør låsen en gang i året! Kontrollér skruerforbindelsene regelmessig!
- (PL)** Pielęgnacja i konserwacja: Nie przechowywać chemikaliów jak związki chloru lub sól drogowa. Ewentualne zabrudzenia usuwać mydłem i wodą. Nie używaj ściernych środków czyszczących! Regularnie usuwaj liście z dachu! Sprawdź wylot rynny! Natychmiast napraw głębokie zadrapania za pomocą dołączonej farby! Co roku smaruj zamek!
- (SK)** Starostlivosť a údržba: Neskladujte agresívne látky, napr. chlór alebo posypovú soľ! Opaľovací krém alebo iné krémy odstráňte vodou a leštidlom! Nepoužívajte abrazívne čistiace prostriedky! Udržujte strechu bez listia! Skontrolujte odkvapové žľaby! Škrabance okamžite opravte priloženým opravným lakom. Raz ročne premažte zámky! Pravidelne kontrolujte skrutkové spoje!
- (SI)** Nega in vzdrževanje: Ne shranjujte agresivnih snovi, npr. Klora ali cestne soli! Losjon za sončenje ali druge kreme odstranite z vodo in sredstvom za izpiranje! Ne uporabljajte abrazivnih čistil! Na strehi naj ne bo listja! Preverite žleb! Prask se takoj dotaknite s priloženo barvo. Ključavnico namažite enkrat letno! Redno preverjajte vijčane povezave!
- (CZ)** Péče a údržba: Neskladujte agresivní látky, např. chlor nebo posypovou sůl! Opaľovací krém nebo jiné krémy odstráňte vodou a leštídem! Nepoužívejte abrazivní čisticí prostředky! Udržujte střechu bez listí! Zkontrolujte okapové žľaby! Škrabance okamžitě opravte priloženým opravným lakem. Jednou ročně promažte zámky! Pravidelně kontrolujte šroubové spoje!
- (HU)** Ápolás és karbantartás: Ne tároljon semmiféle agresszív vegyszert, mint pl.: klórt vagy sót bontatlan állapotban! Távolítsa el a naptejet és az egyéb krémeket víz és szappan használatával. Ne használjon súrolószereket! Rendszeresen távolítsa el a leveleket a tetőről! Ellenőrizze a tetőn lévő esővízelvezetőt! A mellékelt lakkal javítsa ki rögtön a mély karcolásokat! Évente olajozza be a zárat! Rendszeresen ellenőrizze a csavarokat!
- (HR)** Njega i održavanje: Ne skladištite agresivne tvari, tj. Klor ili cestovnu soľ! Losion za sunčanje ili bilo koje druge kreme uklonite vodom i sredstvom za ispiranje! Ne koristite abrazivna sredstva za čišćenje! Krov ne ostavljajte bez lišća! Provjerite oluk! Odmah dodirnite ogrebotine s priloženom bojom. Podmažite bravu jednom godišnje! Redovito provjeravajte vijčane spojeve!

FUNDAMENTDETAILS!

Weitere Details betreffend Fundament finden Sie auch unter www.biohort.com/Fundament

- (GB)** Further details about foundations you will find at www.biohort.com/foundation
- (FR)** Pour des détails supplémentaires, veuillez consulter www.biohort.com/foundations
- (NL)** Verdere details over het fundament vindt u ook op www.biohort.com/fundament
- (ES)** Encuentre información detallada sobre los cimientos en: www.biohort.com > servicios > cimientos
- (IT)** Per ulteriori dettagli si prega di consultare www.biohort.com/it/servizi/suggerimenti-per-le-fondamenta
- (DK)** Yderligere informationer om fundamentet finder du på www.biohort.com/foundation
- (SE)** Mer information om fundamentet hittar du även på www.biohort.com/se/service/fundamenttips
- (NO)** Ytterligere informasjon om fundament finner du på www.biohort.com/foundation
- (PL)** Więcej informacji n.t. montażu fundamentów na stronie: www.biohort.com/Fundament
- (SK)** Ďalšie informácie o základoch nájdete na www.biohort.com/foundation
- (SI)** Nadaljnje podrobnosti o temeljih najdete na www.biohort.com/foundation
- (CZ)** Další informace o základech najdete na www.biohort.com/foundation
- (HU)** Az alapzathoz szükséges további részletek a www.biohort.com/hu/szerviz/alapzat-otletek oldalon találhatóak.
- (HR)** Dodatne detalje o zakladama naći ćete na www.biohort.com/foundation

PFLEGE GLASELEMENTE! Glaselemente mit weichem Schwamm und mildem Reiniger säubern und mit klarem Wasser abspülen. Anschließend mit einem weichen, fusselfreien Tuch trocknen. Weitere Hinweise finden Sie unter www.biohort.com

- GB** Care of Glass Elements! Clean glass elements with a soft sponge and mild cleaner and rinse with clear water. Then dry with a soft, lint-free cloth. You will find further information at www.biohort.com.
- FR** Entretien des éléments en verre! Nettoyez les éléments en verre avec une éponge douce et un nettoyeur doux, puis rincez à l'eau claire. Séchez ensuite avec un chiffon doux et non pelucheux. Vous trouverez de plus amples informations sur le site www.biohort.com.
- NL** Verzorging van glaselementen! Reinig glazen elementen met een zachte spons en een mild schoonmaakmiddel en spoel af met helder water. Vervolgens afdrogen met een zachte, pluïsvrije doek. Meer informatie is te vinden op www.biohort.com
- ES** Cuidado de los elementos de vidrio! Limpie los elementos de vidrio con una esponja y un detergente suaves y enjuague con agua limpia. A continuación, secar con un paño suave y sin pelusas. Puede encontrar más información en www.biohort.com
- IT** Cura degli elementi in vetro! Pulire gli elementi in vetro con una spugna morbida e un detergente delicato e risciacquare con acqua pulita. Poi asciugare con un panno morbido e senza pelucchi. Potete trovare ulteriori informazioni su www.biohort.com
- DK** Vedligehold af glaselementer! Glaselementerne rengøres med en blød svamp og mildt rengøringsmiddel. Skyl efterfølgende med rent vand. Elementerne tørres med en blød fnugfri klud. Yderligere information kan findes på www.biohort.com
- SE** Skötsel av glaselement! Rengör glaselementen med en mjuk svamp och mildt rengöringsmedel och skölj med rent vatten. Torka sedan med en mjuk, luddfri trasa. Mer information finns på www.biohort.com
- NO** Vedlikehold av glaselementer! Rengjør glaselementene med en myk svamp, et mildt rengjøringsmiddel og skyll med rent vann. Tørk deretter med en myk, lofri klut. Ytterligere informasjon finnes på www.biohort.com
- PL** Pielęgnacja elementów szklanych! Oczyszczyć elementy szklane miękką gąbką i łagodnym środkiem czyszczącym i spłukać czystą wodą. Następnie osuszyć miękką, nieporowatą i niestrzępiącą się ściereczką.
- SK** Starostlivosť o sklenené prvky! Sklenené prvky čistite mäkkou špongiou s jemným čističím prostriedkom a opláchnite čistou vodou. Potom ich osušte mäkkou handričkou, ktorá nepúšťa vlákna. Ďalšie informácie nájdete na adrese www.biohort.com
- SI** Steklenega elementa! Steklene elemente očistite z mehko gobico in blagim čistilom ter sperite s čisto vodo. Nato posušite z mehko krpo, ki ne pušča vlaken. Dodatne informacije najdete na www.biohort.com.
- CZ** Péče o skleněné prvky! Skleněné prvky čistěte měkkou houbou s jemným čisticím prostředkem a opláchněte čistou vodou. Poté je osušte měkkým hadříkem, který nepouští vlákna. Další informace najdete na adrese www.biohort.com
- HU** Üvegelemek ápolása! Tisztítsa meg az üvegelemeket puha szivaccsal és enyhe tisztítószerrel, majd öblítse le tiszta vízzel. Ezután törölje szárazra egy puha, szőszmentes ronggyal. További információkat a www.biohort.com weboldalon találhat.
- HR** Održavanje staklenih površina! Mekanom spužvom i blagim sredstvom za čišćenje očistite i isperite čistom vodom. Nakon toga osušite sa mekanom krpom bez dlačica. Više informacija naći ćete na www.biohort.com



VORSCHLÄGE FÜR DAS FUNDAMENT!

Bitte achten Sie bei der Fundamentgestaltung darauf, dass Niederschlagswasser nicht seitlich unter den Bodenprofilen in das Gerätehaus eindringen kann! Aufsteigende Bodenfeuchtigkeit und Kondensation vermeiden Sie mittels einer starken Kunststoffolie unter dem Fundament.

- GB** Proposals for a secure foundation: When making the foundation arrangements please take necessary precaution to ensure that water cannot leak in under the floor profiles. Rising ground moisture and condensation can be avoided by using a strong plastic sheet underneath the paving slabs or underneath the concrete foundation.
- FR** Conseils pour les fondations: Lors de la réalisation de la fondation, veillez à ce que l'eau de pluie ne puisse pas pénétrer dans l'abri ou par les côtés sous les profils de sol. Vous pouvez éviter l'humidité du sol et la condensation en mettant un film plastique épais sous les plaques de béton.
- NL** Voorstellen voor fundament : Let er bij het maken van de fundering op dat regenwater niet onder het bodemprofiel kan doorlopen. Een vochtige bodem en condensatie kunt u vermijden door het aanbrengen van een sterke kunststoffolie onder de tegels of het betonfundament.
- ES** Medidas y recomendaciones para los cimientos: Al colocar los cimientos, asegúrese de que el agua de lluvia no puede penetrar en la caseta por los laterales debajo del perfil del suelo. Evite la humedad y la condensación en el suelo colocando una lámina de plástico bajo las losas o los cimientos de hormigón.
- IT** Proposte per il basamento: Il basamento deve essere progettato in modo da evitare infiltrazioni di acqua piovana all'interno della casetta. Un telo di plastica spesso posto in corrispondenza dell'area di pavimento evita infiltrazioni di umidità dal terreno e la formazione di condensa.
- DK** Forslag til sikkert fundament: Ved etablering af fundament skal du tage de nødvendige forholdsregler for at sikre, at vand ikke kan sive ind under gulvprofilerne. Stigende fugt og kondens i jorden kan undgås ved at bruge plastik under flisebelægningen eller under betonfundamentet:
- SE** Förslag för fundamentet: Se till att regnvatten inte kan tränga in i redskapsboden från sidan under golvprofilerna när du utformar fundamentet! Du kan undvika stigande markfuktighet och kondens genom att placera en kraftig plastfilm under fundamentet.
- NO** Forslag til et sikkert fundament: Når du lager fundamentet, må du ta de nødvendige forholdsregler for å sikre at vann ikke kan lekke inn under gulvprofilene. Økende fuktighet og kondens på bakken kan unngås ved å bruke en sterk plastduk under belegningsplatene eller under betongfundamentet.
- PL** Uwagi dot. Fundamentu: Przy projektowaniu fundamentu należy zwrócić uwagę, aby woda opadająca nie przedostawała się do wnętrza pod profilami podłogowymi! Stosować izolację z folii z tworzywa sztucznego.
- SK** Návrhy pre bezpečný základ: Pri príprave základov prosím vykonajte potrebné opatrenia, aby ste zabezpečili, že pod podlahovými profilmi nebude môcť presakovať voda. Stúpajúci zemnej vlhkosti a kondenzácii možno zabrániť použitím silného plastového plechu pod dlažobnými doskami alebo pod betónovým základom.
- SI** Predlogi za varne temelje: Pri pripravi temeljev upoštevajte ustrezne previdnostne ukrepe, da zagotovite, da voda ne more uhajati pod talnimi profili. Naraščajoči vlagi in kondenzaciji tal se lahko izognemo z uporabo močne plastične folije pod tlakovci ali pod betonskim temeljem.
- CZ** Návrhy pro bezpečný základ: Při přípravě základů prosím proveďte nezbytná opatření, abyste zajistili, že pod podlahovými profily nebude moci prosakovat voda. Stoupající zemní vlhkosti a kondenzaci lze zabránit použitím silného plastového plechu pod dlažebními deskami nebo pod betonovým základem.
- HU** Javaslatok az alapzathoz: Az alapzat elhelyezésekor kérem, ügyeljen arra, hogy az esővíz ne juthasson be a padlóprofilok alatt a szerszámtárolóba!! Elkerülheti az emelkedő talajnedvességet és páralecsapódást úgy, hogy egy erős műanyag fóliát helyez az alapzatra.
- HR** Prijedlozi za siguran temelj: Prilikom izrade temelja, poduzmite potrebne mjere predostrožnosti kako biste osigurali da voda ne može procuriti ispod podnih profila. Povećana vlaga i kondenzacija u tlu mogu se izbjeći upotrebom jakog plastičnog lima ispod pločica za popločavanje ili ispod betonskog temelja.

SMARTBASE



SMARTBASE PLUS



BODENRAHMEN KIESBETT

- (GB)** Floor frame gravel bed
- (FR)** Cadre de sol sur lit de gravier
- (NL)** Bodemframe grindbed
- (ES)** Lecho de grava del marco del suelo
- (IT)** Telaio di base letto di ghiaia
- (DK)** Gulvramme grus seng
- (SE)** Bottenram grusbädd
- (NO)** Gulv ramme ujevnbakke
- (PL)** Rama podłogowa na podłożu żwirowym
- (SK)** Spodný rámový štrkový podklad
- (SI)** Talni okvir gramozni tampon
- (CZ)** Štěrkové lože se spodním rámem
- (HU)** Padlókeret kavicságy
- (HR)** Talni okvir pješčani tampon

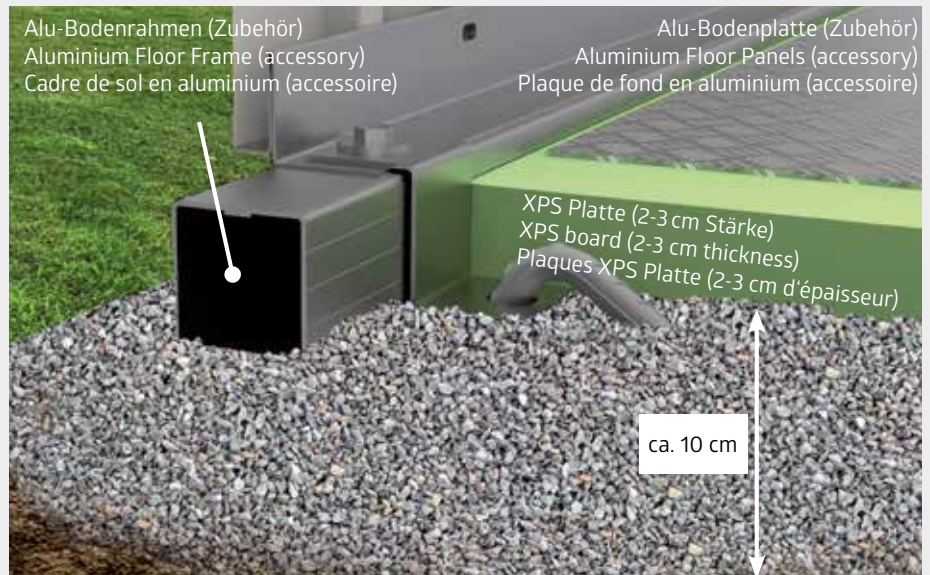

BODENRAHMEN PUNKTFUNDAMENT

- (GB)** Floor frame point foundation
- (FR)** Cadre de sol sur fondation par points
- (NL)** Bodemframe puntfundament
- (ES)** Marco del suelo cimentación puntual
- (IT)** Telaio di base fondazione a plinti di cemento
- (DK)** Gulvramme punkt fundament
- (SE)** Bottenram punktgrund
- (NO)** Gulv ramme punkt fundament
- (PL)** Rama podłogowa na fundamentcie punktowym
- (SK)** Bodové založení
- (SI)** Talni okvir točkovni temelj
- (CZ)** Bodová základna
- (HU)** Padlókeret pontbeton alap
- (HR)** Podni okvir točkasto okvir



BODENRAHMEN GEHWEGPLATTEN

- (GB)** Floor frame paving slabs
- (FR)** Cadre de sol sur dalles en béton
- (NL)** Bodemframe straattegels
- (ES)** Marco del suelo losa de acera
- (IT)** Telaio di base marmettoni in cemento
- (DK)** Gulvramme belægningsplader
- (SE)** Golvkarmsbeläggningssplattor
- (NO)** Gulv ramme belegningsstein
- (PL)** Rama podłogowa na płytach chodnikowych
- (SK)** Chodníkové dosky
- (SI)** Talni okvir tlakovci
- (CZ)** Dlažební desky
- (HU)** Padlókeret járdalapok
- (HR)** Talni okvir tlakovci

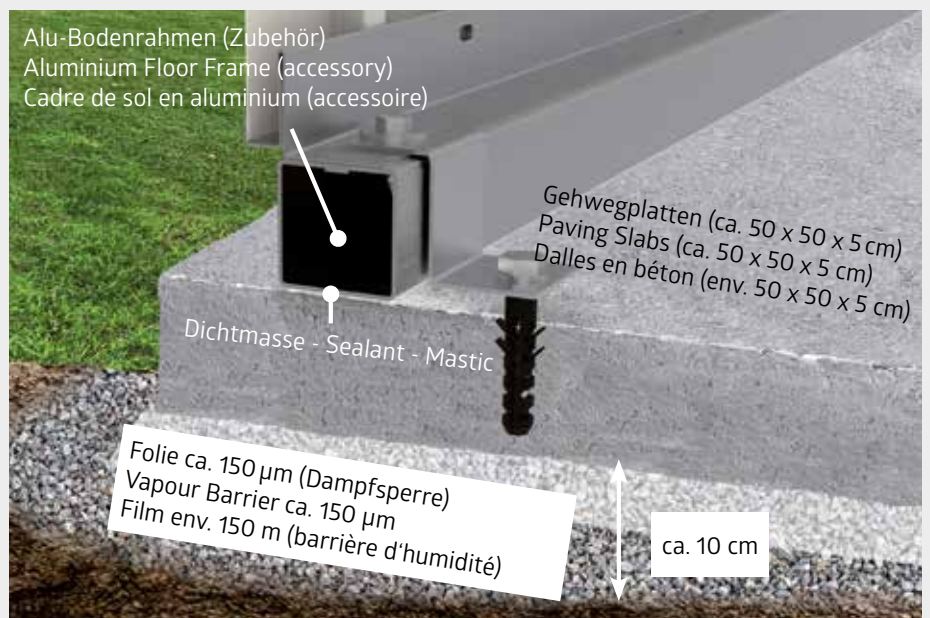

BETONFUNDAMENT MIT ABSTUFUNG

- (GB)** Concrete foundation with step
- (FR)** Fondation en béton avec palier
- (NL)** Betonfundament met gradatie(trede)
- (ES)** Cimentación de hormigón con gradación
- (IT)** Fondazione in calcestruzzo con gradazione
- (DK)** Betonfundament med trin
- (SE)** Betongfundament med steg
- (NO)** Betongfundament med steg
- (PL)** Fundament betonowy ze stopniem
- (SK)** Betónový základ s triedením
- (SI)** Betonski temelj z nastopom
- (CZ)** Betonový základ s odstupňováním
- (HU)** Betonalap lépcsőzetes kialakítással
- (HR)** Betonski temelj sa nastupom



BETONFUNDAMENT OHNE ABSTUFUNG

- (GB)** Concrete foundation without step
- (FR)** Fondation en béton sans palier
- (NL)** Betonfundament zonder gradatie(trede)
- (ES)** Cimentación de hormigón sin gradación
- (IT)** Fondazione in calcestruzzo senza gradazione
- (DK)** Betonfundament uden trin Betongfundament utan steg
- (NO)** Betongfundament uten steg
- (PL)** Fundament betonowy ze stopniem
- (SK)** Betónový základ bez triedenia
- (SI)** Betonski temelj brez nastopa
- (CZ)** Betonový základ bez odstupňování
- (HU)** Betonalap lépcsőzetes kialakítás nélkül
- (HR)** Betonski temelj bez nastupa

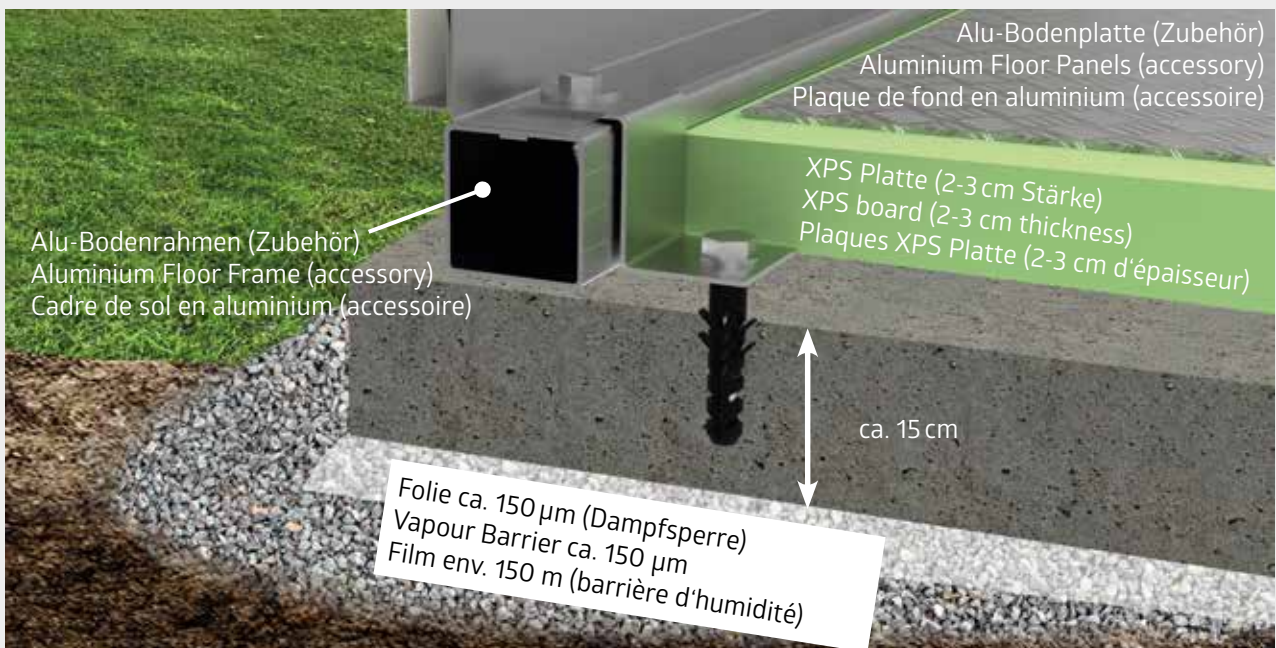

MASSE FÜR DAS BETONFUNDAMENT IN CM

Achtung! Für den Produktaufbau werden mindestens 70 cm Platz rund um das Fundament benötigt!

- (GB)** Dimensions for the concrete foundation in cm! Attention! At least 70 cm space around the foundation are required for assembly of the product!
- (FR)** Dimensions de la fondation de béton en cm. Attention ! Un espace d'au moins 70 cm autour de la fondation est nécessaire pour le montage du produit !
- (NL)** Afmetingen betonfundament in cm! Attentie! Voor de montage van het product heeft u minstens 70 cm ruimte rondom het fundament nodig!
- (ES)** Dimensiones de la cimentación de hormigón en cm. ¡Atención! Para el montaje del producto es necesario un espacio de al menos 70 cm alrededor de los cimientos.
- (IT)** Dimensioni per la fondazione in calcestruzzo in cm! Attenzione! Per il montaggio del prodotto sono necessari almeno 70 cm di spazio intorno alle fondamenta!
- (DK)** Dimensioner for betonfundamentet i cm! Opmærksomhed! Der kræves mindst 70 cm plads omkring fundamentet til montering af produktet!
- (SE)** Mått för betongfundamentet i cm! Uppmärksamhet! Minst 70 cm utrymme runt fundamentet krävs för montering av produkten!
- (NO)** Dimensjoner for betongfundamentet i cm! Merk følgende! Det kreves minst 70 cm mellomrom rundt fundamentet for montering av produktet!
- (PL)** Wymiary fundamentu betonowego w cm! Uwaga! Do montażu produktu wymagane jest co najmniej 70 cm wolnej przestrzeni wokół fundamentu!
- (SK)** Rozmery betónového základu v cm! Pozor! Pri montáži výrobku je potrebný priestor okolo základu minimálne 70 cm!
- (SI)** Mere za betonski temelj v cm! Pozor! Za sestavljanje izdelka je potrebno najmanj 70 cm prostora okoli temelja!
- (CZ)** Rozměry betonového základu v cm! Pozor! Pro montáž výrobku je nutný prostor, alespoň 70 cm kolem základu!
- (HU)** Betonlapzat mérete cm-ben! Figyelem! A termék összeszereléséhez legalább 70 cm hely szükséges az alapzat körül.
- (HR)** Mere za betonski temelj v cm! Pozor! Za sestavljanje izdelka je potrebno najmanj 70 cm prostora okoli temelja!

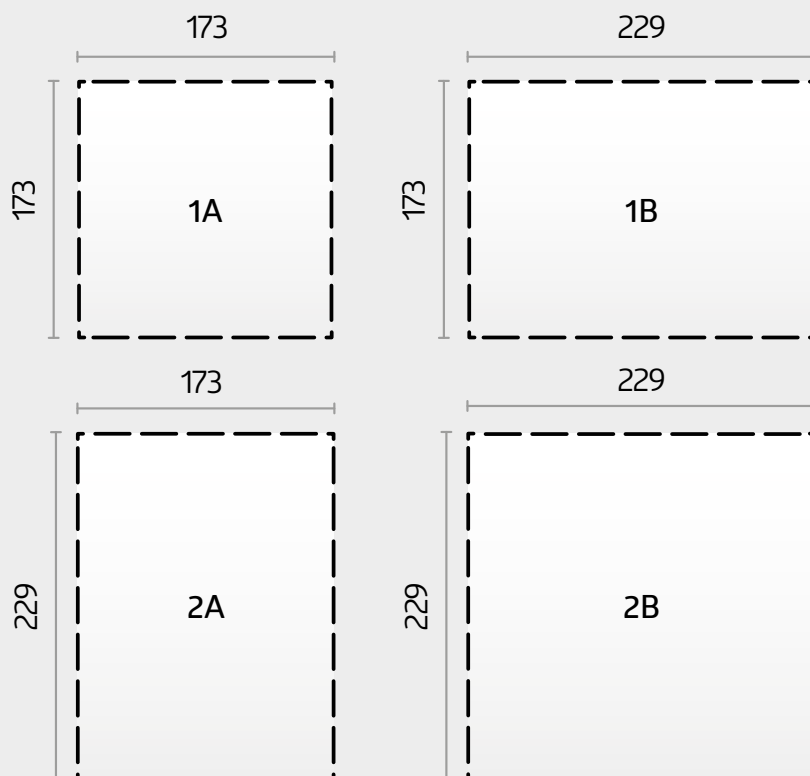

EINBAUMÖGLICHKEITEN DER TÜREN ANSTELLE VON WANDELEMENTEN!

- (GB)** The door can be installed instead of a side wall element!
- (FR)** La porte peut être installée sur le côté à la place d'une paroi latérale !
- (NL)** Inbouwmogelijkheden van de deuren i.p.v. de wandelementen
- (ES)** Es posible colocar las puertas en lugar de los paneles laterales.
- (IT)** Considerare la possibilità di montare una portastandard al posto di una parete laterale!
- (DK)** Døren kan monteres i stedet for et sidevæg element!
- (SE)** Installationsalternativ för dörrar istället för väggelement!
- (NO)** Dør kan installeres i stedet for et sideveggselement!
- (PL)** Opcje montażu drzwi zamiast elementów ściennych!
- (SK)** Dvere je možné nainštalovať miesto dielu bočnej steny!
- (SI)** Vrata lahko namestite namesto stranskega stenskega elementa!
- (CZ)** Dveře lze instalovat místo dílu boční stěny!
- (HU)** Az ajtó beépítési lehetőség a falelemek helyett!
- (HR)** Vrata se mogu ugraditi umjesto elementa bočnog zida!

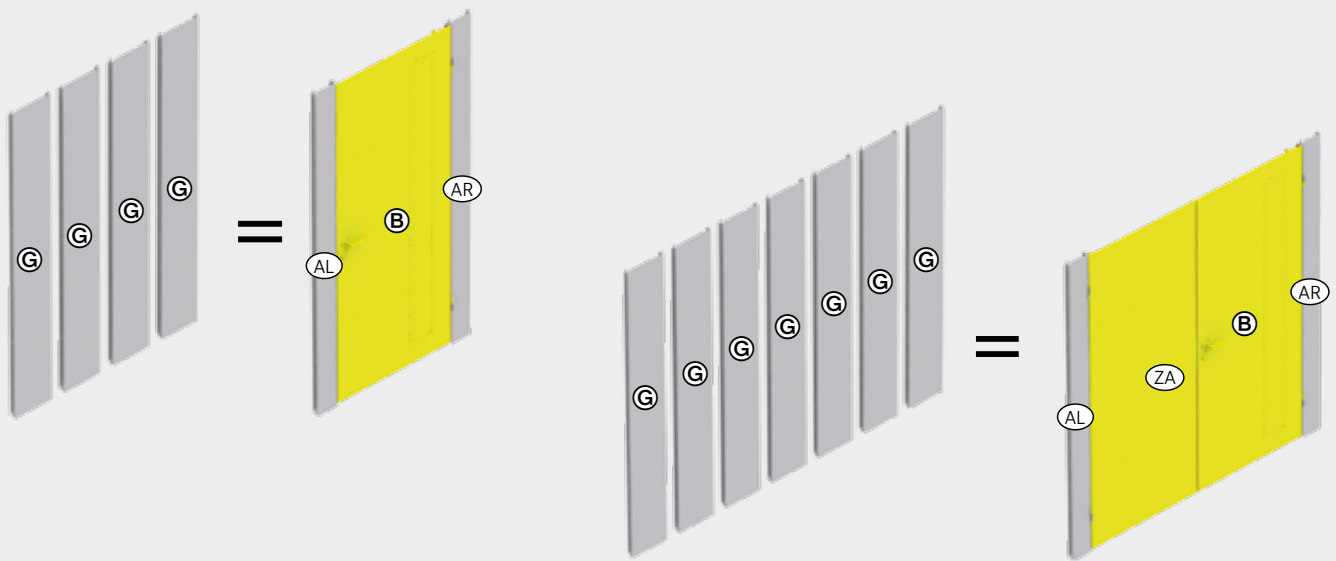

PANEELE MIT PFEILRICHTUNG NACH UNTEN VERBAUEN!

- (GB)** Install the panels with the arrows pointing downwards!
- (FR)** Installez les panneaux en suivant le sens des flèches vers le bas!
- (NL)** Installeer de panelen met de richting van de pijl naar beneden!
- (ES)** ¡Instale los paneles con la dirección de las flechas apuntando hacia abajo!
- (IT)** Installare i pannelli con la direzione delle frecce rivolte verso il basso!
- (DK)** Installer paneler med pilen pegende nedad!
- (SE)** Installera panelerna med pilen nedåt!
- (NO)** Installer panelene med pilene pekende nedover!
- (PL)** Instaluj panele strzałką w dół!
- (SK)** Inštalujte panely tak, aby šípky na nich smerovali dole!
- (SI)** Plošče namestite s puščicami, usmerjenimi navzdol!
- (CZ)** Instalujte panely tak, aby šípky na nich směřovaly dolů!
- (HU)** Építse be a paneleket úgy, hogy a nyíl lefelé nézzen!
- (HR)** Ugradite ploče sa strelicama prema dolje!

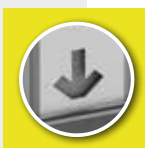
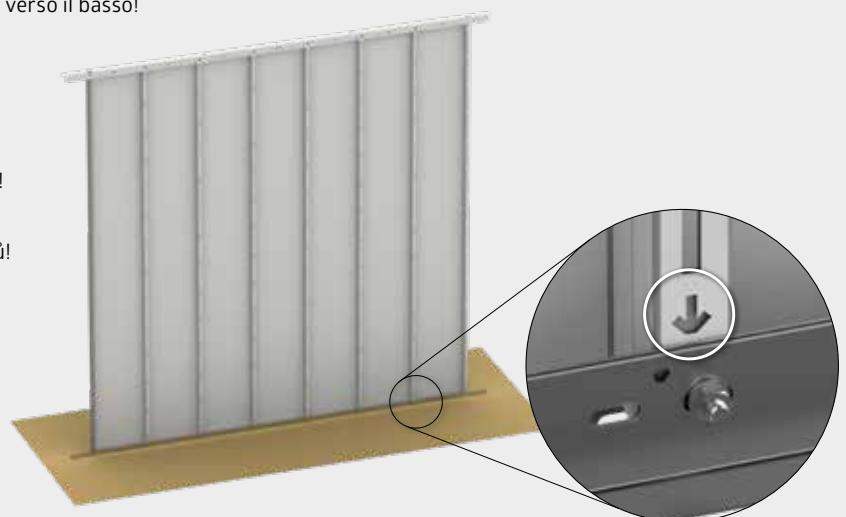

EPDM-DACHFOLIE

Um die Lebensdauer der EPDM-Dachfolie zu verlängern, empfehlen wir die Beschwerung nach dem Aufbau mittels Terrassen-Gehwegplatten oder vergleichbare Beschwerungen (30x30x2/3/4 cm).

- (GB)** EPDM roofing membrane: To extend the life of the EPDM roofing membrane, we recommend weighting it down after installation using concrete slabs or comparable weighting (30x30x2/3/4 cm).
- (FR)** Feuille de toiture EPDM : Afin de prolonger la durée de vie de la feuille de toiture EPDM, nous recommandons de la lester après l'installation en utilisant des dalles de terrasse ou un lestage comparable (30x30x2/3/4 cm).
- (NL)** EPDM-dakfolie: Om de levensduur van de EPDM-dakfolie te verlengen, raden wij aan deze na de installatie te verzwaren met beton tegels of een vergelijkbare verzwaring (30x30x2/3/4 cm).
- (ES)** Lámina de tejado EPDM: Para prolongar la vida útil de la lámina de tejado EPDM, se recomienda lastrarla después de su instalación con losas o similares (30x30x2/3/4 cm).
- (IT)** Telo per tetto EPDM: Per prolungare la durata del telo per tetto EPDM, si consiglia di appesantirlo dopo l'installazione con mattonelle(marmitoni) per pavimenti o pesi simili (30x30x2/3/4 cm).
- (DK)** EPDM-Folie: For at forlænge EPDM-foliens levetid, anbefaler vi at tyngte med terrassefliser eller lignende belastning (30x30x2/3/4cm).
- (SE)** EPDM-takmembran: För att förlänga EPDM-takmembranets livslängd rekommenderar vi att det tyngs ner med uteplatsbeläggningsplattor eller jämförbara vikter (30x30x2/3/4 cm) när det har lagts på plats.
- (NO)** EPDM-takmembran: For å forlenge EPDM-takmembranens levetid, anbefaler vi å holde den nede etter installasjon ved bruk av betongplater eller noe med tilvarende størrelse (30x30x2 / 3/4 cm).
- (PL)** FOLIA DACHOWA EPDM: W celu przedłużenia żywotności membrany dachowej EPDM zalecamy po jej ułożeniu dociążenie płytami chodnikowymi lub o porównywalnym ciężarze (30x30x2 / 3/4 cm).
- (SK)** Strešná EPDM membrána: Pre predĺženie životnosti strešnej EPDM membrány ju odporúčame po montáži zaťažiť pomocou betónových platní alebo porovnateľného zaťaženia (30x30x2/3/4 cm).
- (SI)** EPDM krovna membrana: Da bi podaljšali življenjsko dobo strešne membrane EPDM, priporočamo, da jo po vgradnji obtežite z betonskimi ploščami ali primerljivo utežjo (30x30x2 / 3/4 cm).
- (CZ)** Střešní EPDM membrána: Pro prodloužení životnosti střešní EPDM membrány ji doporučujeme po montáži zatížit pomocí betonových desek nebo srovnatelného zatížení (30x30x2/3/4 cm).
- (HU)** EPDM-tetőfólia: Az EPDM-tetőfólia élettartamának meghosszabbítása érdekében, ajánljuk azt teraszburkoló lapokkal vagy hasonló súlyokkal (30x30x2/3/4 cm) befedni.
- (HR)** EPDM krovna membrana: Da biste produžili vijek trajanja EPDM krovne membrane, preporučujemo je ponderiranje nakon ugradnje betonskim pločama ili sličnim ponderima (30x30x2 / 3/4 cm).

Terrassenplatten

Patio slabs

Dalles en béton

Kies

Gravel

Graviers



Beispiel Größe 1A

Example size 1A

Exemple taille 1A

FÜR ALLE WEITEREN GRÖSSEN FINDEN SIE DETAILS IN DEN FAQ UNTER

www.biohort.com/epdm-dachfolie

- (GB)** For all other sizes you can find details in the FAQ section via www.biohort.com/epdm-dachfolie.
- (FR)** Vous trouverez plus de détails sur les autres tailles dans les FAQ à ce lien : www.biohort.com/epdm-dachfolie
- (NL)** Voor alle andere maten, zie de FAQ op www.biohort.com/epdm-dachfolie voor details.
- (ES)** Para todos los otros tamaños, consulte las preguntas más frecuentes en www.biohort.com/epdm-dachfolie para más detalles.
- (IT)** Per tutte le altre dimensioni, potete trovare i dettagli nelle FAQ sotto www.biohort.com/epdm-dachfolie
- (DK)** For alle andre størrelser kan du finde oplysninger i FAQ på www.biohort.com/epdm-dachfolie
- (SE)** För alla andra storlekar hittar du detaljer i vanliga frågor och svar på <https://www.biohort.com/shop/se/casetta-neo.html>
- (NO)** For alle andre størrelser finner du detaljer i vanlige spørsmål på www.biohort.com/epdm-folie.
- (PL)** Szczegóły dotyczące wszystkich innych rozmiarów znajdziesz w FAQ: www.biohort.com/epdm-dachfolie
- (SK)** Podrobnosti o všetkých ostatných veľkostiach nájdete v častých otázkach na stránke www.biohort.com/epdm-dachfolie
- (SI)** Za vse druge velikosti lahko podrobnosti najdete v pogostih vprašanjih www.biohort.com/epdm-dachfolie.
- (CZ)** Podrobnosti o všech ostatních velikostech naleznete v často kladených dotazech na adrese www.biohort.com/epdm-dachfolie
- (HU)** Minden más méretre vonatkozó részleteket lásd a www.biohort.com/epdm-dachfolie oldalon
- (HR)** Za sve ostale veličine pojednosti možete pronaći u FAQ -u www.biohort.com/epdm-dachfolie.



EINBAUMÖGLICHKEITEN DES LICHTPANEELS ANSTELLE VON WANDELEMENTEN.

Montieren Sie links und rechts neben dem Lichtelement immer ein Wandelement!

Montieren Sie das Lichtpaneel nicht direkt nach einem Eckelement und nicht direkt nebeneinander!

- (GB)** Installation options of the glass panel instead of wall elements. Always install a wall element to the left and right of the glass panel! Do not install the glass panel directly after a corner element or directly next to one another!
- (FR)** Possibilités d'installation du panneau lumineux à la place des éléments muraux. Installez toujours un élément mural à gauche et à droite du panneau lumineux ! Ne montez pas le panneau lumineux directement après un élément d'angle et non plus directement l'un à côté de l'autre !
- (NL)** Montage mogelijkheden van het lichtpaneel ter vervanging van de wandelementen. Plaats altijd een wandelement links en rechts van het lichtelement! Monteer een lichtpaneel niet direct na een hoekelement en niet direct naast elkaar!
- (ES)** Posibilidad de instalación del panel de luz en lugar de los elementos de pared. ¡Siempre debe instalarse un elemento de pared a la izquierda y a la derecha del elemento de iluminación! ¡No monte el panel de luz directamente después de un elemento de esquina y no directamente uno al lado del otro!
- (IT)** Possibilità di installazione del pannello luminoso al posto degli elementi a parete. Installare sempre un elemento a parete a sinistra e a destra dell'elemento di illuminazione! Non montate il pannello luminoso direttamente dopo un elemento angolare o uno accanto all'altro!
- (DK)** Installationsmuligheder for lyspanelet i stedet for vægelementer. Monter altid et vægelement til venstre og højre for lyselementet! Monter ikke lyspanelet direkte efter et hjørneelement og ikke direkte ved siden af hinanden!
- (SE)** Installationsalternativ för ljuspanel istället för väggelement. Montera alltid ett väggelement till vänster och höger om ljuselementet! Montera inte ljuspanelen direkt efter ett hörnelement och inte direkt bredvid varandra!
- (NO)** Installasjonsalternativer for glassplaten i stedet for veggelementer. Installer alltid et veggelement til venstre og høyre for glassplaten! Ikke installer glassplaten rett etter et hjørneelement eller rett ved siden av hverandre!
- (PL)** Możliwości montażu panelu szklanego zamiast elementów ściennych. Zawsze montuj element ścienny z lewej i prawej strony panelu szklanego! Nie montować panelu szklanego bezpośrednio za elementem narożnym i nie bezpośrednio przy sobie!
- (SK)** Možnosti inštalácie skleneného panela namiesto stenových prvkov. Vždy namontujte stenový prvok naľavo aj napravo od skleneného panelu! Neinštalujte sklenený panel vedľa rohov alebo priamo vedľa seba!
- (SI)** Možnosti namestitve steklene plošče namesto stenskih elementov. Stenski element vedno namestite levo in desno od steklene plošče! Steklene plošče ne nameščajte neposredno za vogalnim elementom ali neposredno drug ob drugem!
- (CZ)** Možnosti instalace skleněného panelu namísto stěnových prvků. Vždy namontujte stěnový prvek nalevo i napravo od skleněného panelu! Neinstalujte skleněný panel vedle rohů nebo přímo vedle sebe!
- (HU)** Az üvegelem beépítése a falpanel helyett. Az üvegelem jobb és bal oldalára mindig egy falelem kerüljön! Az üvegelemet ne közvetlenül a sarokelem, illetve egy másik üvegelem mellé építse be!
- (HR)** Mogućnosti ugradnje staklene ploče umjesto zidnih elemenata. Uvijek instalirajte zidni element lijevo i desno od staklene ploče! Ne postavljajte staklenu ploču izravno nakon kutnog elementa ili neposredno jednu do druge!

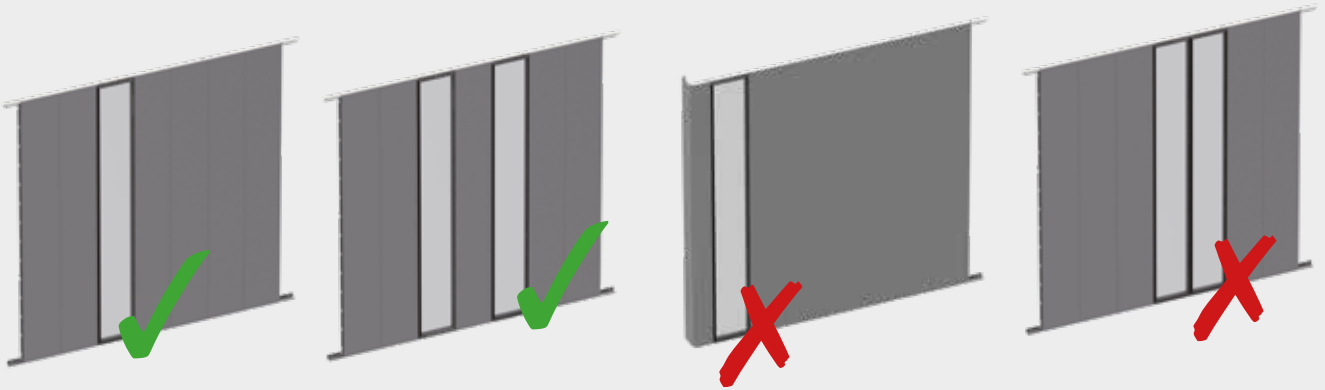



TEILEÜBERSICHT

Parts list · Liste des pièces · Stuklijst · Lista de piezas · Lista de parti · Deloversigt · Delöversikt · Del liste · Przegląd elementów · Zoznam dielov · Seznam delov · Seznam dílů · Tételék áttekintése · Popis dijelova



1 STANDARDTÜR - PAKET

Standard door package · Carton de portes standard · Standaard deurpakket · Puertas estándar · Pacco porta standard · Standarddørpakke

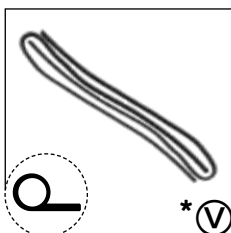
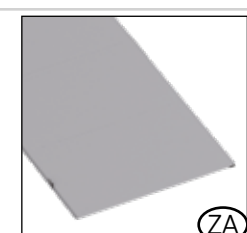
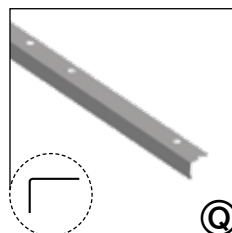
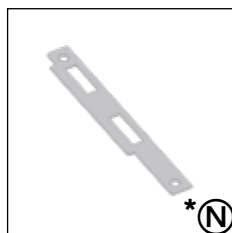
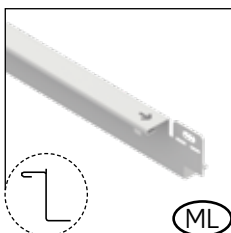
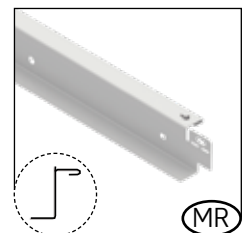
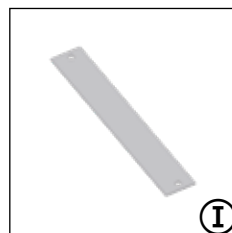
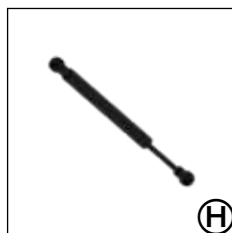
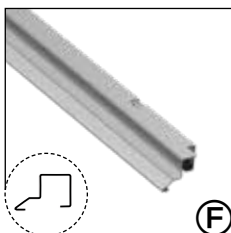
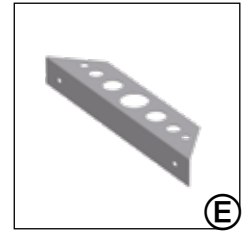
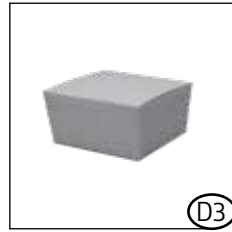
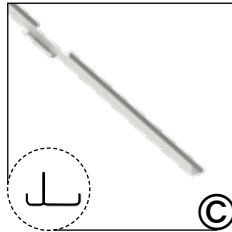
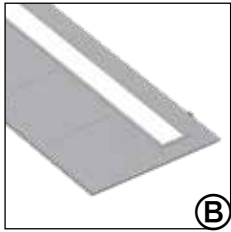

* TEIL ENTFÄLLT BEI DER DOPPELTÜR

- (GB) Part not required when double doors are fitted
- (FR) La pièce est supprimée pour la double portes
- (NL) Deel vervalt bij de dubbele deur
- (ES) Pieza no es necesaria en caso de puerta doble
- (IT) Pezzo non può essere utilizzato per la variante porta a due battenti
- (DK) Del ikke nødvendig med dobbeltdør
- (SE) Den här delen utgår vid dubbelddör
- (NO) Del er ikke nødvendig når dobbeltdør er montert
- (PL) Element nie występuje w drzwiach podwójnych
- (SK) Súčiastka nie je potrebná, ak sú namontované dvojité dvere
- (SI) Del ni potreben, če so nameščena dvojna vrata
- (CZ) Součástka není potřebná, jsou-li namontovány dvojité dveře
- (HU) Ez a tétel a duplaajtó esetén elmarad
- (HR) Rezervni ključ čuvajte odvojeno u slučaju da trebate kopirati

ZUSATZTEILE DOPPELTÜR

double door package · carton de double portes · dubbeldeurpakket · pacco porta doppia · kit de puerta adicional · ekstradele dobbeltdør · extra delar dubbeldörr · dobbeltdør pakke · element dodatkowy dla drzwi podwójnych · balenie dvojkřídlových dveří · paket z dvojnimi vrati · balení dvoukřídlových dveří · tartozék a dupla ajtóhoz · paket s dvostrukim vratima

2 SEITENWAND - PANEELPAKET

Side panel package · Carton de parois latérales · Zijwandpakket · Panel la teral · Pacco pareti laterali · Sidepladepakke · Sidoväggspaket · Side panel pakke · opakowanie zawierające elementy ścienne · Balenie bočného panela · Paket stranske plošče · Balení bočního panelu · Oldalfal csomag · Paket bočne ploče

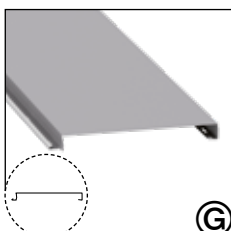

3 PROFIL - PAKET

Profile package · Carton de profils · Profielpakket · Kit de perfiles · Pacco profili · Profilpakke · Profilpaket · Profilpakke · opakowanie zawierające elementy profilowe · Balenie profilov · Profilni paket · Balení profilů · Profilsomag · Paket profila

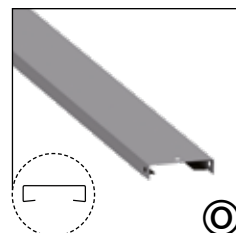
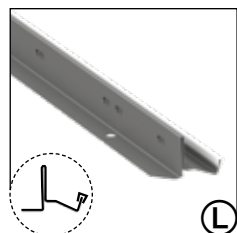
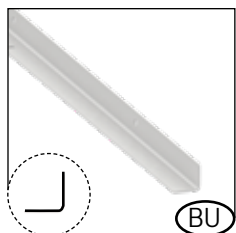
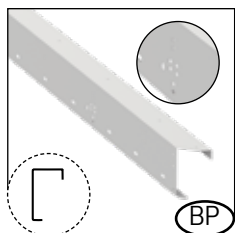
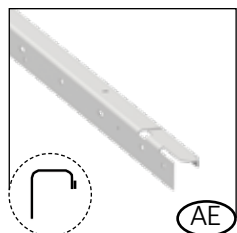

3a PROFIL - PAKET

Profile package · Carton de profils · Profielpakket · Kit de perfiles · Pacco profili · Profilpakke · Profilpaket · Profilpakke · opakowanie zawierające elementy profilowe · Balenie profilov · Profilni paket · Balení profilů · Profilsomag · Paket profila

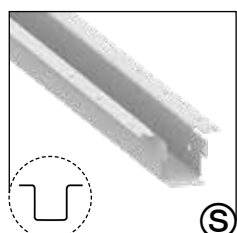
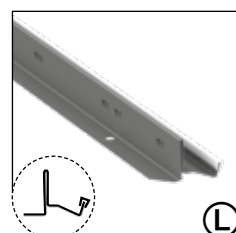
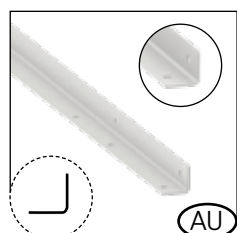
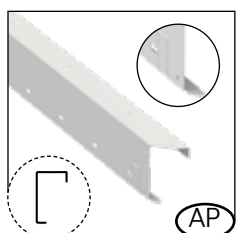
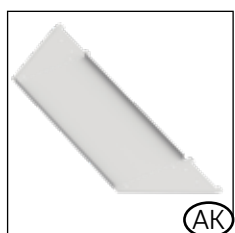
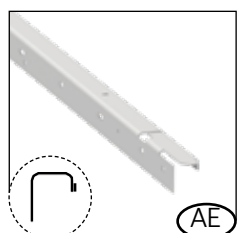

4 DACH - HOLZPAKET

Roof wood package · Colis du plafond en bois · Pakket dakhout · Paquete de madera para el techo · Pacchetto di legno per il tetto · Tag trækasse · Taktråpaket · Tak pakke i tre · Pakiet drewna dachowego · Balík na strechu · Paket lesa za streho · Balíček na strechu · Fa tetőcsomag · Krovni drveni paket



5 DACH - PROFILPAKET

Top profile package · Carton de profils de toit · Dakprofielpaket · Kit de perfiles de tejado · Pacco profili del tetto · Tagprofilpakke · Takprofilpaket · takprofil pakke · opakowanie zawierające profile dachowe · Balenie strešných profilov · Paket strešnih profilov · Balení střešních profilů · Tetőprofil csomag · Paket krovnih profila

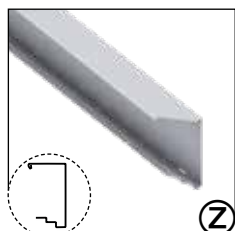

6 DACHFOLIEN - PAKET

Roof membrane package · Colis de la membrane en EPDM pour le toit · Dakfolie pakket · Paquete de láminas para el techo · Pacchetto di lamina per il tetto · Tag-folie pakke · Takfilmspaket · Takfolie pakke · Pakiet membran dachowych · Balík strešných fólií · Paket z membrano za streho · Balíček střešních fólií · Tetőfólia csomag · Paket folija za krov



(R)

7 ECKPANEEL - PAKET

Corner panel package · Colis des parois d'angle · Hoekpaneelpakket · Paquete de paneles de esquina · Pacchetto di pannelli angolari · Hjørnepanel pakke · Hörnpanelpaket · Hjørne panel pakke · Pakiet paneli narożnych · Balík rohových panelov · Paket z kotnim panelom · Balíček rohových panelů · Sarokpanel csomag · Paket kutnih ploča

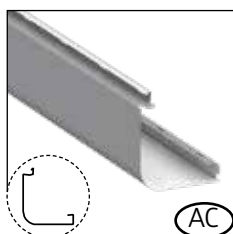

(AC)

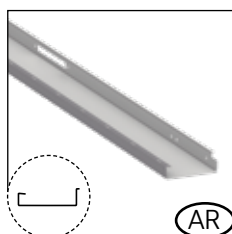

(AR)

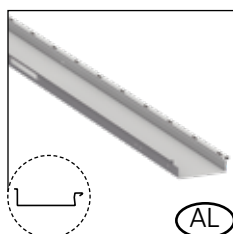

(AL)



(T)

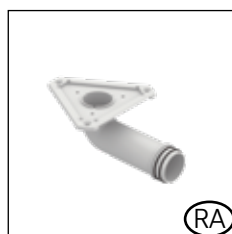

(RA)

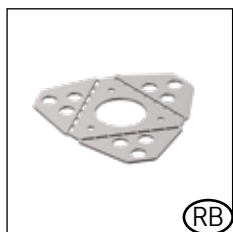

(RB)

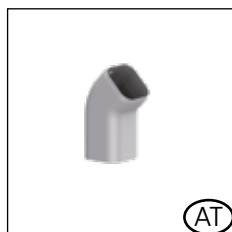

(AT)

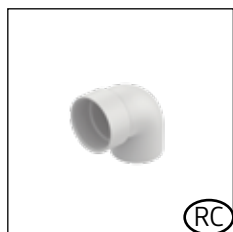

(RC)



(RD)



KLEINTEILEPAKET D2

small parts package · Paquet de petites pièces

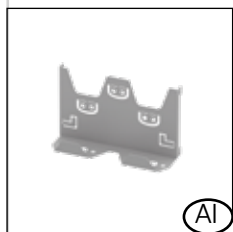

(AI)

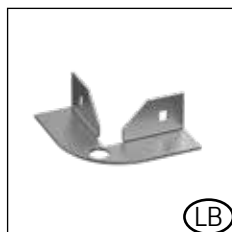

(LB)

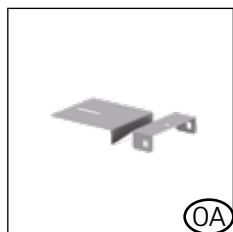

(OA)

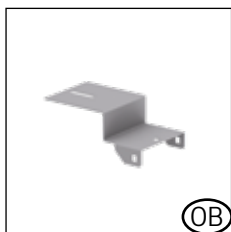

(OB)

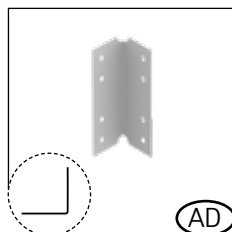

(AD)



(D1)

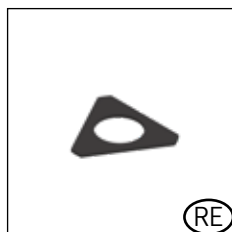

(RE)

BODENRAHMEN - OPTIONAL

Floor frame · Cadre de sol · Bodemframe · Marco de suelo · Telaio perimetrale · Bundramme · Bottenram · Gulvramme · rama podłogowa · Podlahový rám · Podlahový rám · Talni okvir · Padlókeret · Podni okvir

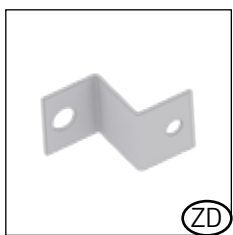
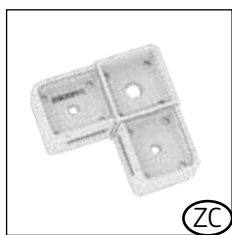

LICHTPANEEL - OPTIONAL

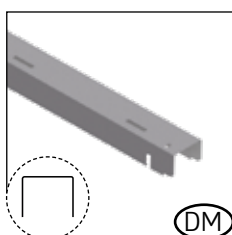

glass panel · Panneau lumineux · Lichtpaneel · panel de cristal · Elemento Vetro · glas panel · glaspanel · glasspanel · panel ze szkła akrylowego · Panel z temperovaného skla · Panel iz Akrilnega Stekla · skleněný panel · Akrilüveg panel · svetlosna ploča







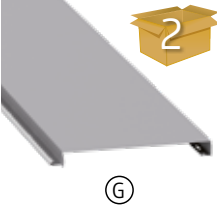

Lichtpaneel

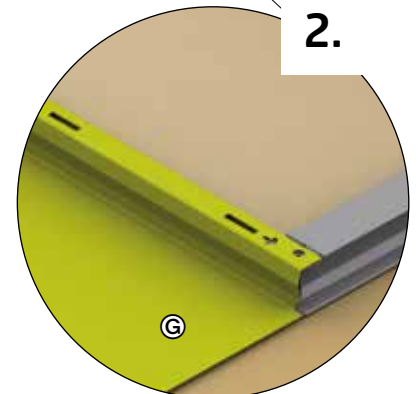
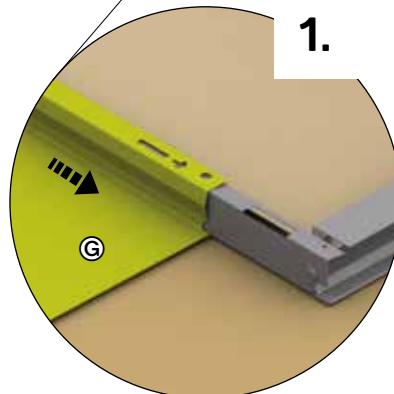
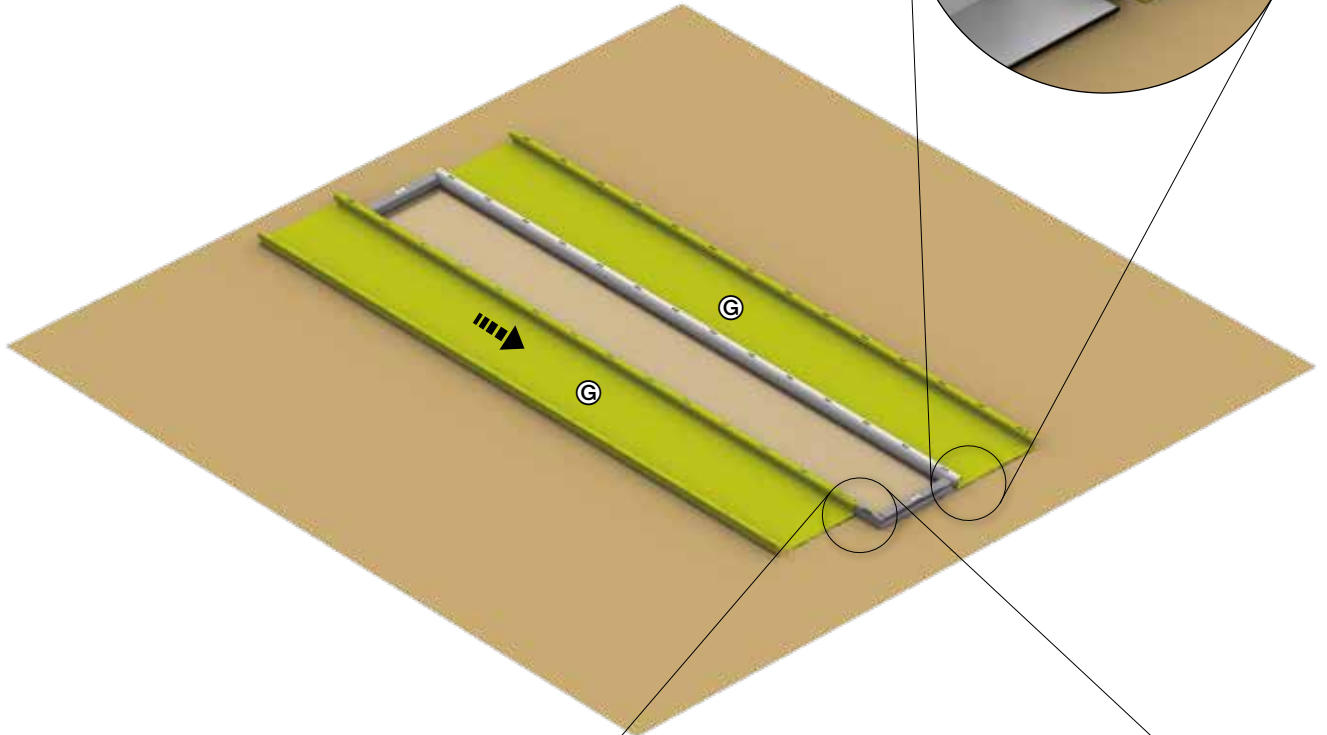
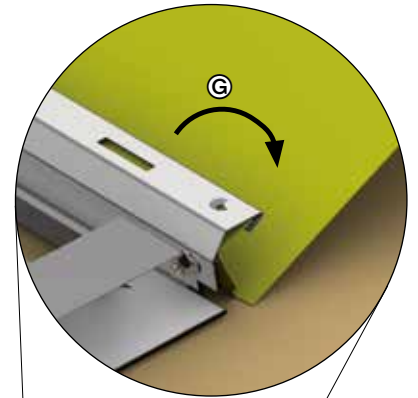
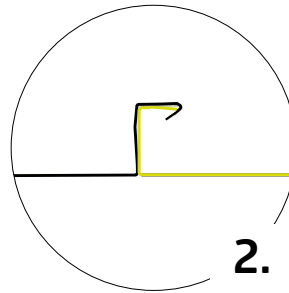
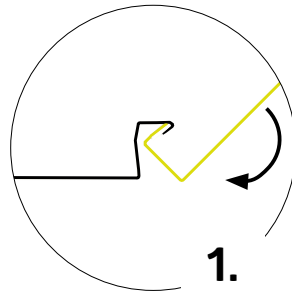
glass panel · Panneau lumineux · Lichtpaneel · panel de cristal · Elemento Vetro · glas panel · glaspanel · glasspanel · panel ze szkła akrylowego · Panel z temperovaného skla · Panel iz Akrilnega Stekla · skleněný panel · Akрилүveg panel · svjetlosna ploča















 <p>ⓐ</p>	1A: 2x	 <p>ⓑ</p>	1A: 1x
	2A: 2x		2A: 1x
	1B: 2x		1B: 1x
	2B: 2x		2B: 1x



M5 x 10		1A: 2x
		2A: 2x
		1B: 2x
		2B: 2x



FESTZIEHEN

-  tighten
-  serrez fort
-  vastdraaien
-  apriete
-  serrare a fondo
-  fastspænding
-  Dra åt
-  Stramme
-  Dokręcić
-  Dotiahnuť
-  Zategnite
-  Dotáhnout
-  Erősen meghúzni
-  Zategnite

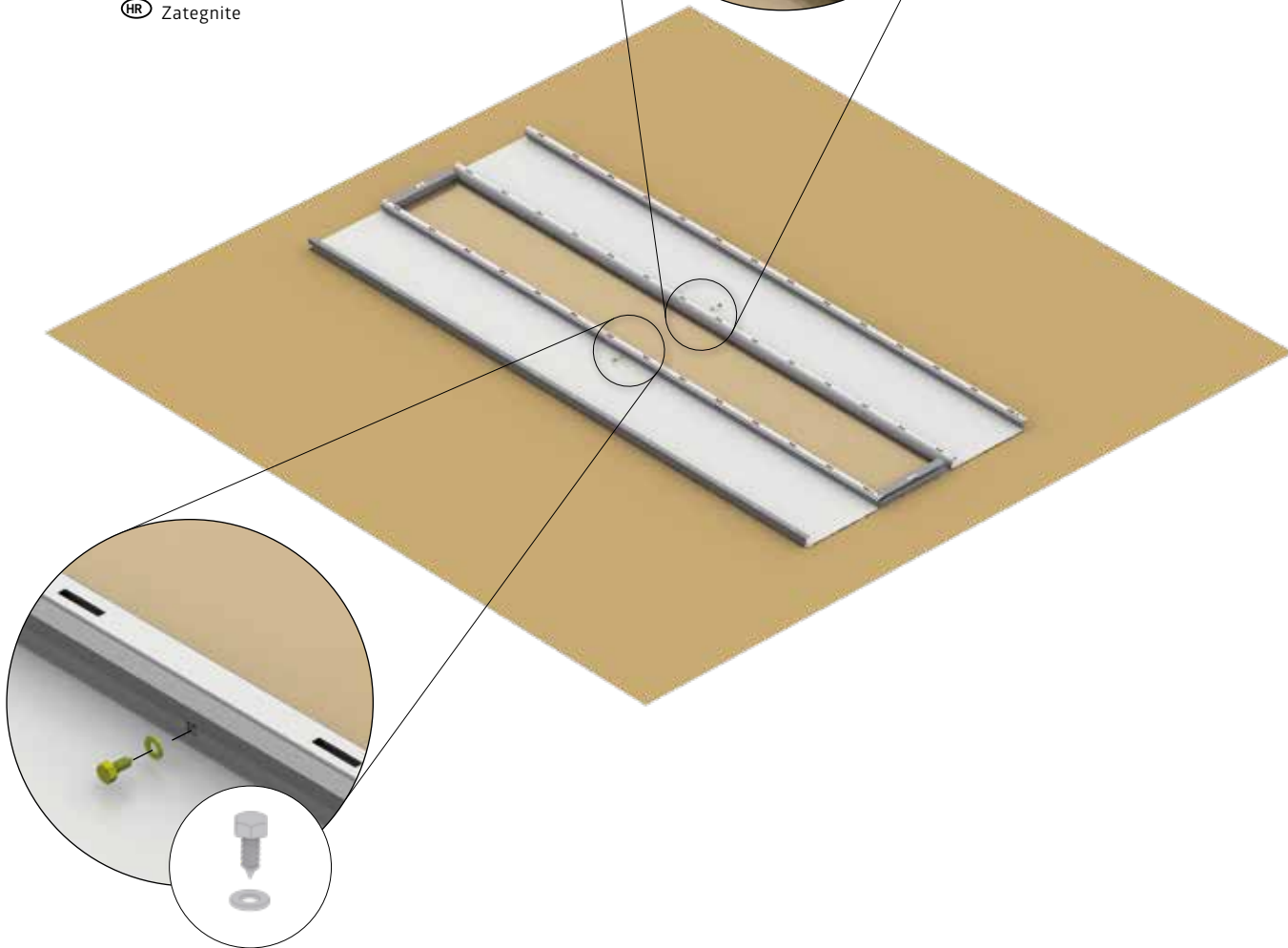
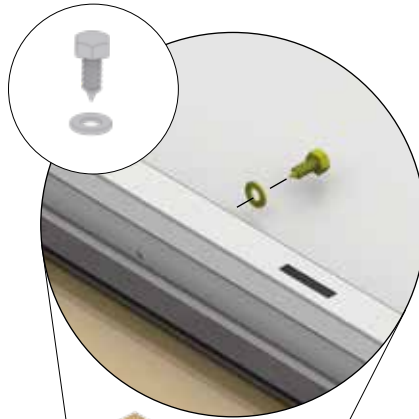



Lichtpaneel

glass panel · Panneau lumineux · Lichtpaneel · panel de cristal · Elemento Vetro · glas panel · glaspanel · glasspanel · panel ze szkła akrylowego · Panel z temperovaného skla · Panel iz Akrilnega Stekla · skleněný panel · Akрилүveg panel · svjetlosna ploča

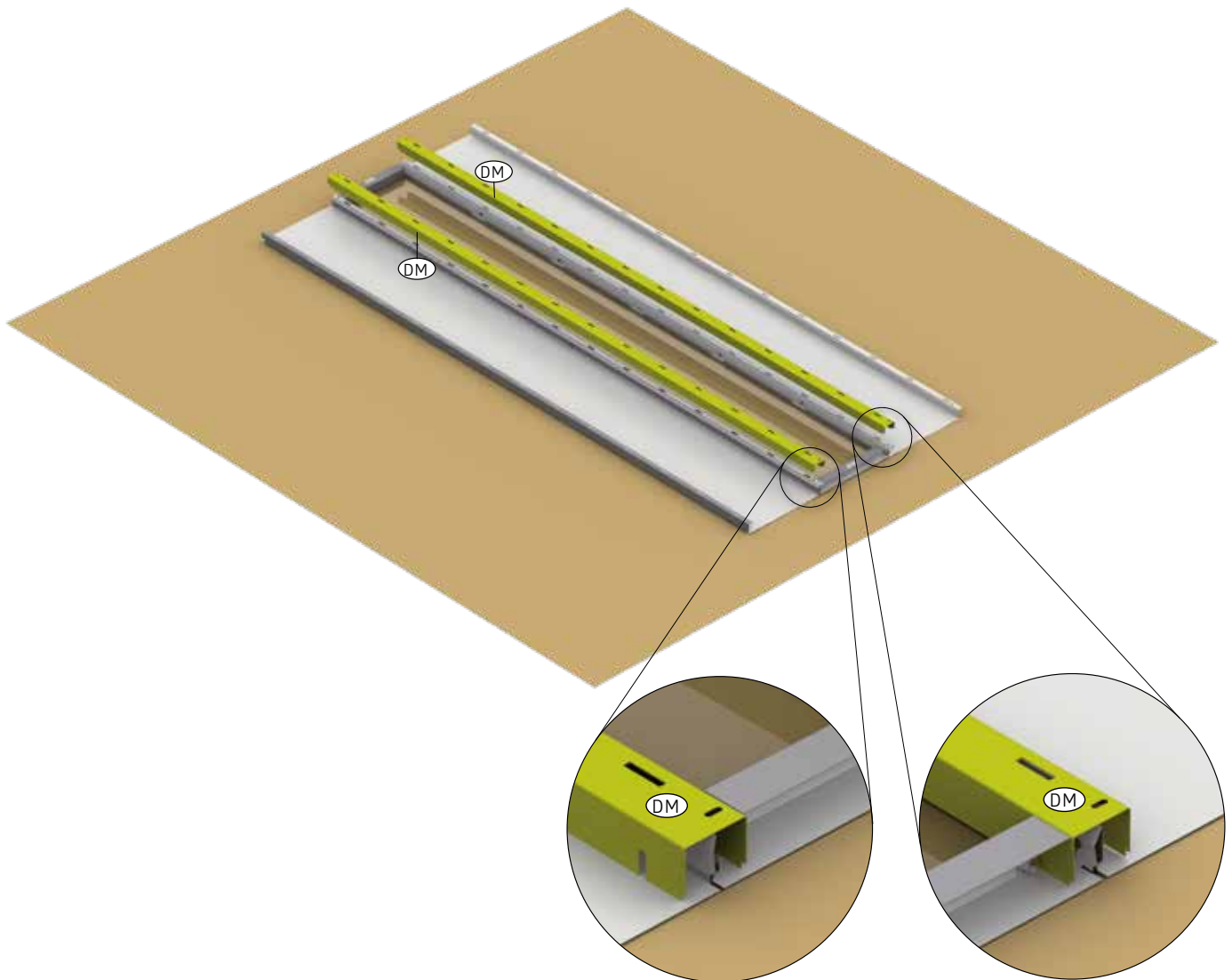
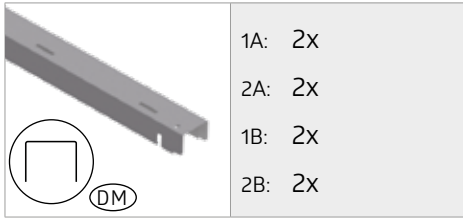

1.

Rückwand

Rear wall - Paroi arrière - Achterwand - Panel posterior - Parete posteriore - Bagplade

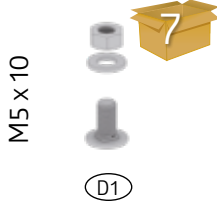
	1A: 5x		1A: 4x
	2A: 5x		2A: 4x
	1B: 7x		1B: 6x
	2B: 7x		2B: 6x

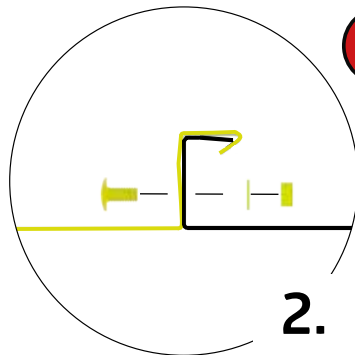
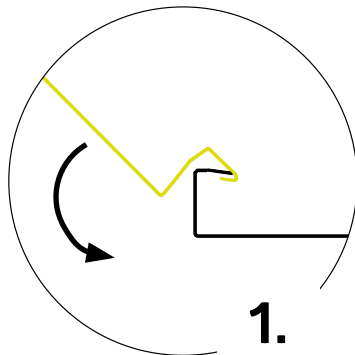

FESTZIEHEN



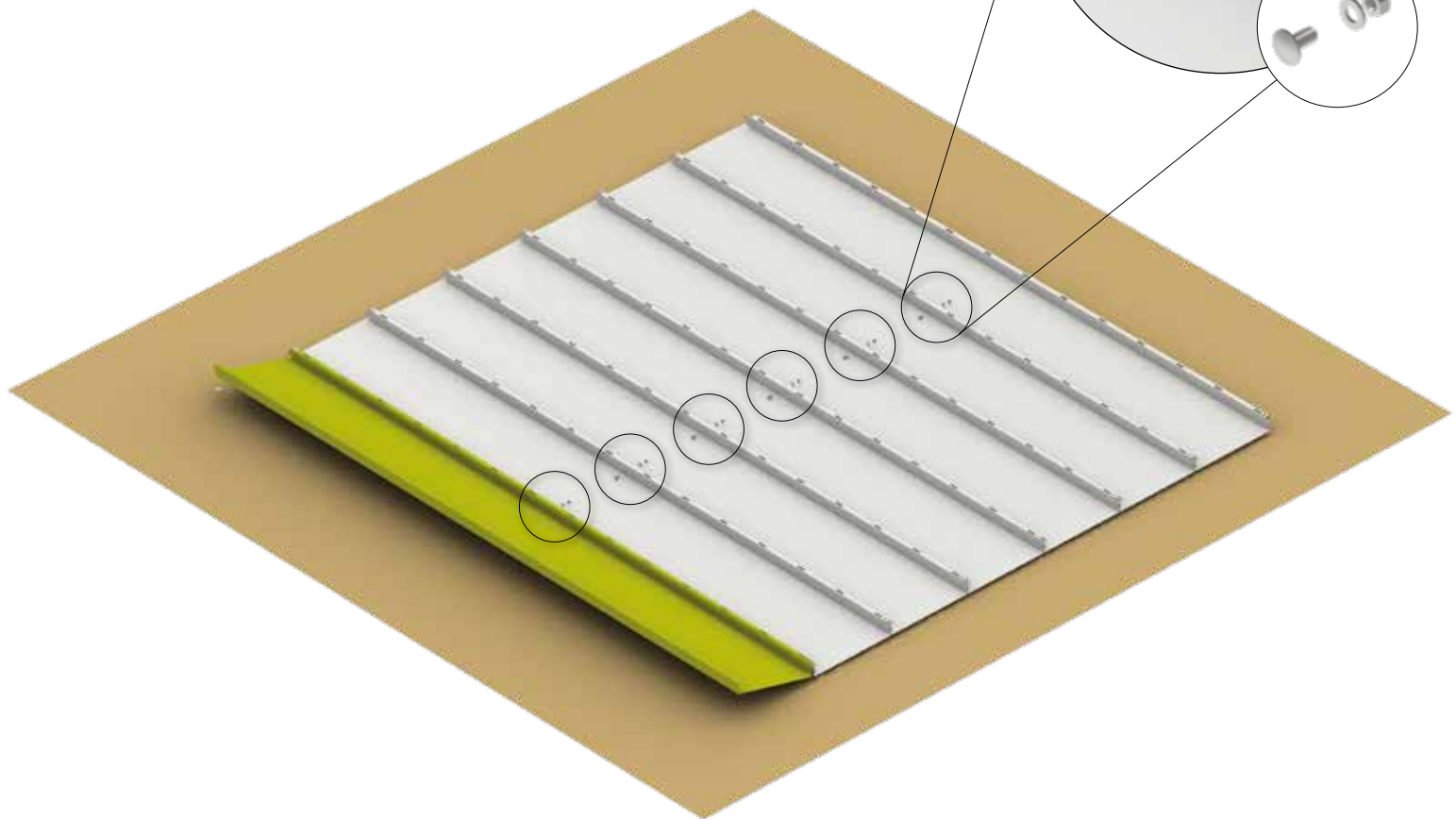
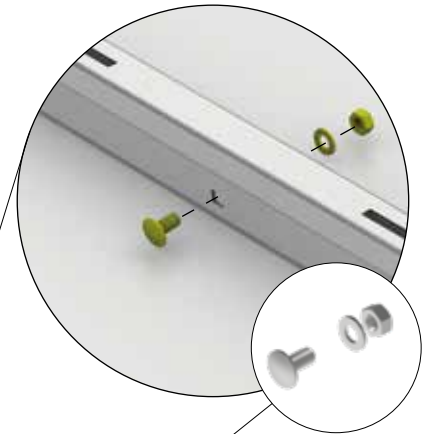



- Ⓒ tighten
- Ⓓ serrez fort
- Ⓔ vastdraaien
- Ⓕ apriete
- Ⓖ serrare a fondo
- Ⓗ fastspænding
- Ⓙ Dra át
- Ⓝ Stramme
- Ⓟ Dokrećić
- Ⓢ Dotiahnuť
- Ⓣ Zategnite
- Ⓒ Dotáhnout
- Ⓔ Erősen meghúzni
- Ⓒ Zategnite



2.

Rückwand

Rear wall · Paroi arrière · Achterwand · Panel posteriore · Parete posteriore · Bagplade · Bakvägg · Bakvegg · Ściana tylna · Zadná stena · Zadnja stena · Zadní stěna · Hátsófal · Stražnji zid



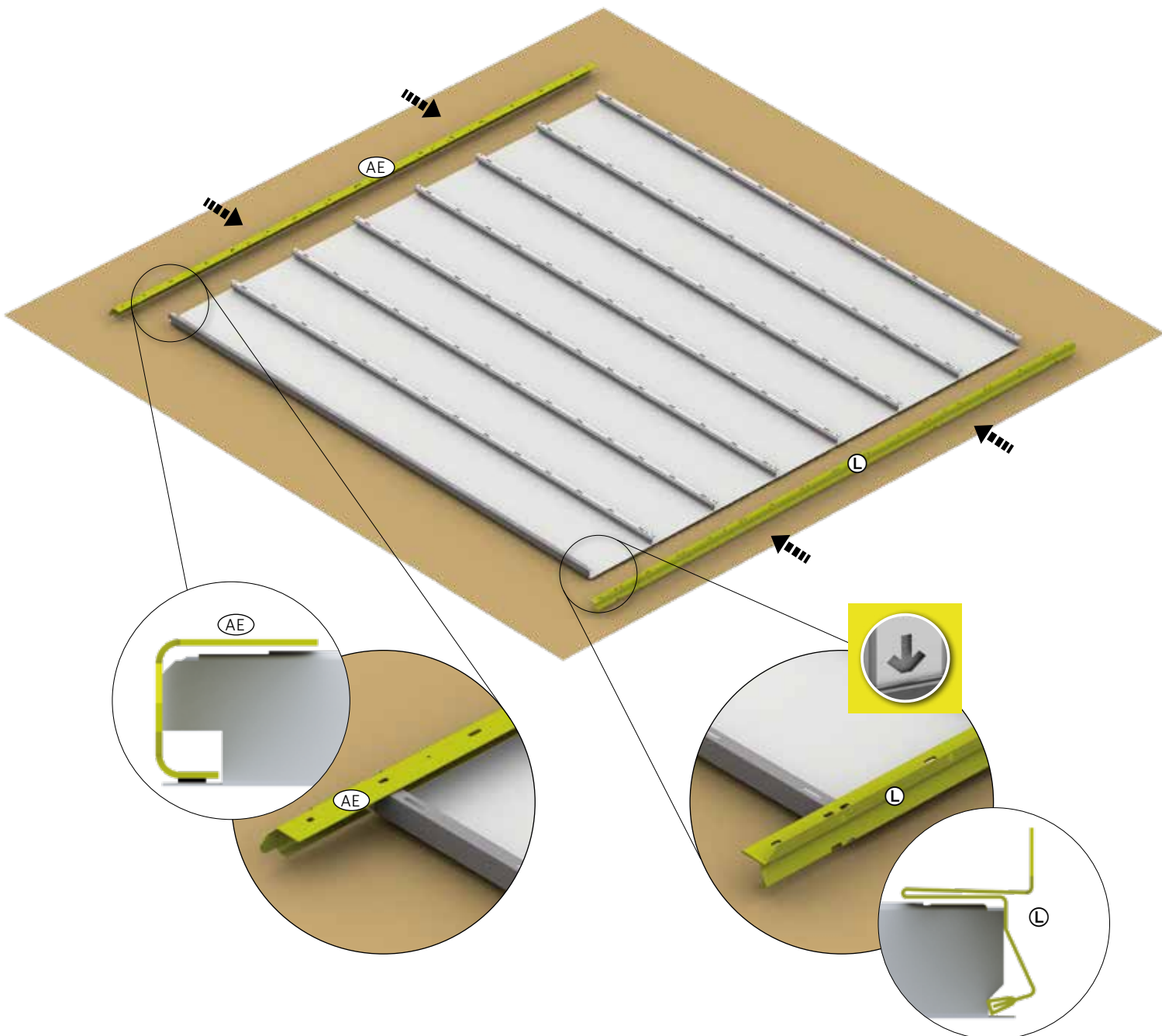

 		1A: 1X (1661 mm) 2A: 1X (1661 mm) 1B: 1X (2221 mm) 2B: 1X (2221 mm)	 		1A: 1X (1631 mm) 2A: 1X (1631 mm) 1B: 1X (2191 mm) 2B: 1X (2191 mm)
--	---	--	--	---	--



3.

Rückwand

Rear wall · Paroi arrière · Achterwand · Panel posterior · Parete posteriore · Bagplade · Bakvägg · Bakvegg · Ściana tylna · Zadná stena · Zadnja stena · Zadní stěna · Hátsófal · Stražnji zid

M5 x 10		1A: 8x	4,8 x 19		1A: 6x
		2A: 8x		2A: 6x	
		1B: 12x		1B: 6x	
		2B: 12x		2B: 6x	

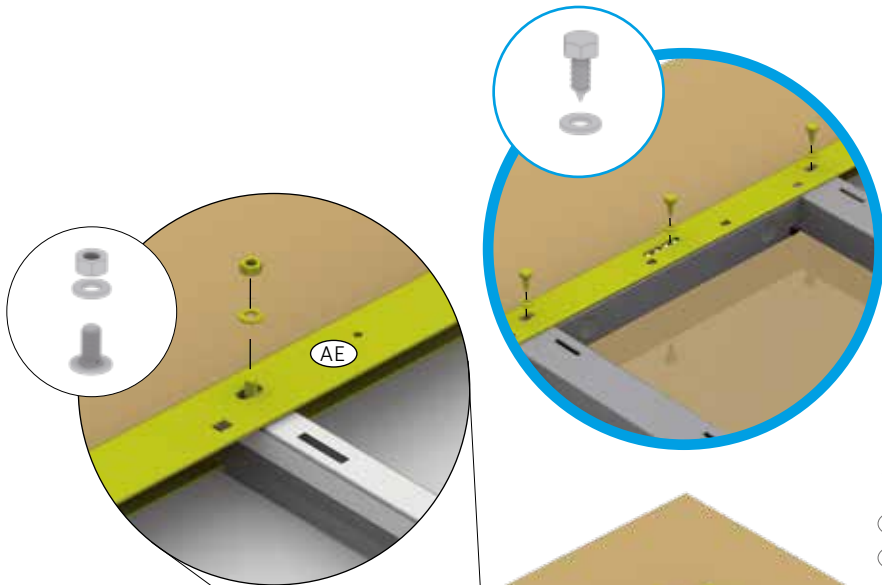

Verschraubung Lichtpaneel

(GB) Screw connection for acrylic glass panel.

(FR) Raccordement à vis pour le panneau lumineux.

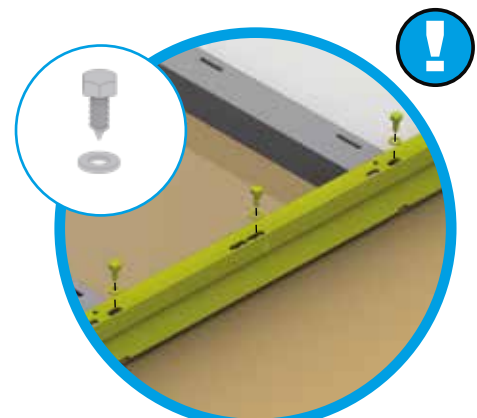
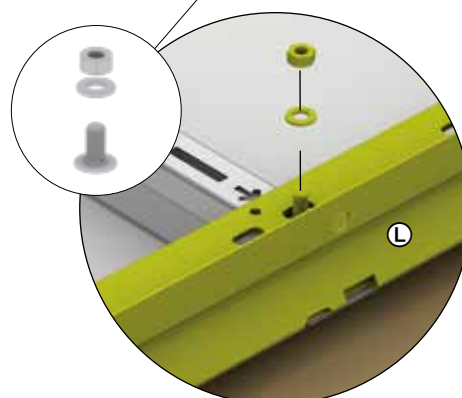
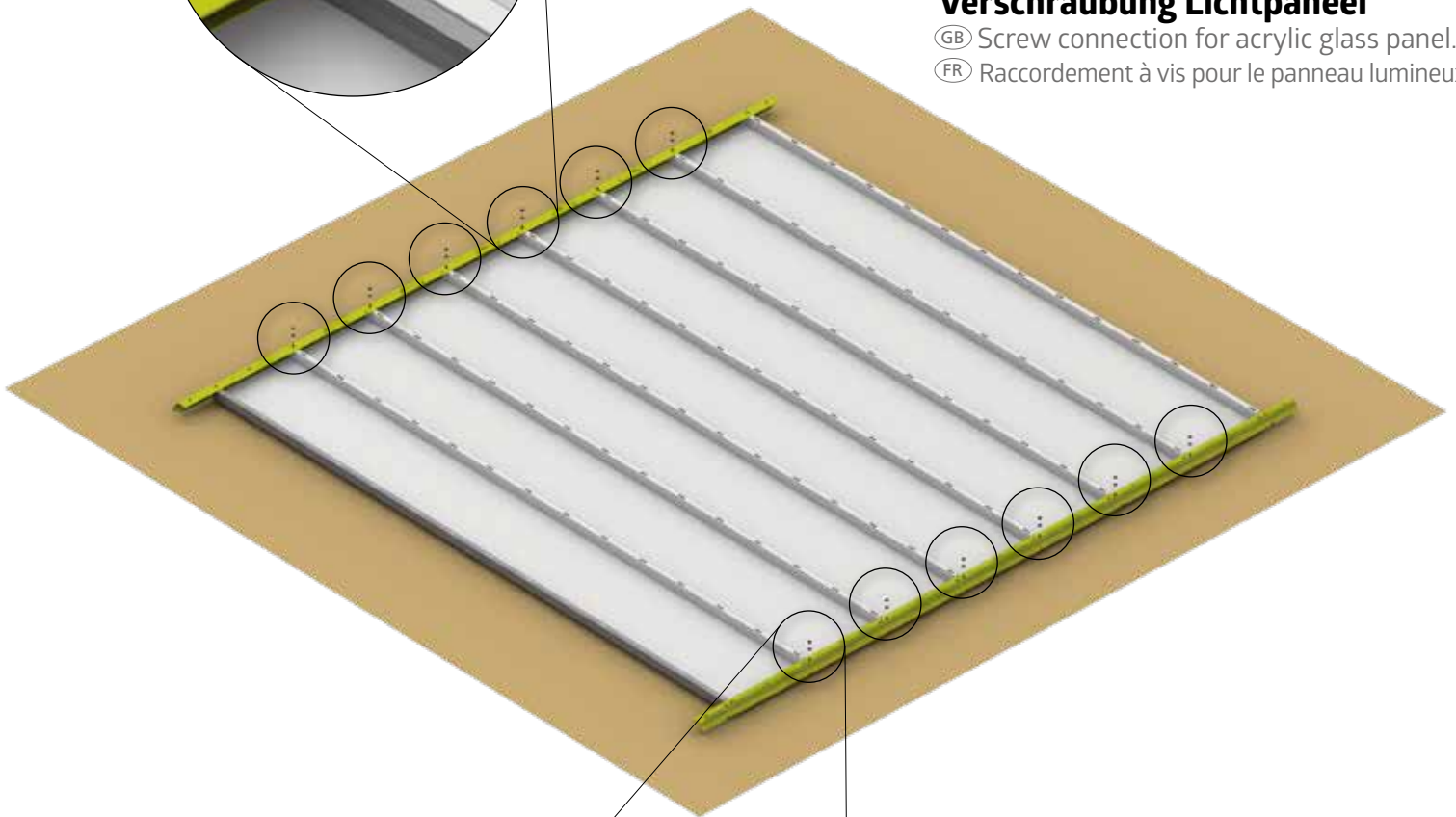

4.

Seitenwand

Side wall - Paroi latérale - Zijwand - panel lateral - Parete laterale - Sideplade - Sidevegg - Ściana boczna - Bočná stena - Stranska stena - Boční stěna - Oldalfal - Boční zid

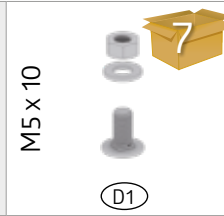
 <p>Ⓒ</p>	1A: 10x	 <p>M5 x 10</p> <p>Ⓓ1</p>	1A: 8x
	2A: 14x		2A: 12x
	1B: 10x		1B: 8x
	2B: 14x		2B: 12x

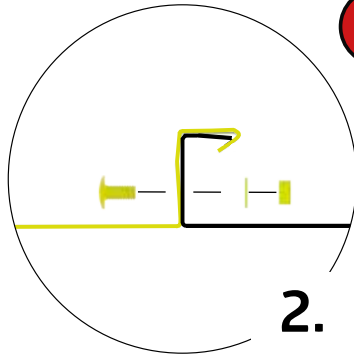
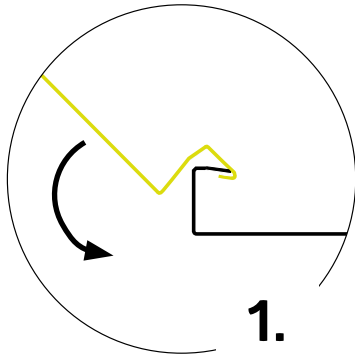

FESTZIEHEN

- ⒸB tighten
- ⒼR serrez fort
- ⒶL vastdraaien
- ⒺS apriete
- ⒾT serrare a fondo
- ⒹK fastspænding
- ⒺE Dra åt
- ⒶO Stramme
- ⒶL Dokręcić
- ⒺK Dotiahnuť
- ⒺI Zategnite
- ⒸZ Dotáhnout
- ⒶU Erősen meghúzni
- ⒶR Zategnite

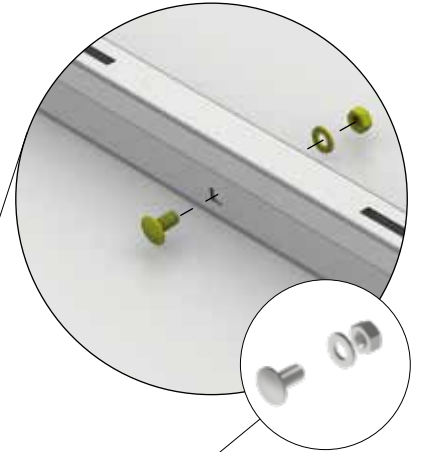



2x

5.

Seitenwand

Side wall - Paroi latérale - Zijwand - panel lateral - Parete laterale - Sideplade - Sideelement - Side vegg - Ściana boczna - Bočná stena - Stranska stena - Boční stěna - Oldalfal - Boční zid

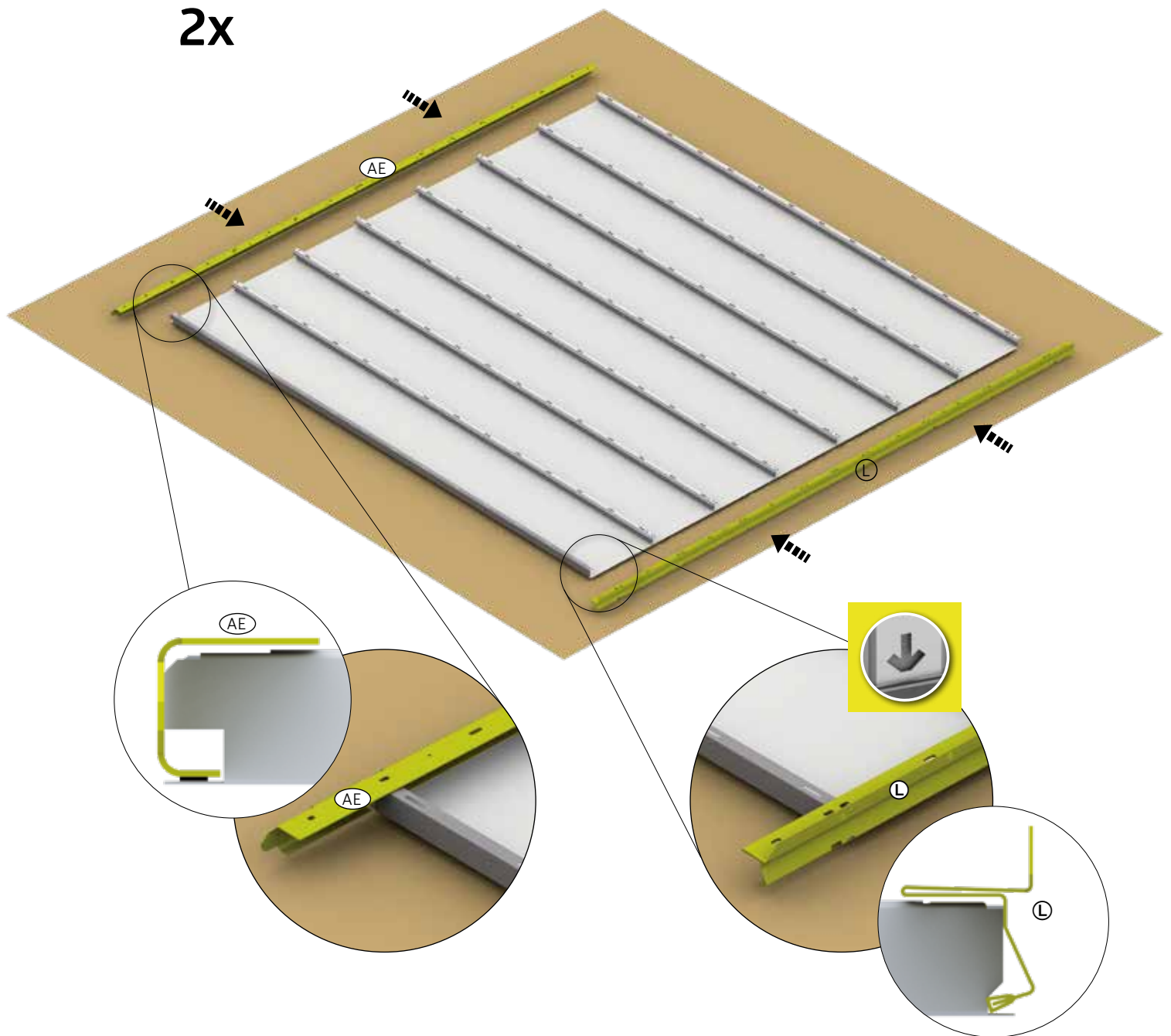

	1A: 2X (1661 mm)		1A: 2X (1631 mm)
	2A: 2X (1661 mm)		2A: 2X (2191 mm)
	1B: 2X (2221 mm)		1B: 2X (1631 mm)
	2B: 2X (2221 mm)		2B: 2X (2191 mm)



6.

Seitenwand

Side wall - Paroi latérale - Zijwand - panel lateral - Parete laterale - Sideplade - Sidevegg - Ściana boczna - Bočná stena - Stranska stena - Boční stěna - Oldalfal - Boční zid

 <p>7</p> <p>1A: 4x 2A: 4x 1B: 4x 2B: 4x</p> <p>(AD)</p>	<p>M5 x 10</p>  <p>7</p> <p>1A: 20x 2A: 28x 1B: 20x 2B: 28x</p> <p>(D1)</p>	<p>4,8 x 19</p>  <p>1A: 6x 2A: 6x 1B: 6x 2B: 6x</p>
---	--	--

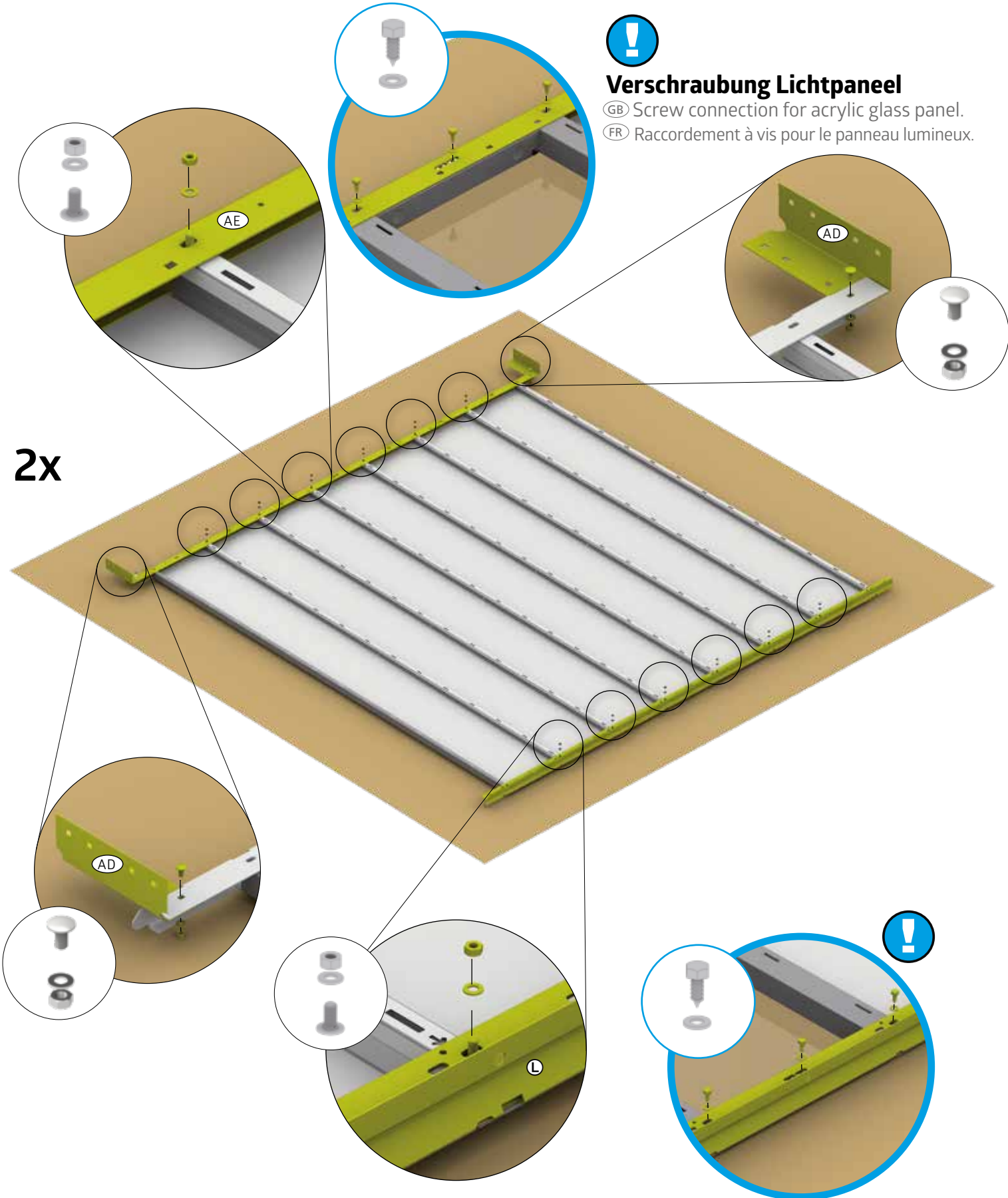



Doppeltür Vorderwand

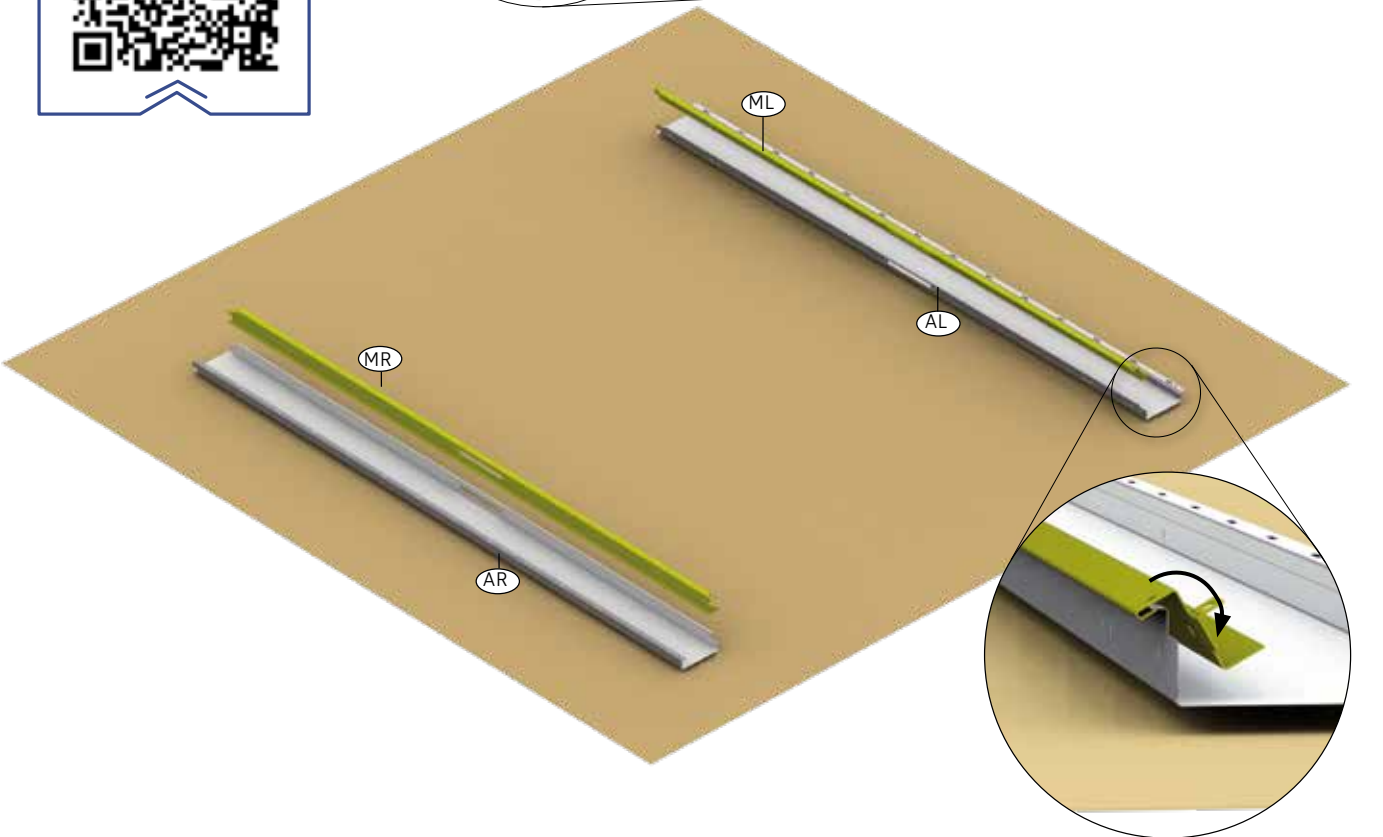
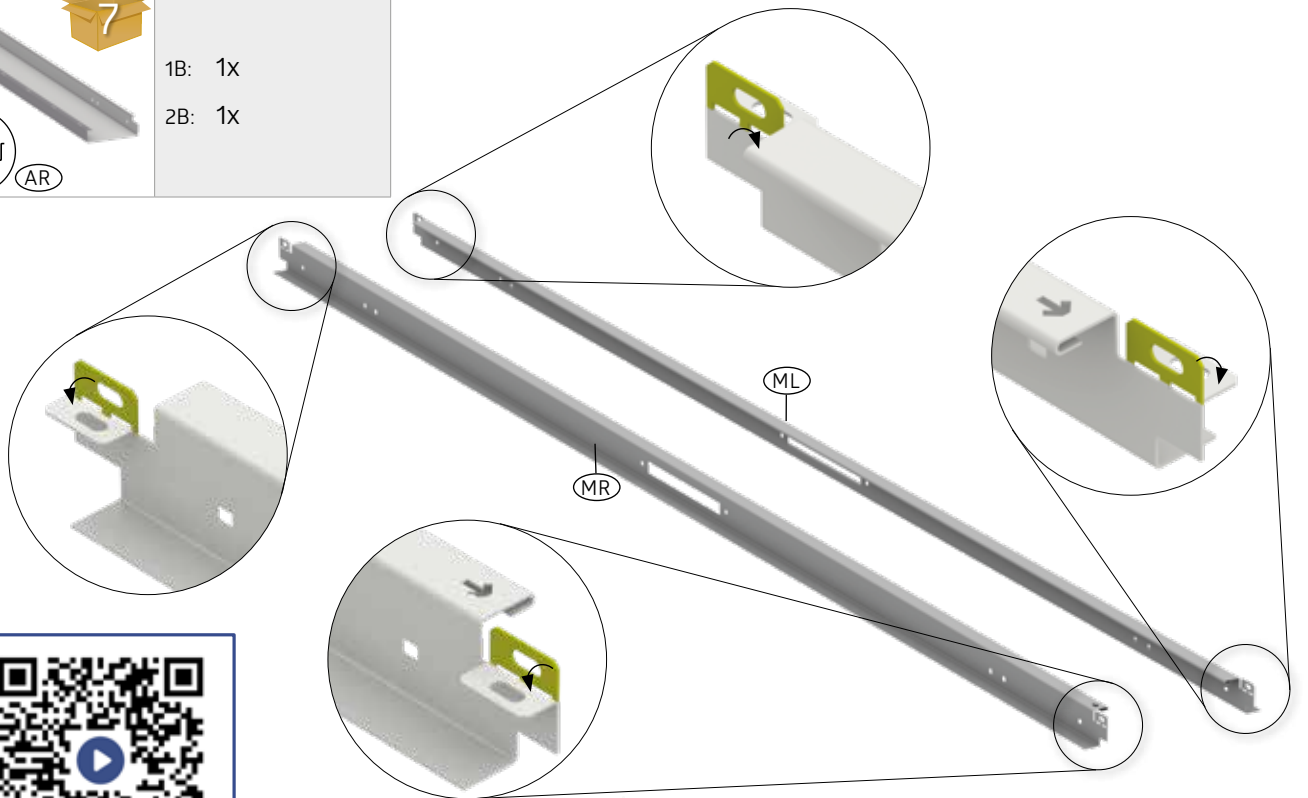
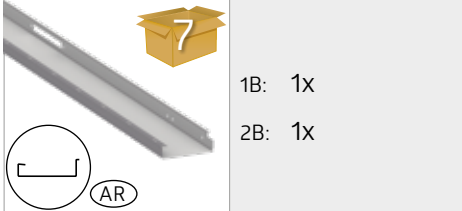
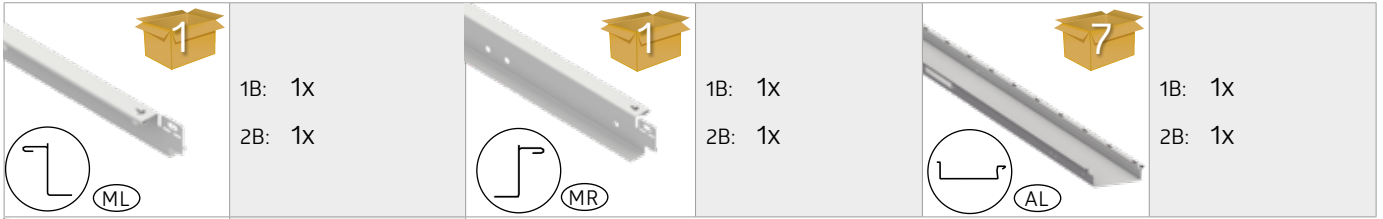

Double Door-front wall - Double porte-paroi frontale - Dubbele deur-voorwand - Doble puerta-pared frontal - Doppia porta-parete anteriore - Dobbeldør-forvæg - Dubbeldörr-framvägg - Dobbelt dør-front vegg - Podwójne drzwi-ściana przednia - Dvojkřídlové dveře-předná stěna - Dvojna vrata-sprednja stena - Dvokřídle dveře-přední stěna - Kettős ajtó-elülső fal - Dvokrilna vrata-prednji zid





Doppeltür Vorderwand

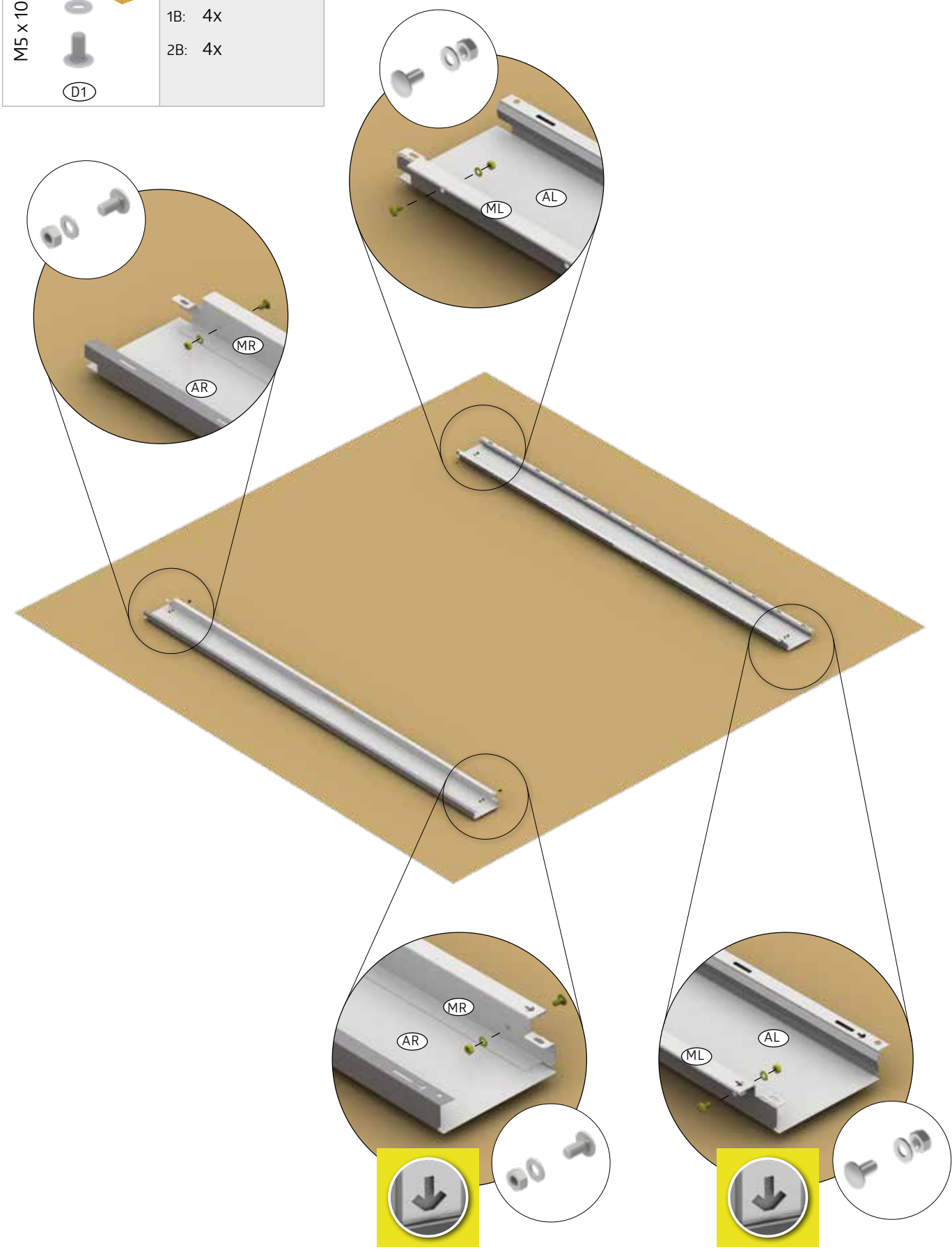

Double Door-front wall - Double porte-paroi frontale - Dubbele deur-voorwand - Doble puerta-pared frontal - Doppia porta-parete anteriore - Dobbeldør-forvæg - Dubbeldörr-ramvägg - Dobbelt dør-front vegg - Podwójne drzwi-ściana przednia - Dvojkřídlové dveře-předná stěna - Dvojna vrata-sprednja stena - Dvoukřídle dveře-přední stěna - Kettős ajtó-elülső fal - Dvokrilna vrata-prednji zid

M5 x 10		7	1B: 4x
			2B: 4x
			(D1)

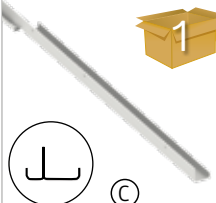
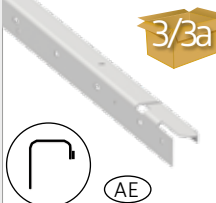

Doppeltür Vorderwand

Double Door-front wall - Double porte-paroi frontale - Dubbele deur-voorwand - Doble puerta-pared frontal - Doppia porta-parete anteriore - Dobbeldør-forvæg - Dubbeldörr-ramvägg - Dobbelt dør-front vegg - Podwójne drzwi-ściana przednia - Dvojkřídlové dveře-předná stěna - Dvojna vrata-sprednja stena - Dvoukřídle dveře-přední stěna - Kettős ajtó-elülső fal - Dvokrilna vrata-prednji zid

 <p>1B: 1X (1619 mm) 2B: 1X (1619 mm)</p>	 <p>1B: 1X 2B: 1X</p>	<p>M5 x 10</p> 	<p>7</p> <p>1B: 4X 2B: 4X</p>
---	--	--	-----------------------------------

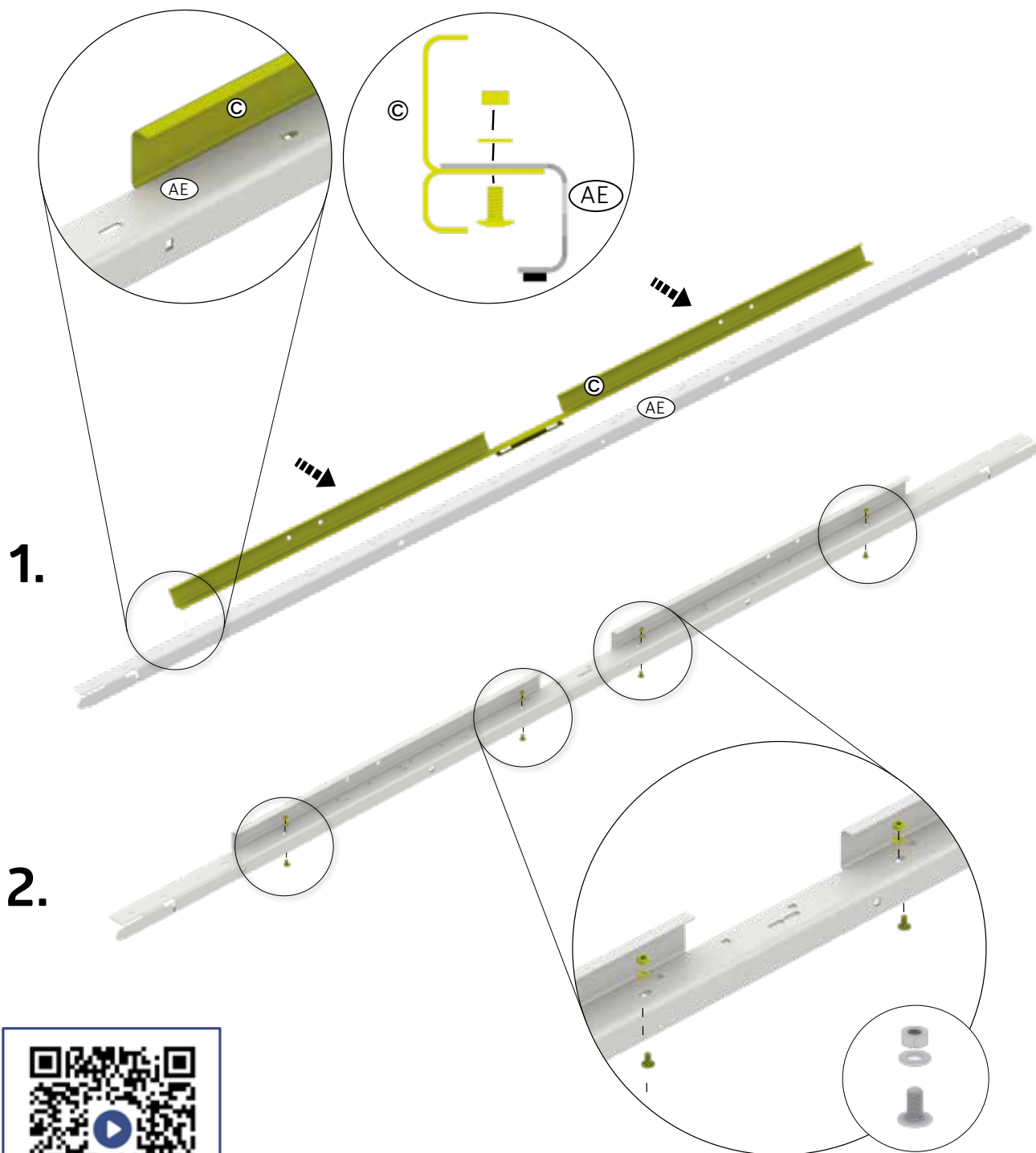



Doppeltür Vorderwand

Double Door-front wall - Double porte-paroi frontale - Dubbele deur-voorwand - Doble puerta-pared frontal - Doppia porta-parete anteriore - Dobbeldør-forvæg - Dubbeldörr-ramvägg - Dobbelt dør-front vegg - Podwójne drzwi-ściana przednia - Dvojkřídlové dveře-předná stěna - Dvojna vrata-sprednja stena - Dvoukřídle dveře-přední stěna - Kettős ajtó-elülső fal - Dvokrilna vrata-prednji zid

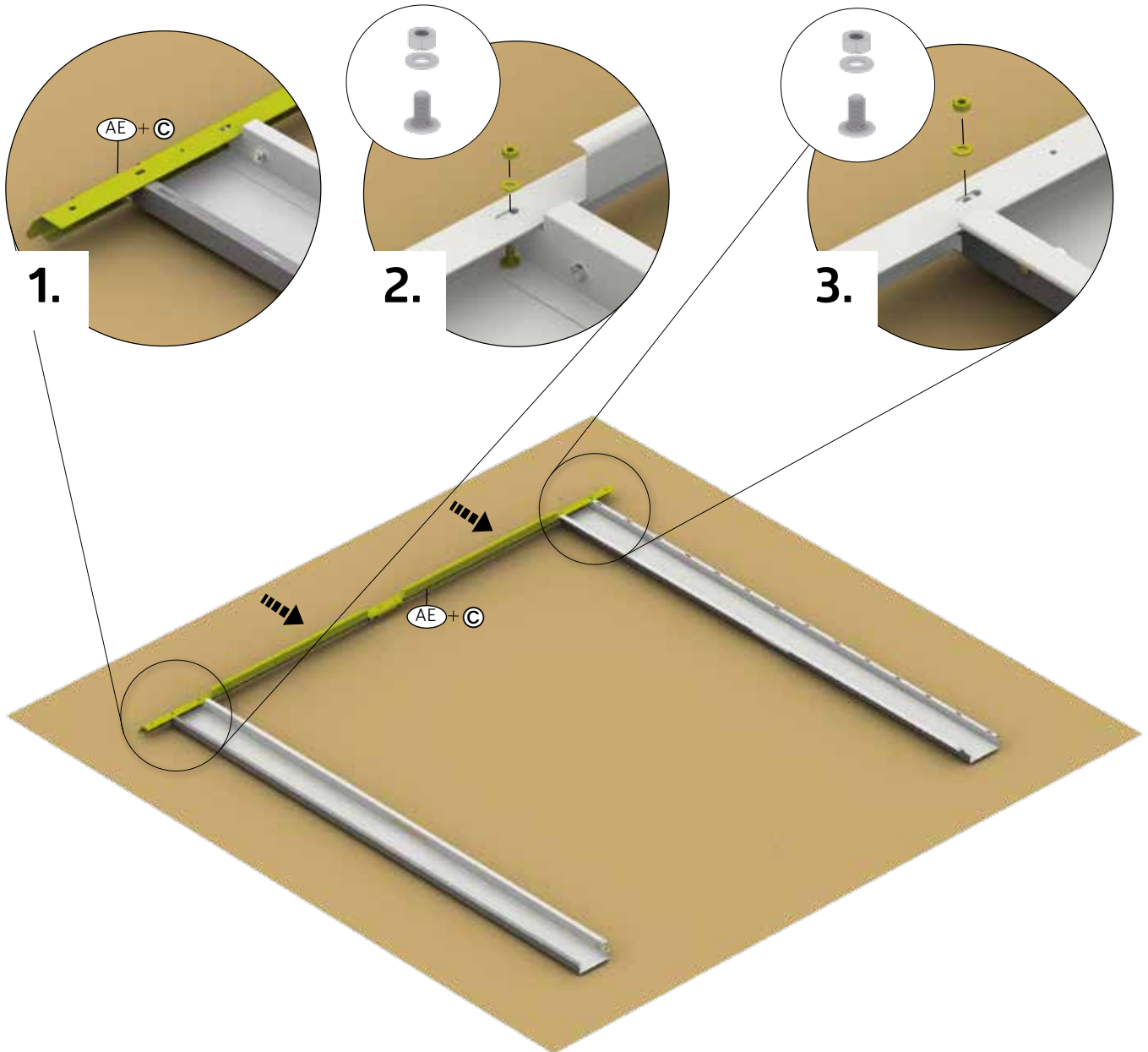
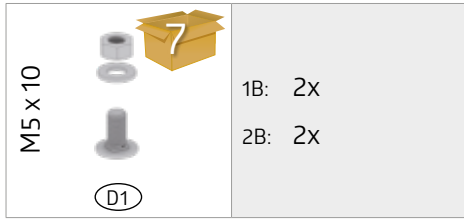

Doppeltür Vorderwand

Double Door-front wall - Double porte-paroi frontale - Dubbele deur-voorwand - Doble puerta-pared frontal - Doppia porta-parete anteriore - Dobbeldør-forvæg - Dubbeldörr-framvägg - Dobbelt dør-front vegg - Podwójne drzwi-ściana przednia - Dvojkřídlové dveře-předná stěna - Dvojna vrata-sprednja stena - Dvoukřídle dveře-přední stěna - Kettős ajtó-elülső fal - Dvokrilna vrata-prednji zid

  	 1B: 1x 2B: 1x	M5 x 10   	1B: 2x 2B: 2x

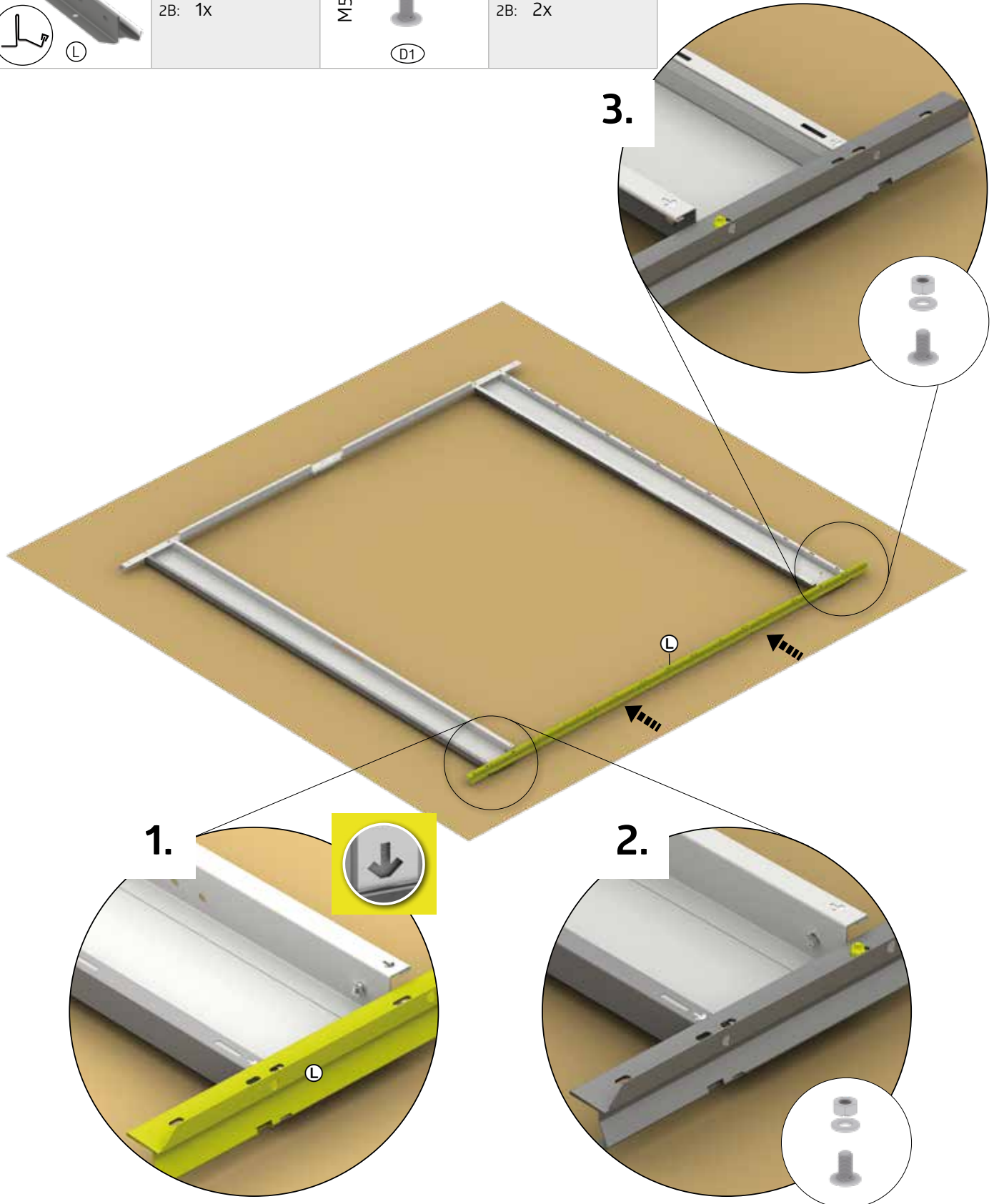

1.

2.

3.

7.

Standardtür - Vorderwand

Standard door-front wall - Porte standard-paroi frontale - Standaard deur-voorwand- Puerta estándar-pared frontal - Porta standard-parete anteriore - Standarddør-frontvæg - Standarddörr-ramvägg - Standard dør-front vegg - Drzwi standardowe-ściana przednia - Štandardné dvere-predná stena - Standardna vrata-sprednja stena - Standardní dveře-přední stěna - Standard ajtó-elülső fal - Standardna vrata-prednji zid

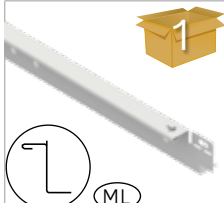
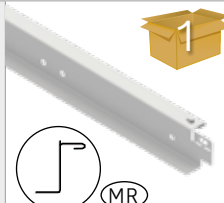
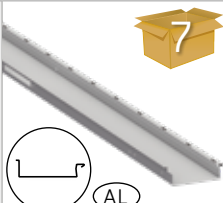
 <p>1A: 1x 2A: 1x 1B: 1x 2B: 1x</p> <p>ML</p>	 <p>1A: 1x 2A: 1x 1B: 1x 2B: 1x</p> <p>MR</p>	 <p>1A: 1x 2A: 1x 1B: 1x 2B: 1x</p> <p>AL</p>
---	--	--

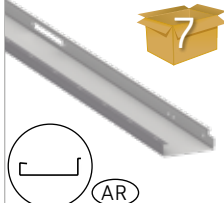

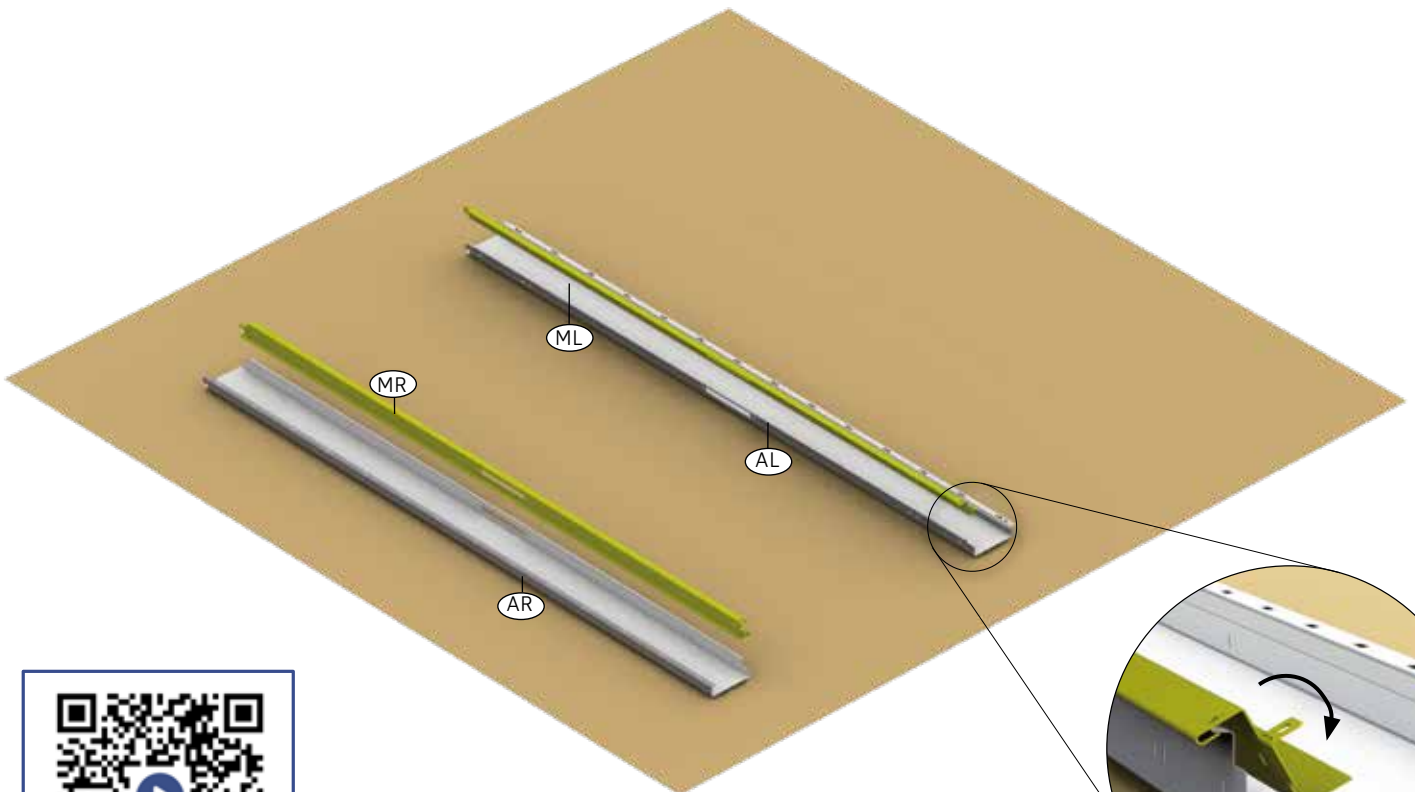
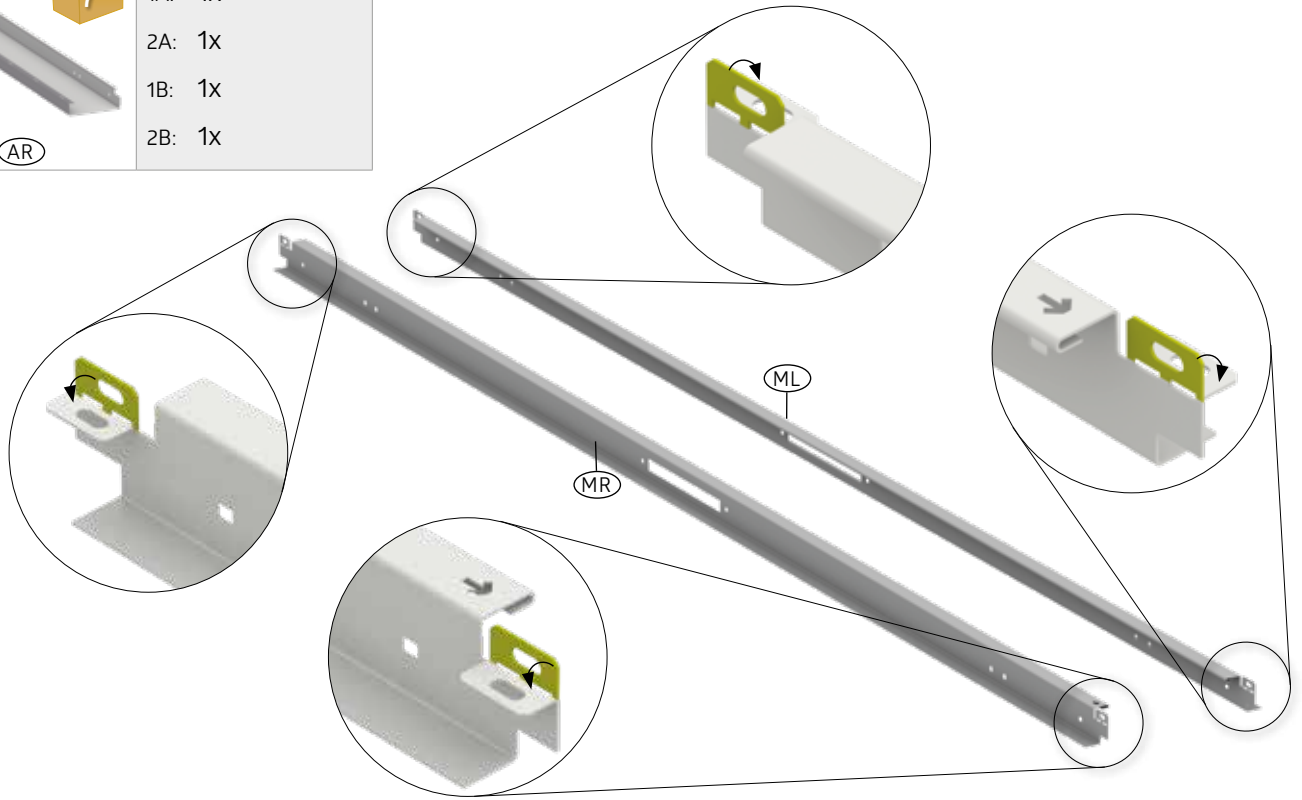

 <p>1A: 1x 2A: 1x 1B: 1x 2B: 1x</p> <p>AR</p>



8.

Standardtür - Vorderwand

Standard door-front wall - Porte standard-paroi frontale - Standaard deur-voorwand - Puerta estándar-pared frontal - Porta standard-parete anteriore - Standarddør-frontvæg - Standarddörr-framvægg - Standard dør-front vegg - Drzwi standardowe-ściana przednia - Štandardné dvere-predná stena - Standardna vrata-sprednja stena - Standardní dveře-přední stěna - Standard ajtó-elülső fal - Standardna vrata-prednji zid

M5 x 10		1A: 4X
		2A: 4X
		1B: 4X
		2B: 4X

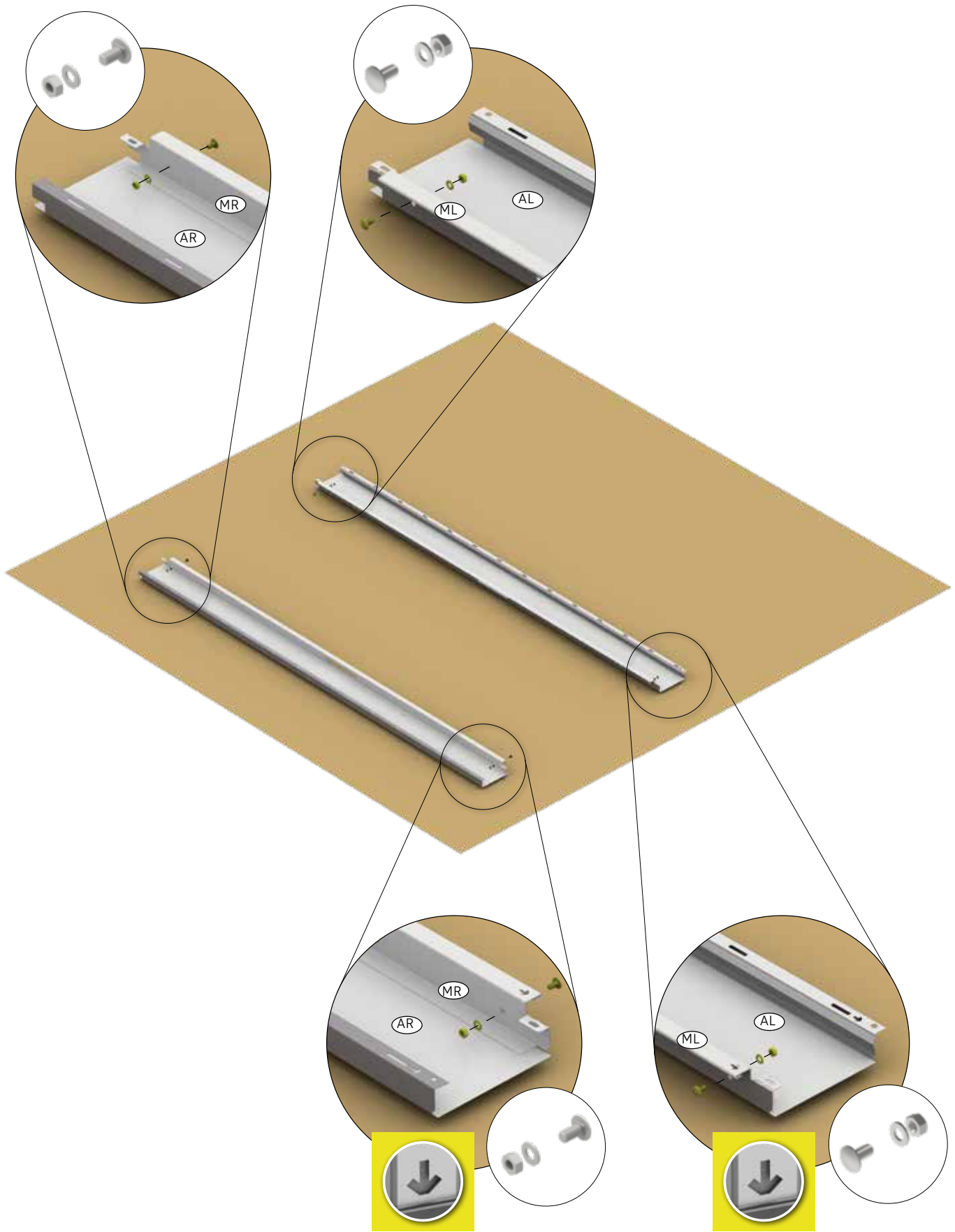

9.

Standardtür - Vorderwand

Standard door-front wall - Porte standard-paroi frontale - Standaard deur-voorwand - Puerta estándar-pared frontal - Porta standard-parete anteriore - Standarddør-frontvæg - Standarddörr-framvägg - Standard dør-front vegg - Drzwi standardowe-ściana przednia - Štandardné dvere-predná stena - Standardna vrata-sprednja stena - Standardní dveře-přední stěna - Standard ajtó-elülső fal - Standardna vrata-prednji zid

 <p>ⓐ</p>		1A: 1x	 <p>M5 x 10</p>  <p>ⓓ1</p>		1A: 1x
		2A: 1x			2A: 1x
		1B: 3x			1B: 3x
		2B: 3x			2B: 3x

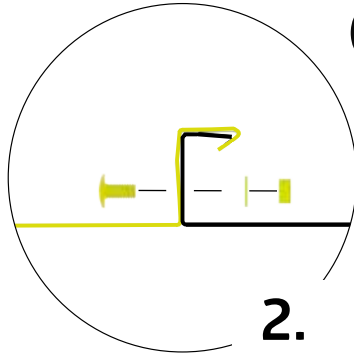
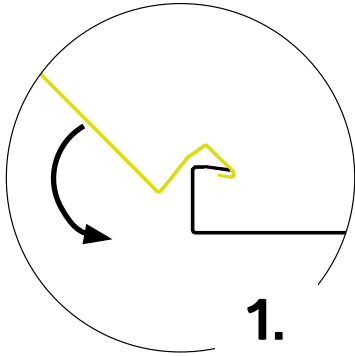

FESTZIEHEN



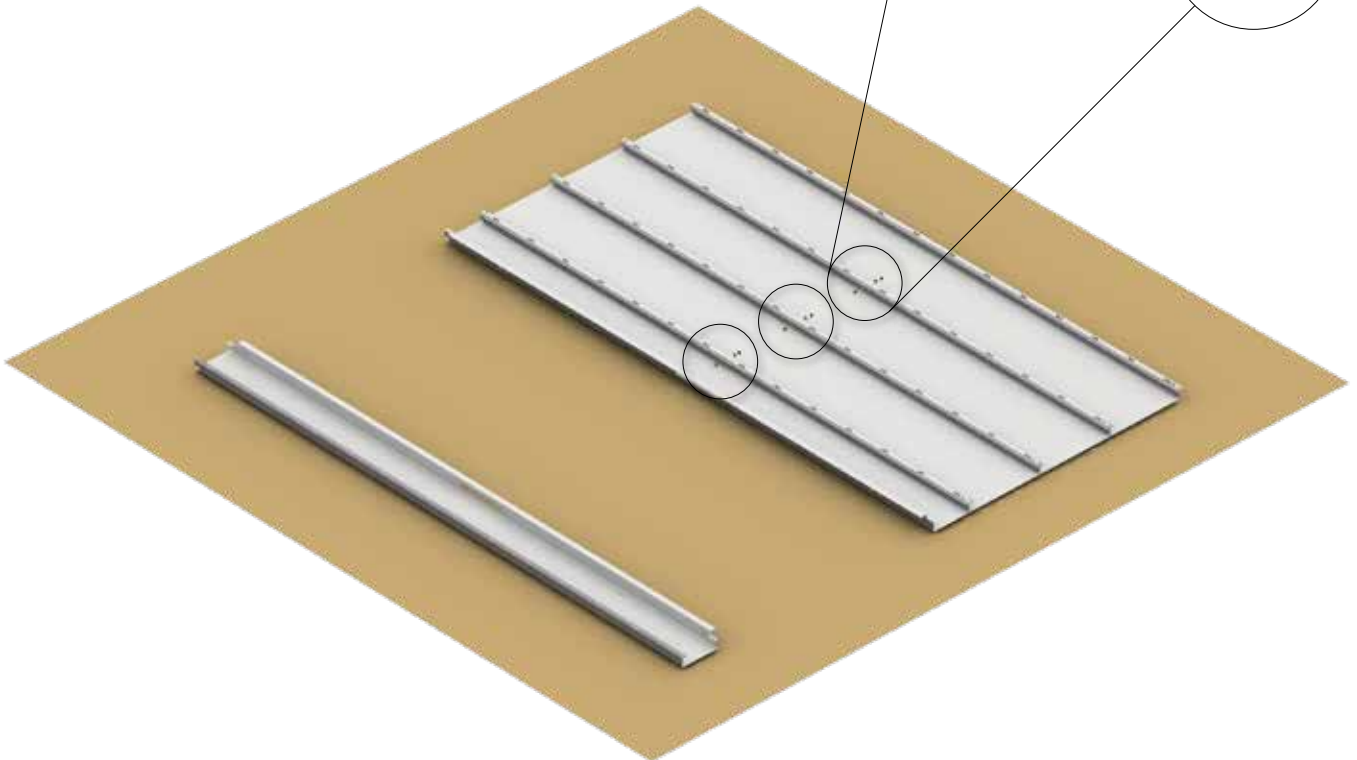
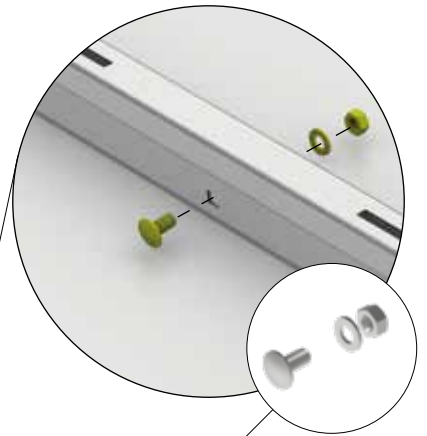



- ⒸB tighten
- ⒻR serrez fort
- ⒸL vastdraaien
- ⒺS apriete
- ⒸT serrare a fondo
- ⒸK fastspænding
- ⒺE Dra åt
- ⒸO Stramme
- ⒸL Dokrećić
- ⒺK Dotiahnuť
- ⒺI Zategnite
- ⒸZ Dotáhnout
- ⒺU Erősen meghúzni
- ⒺR Zategnite

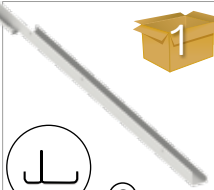

10.

Standardtür - Vorderwand

Standard door-front wall - Porte standard-paroi frontale - Standaard deur-voorwand - Puerta estándar-pared frontal - Porta standard-parete anteriore - Standarddør-frontvæg - Standarddörr-framvägg - Standard dør-front vegg - Drzwi standardowe-ściana przednia - Štandardné dvere-predná stena - Standardna vrata-sprednja stena - Standardní dveře-přední stěna - Standard ajtó-elülső fal - Standardna vrata-prednji zid

 	 <p>1A: 1x 2A: 1x 1B: 1x 2B: 1x</p>	 	 <p>1A: 1x 2A: 1x 1B: 1x 2B: 1x</p>	<p>M5 x 10</p>  	<p>1A: 3x 2A: 3x 1B: 3x 2B: 3x</p>
---	--	---	--	--	--

1.

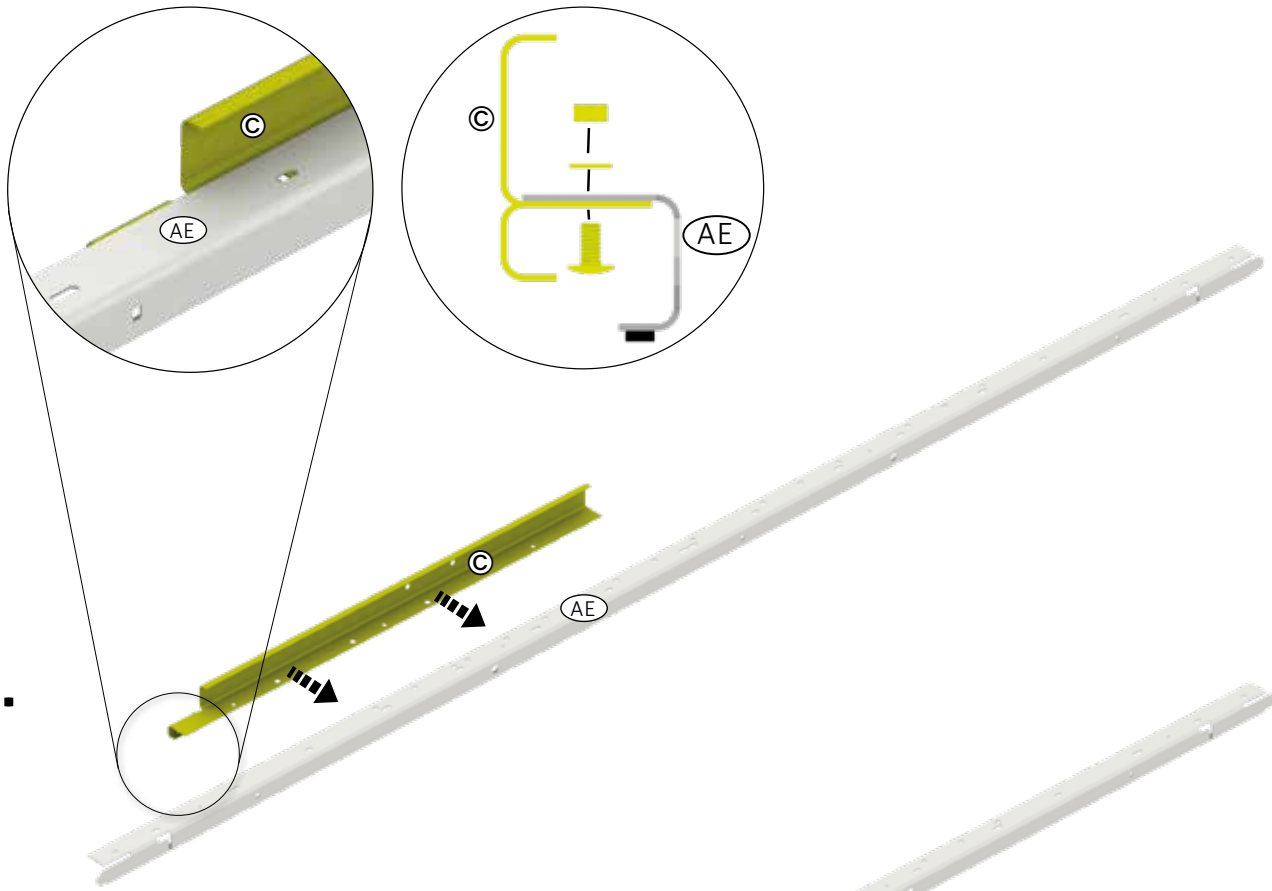



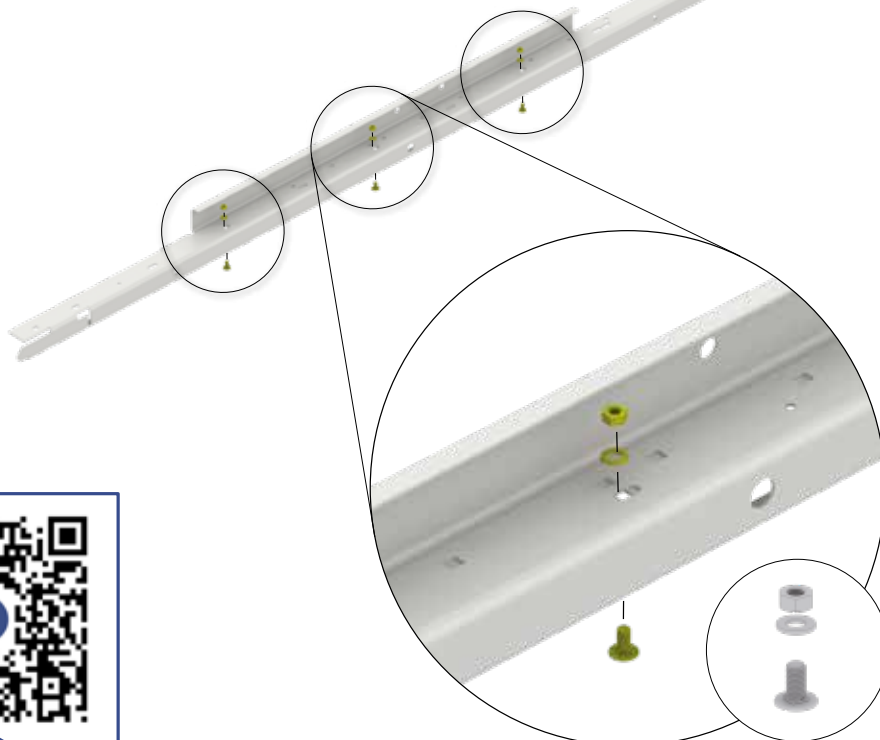

2.



11.

Standardtür - Vorderwand







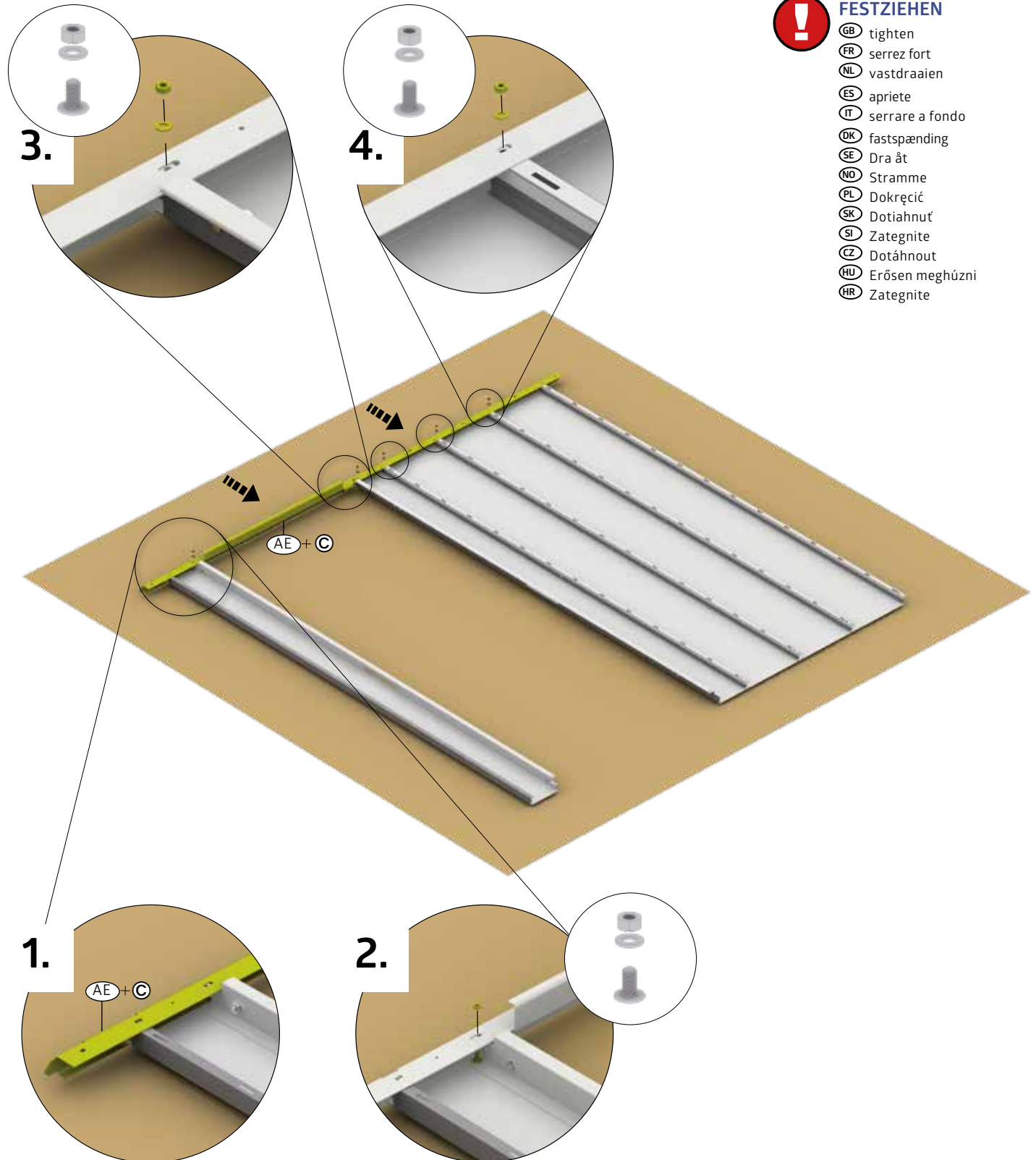







Standard door-front wall - Porte standard-paroi frontale - Standaard deur-voorwand - Puerta estándar-pared frontal - Porta standard-parete anteriore - Standarddør-frontvæg - Standarddörr-framvägg - Standard dør-front vegg - Drzwi standardowe-ściana przednia - Štandardné dvere-predná stena - Standardna vrata-sprednja stena - Standardní dveře-přední stěna - Standard ajtó-elülső fal - Standardna vrata-prednji zid

M5 x 10		1A: 3X
		2A: 3X
		1B: 5X
		2B: 5X

(D1)





FESTZIEHEN

-  tighten
-  serrez fort
-  vastdraaien
-  apriete
-  serrare a fondo
-  fastspænding
-  Dra åt
-  Stramme
-  Dokręcić
-  Dotiahnuť
-  Zategnite
-  Dotáhnout
-  Erősen meghúzni
-  Zategnite

12.



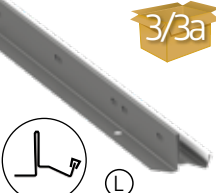











Standardtør - Vorderwand

Standard door-front wall - Porte standard-paroi frontale - Standaard deur-voorwand - Puerta estándar-pared frontal - Porta standard-parete anteriore - Standarddør-frontvæg - Standarddörr-framvägg - Standard dør-front vegg - Drzwi standardowe-ściana przednia - Štandardné dvere-predná stena - Standardna vrata-sprednja stena - Standardní dveře-přední stěna - Standard ajtó-elülső fal - Standardna vrata-prednji zid

	1A: 1X		1A: 3X
	2A: 1X		2A: 3X
	1B: 1X		1B: 5X
	2B: 1X		2B: 5X



FESTZIEHEN

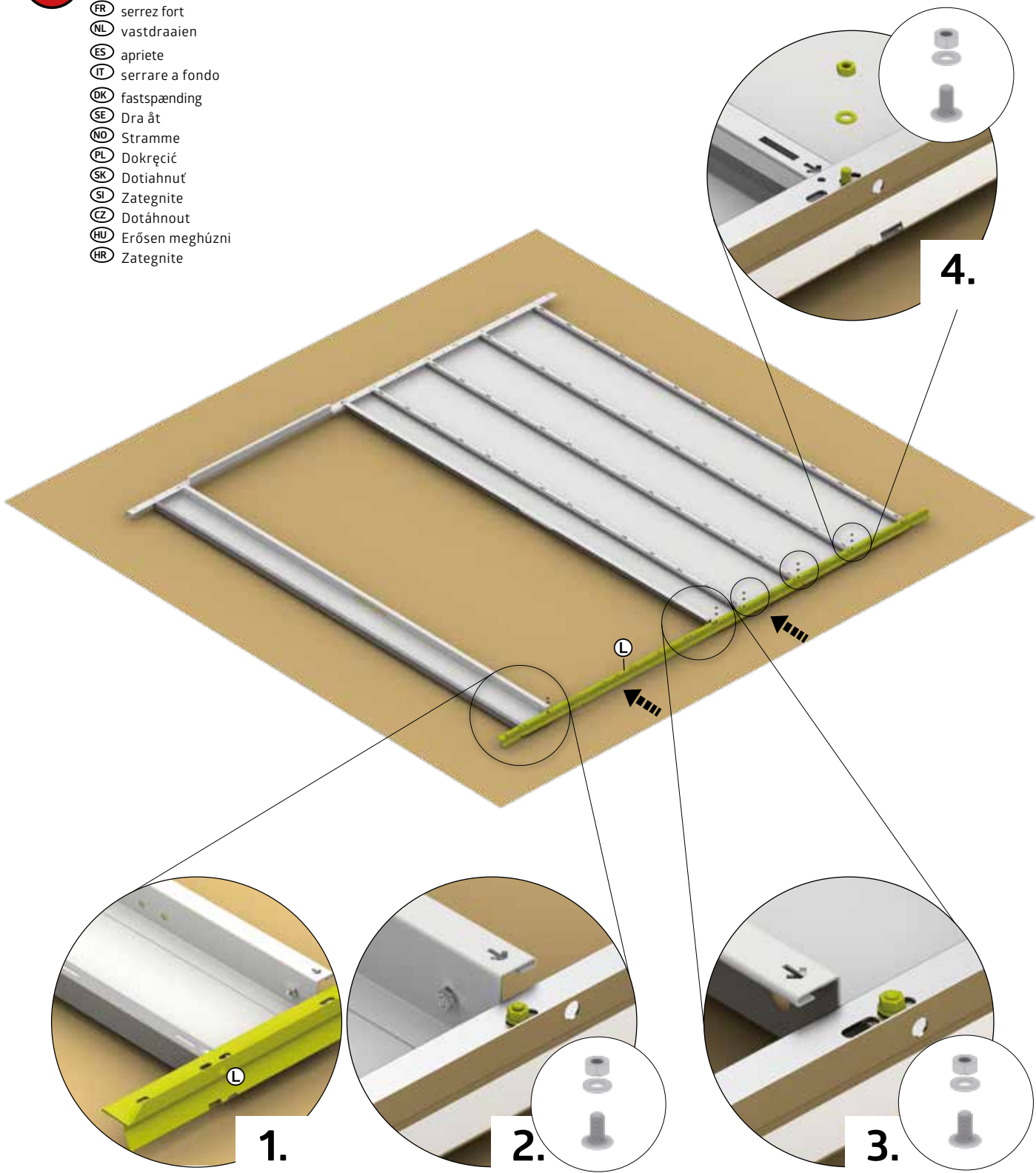

-  tighten
-  serrez fort
-  vastdraaien
-  apriete
-  serrare a fondo
-  fastspænding
-  Dra åt
-  Stramme
-  Dokręcić
-  Dotiahnuť
-  Zategnite
-  Dotáhnout
-  Erősen meghúzni
-  Zategnite





Bodenrahmen

Floor frame - Cadre de sol - Bodemframe - Marco de suelo - Telaio perimetrale - Bundramme - Bottenram - Gulvramme - Rama podłogowa - Podlahový rám - Podlahový rám - Talni okvir · Padlókeret - Podni okvir



 <p>(ZB)</p>	1A: 4X (1580 mm)	 <p>(ZC)</p>	1A: 4X
	2A: 2X (1580 mm) 2X (2140 mm)		2A: 4X
	1B: 2X (2140 mm) 2X (1580 mm)		1B: 4X
	2B: 4X (2140 mm)		2B: 4X

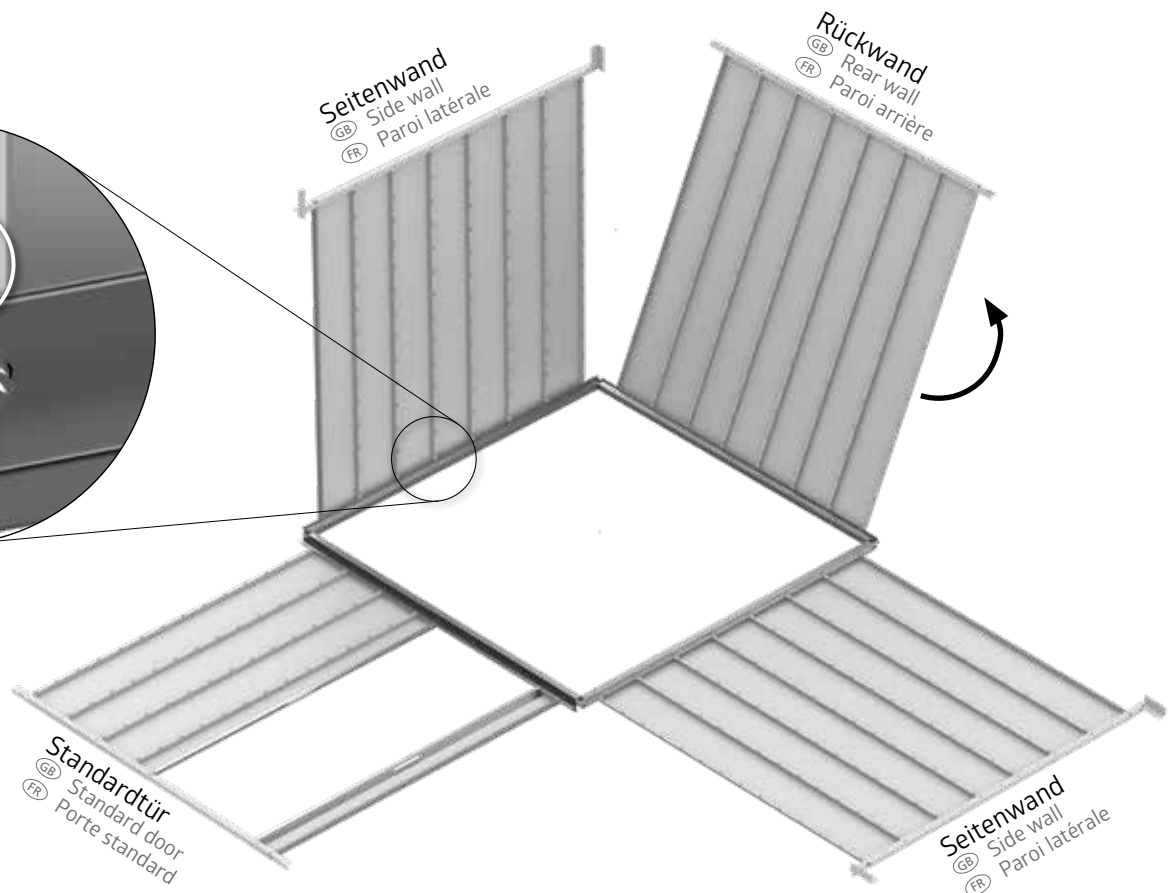
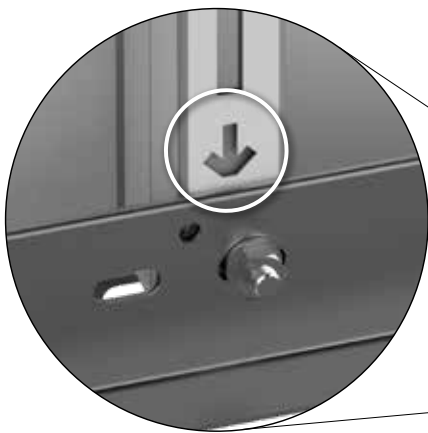
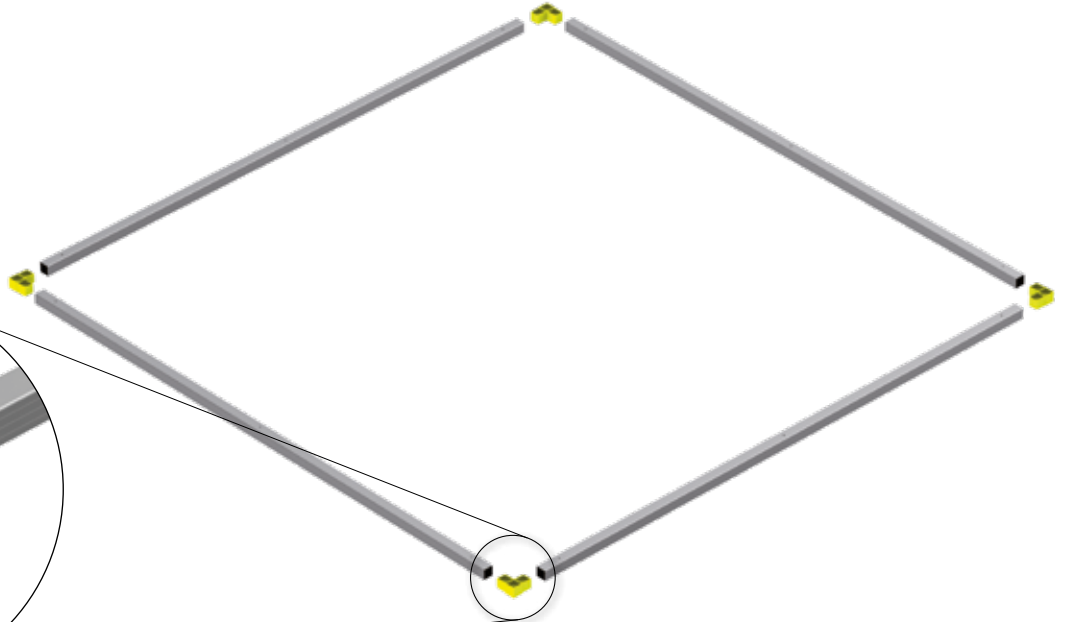
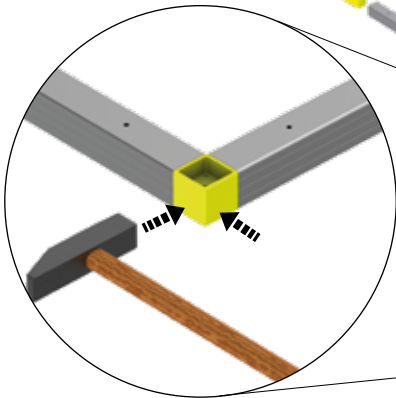

Lochseite oben

- (GB) Hole side up
- (FR) Trou côté supérieur



 (ZD)	1A: 7x 2A: 7x 1B: 7x 2B: 7x	6.3 x 22  (ZF)	1A: 11x 2A: 11x 1B: 11x 2B: 11x	 (LB)	1A: 4x 2A: 4x 1B: 4x 2B: 4x
--	--------------------------------------	---	--	--	--------------------------------------

M5 x 10  (D1)	1A: 12x 2A: 12x 1B: 12x 2B: 12x
--	--

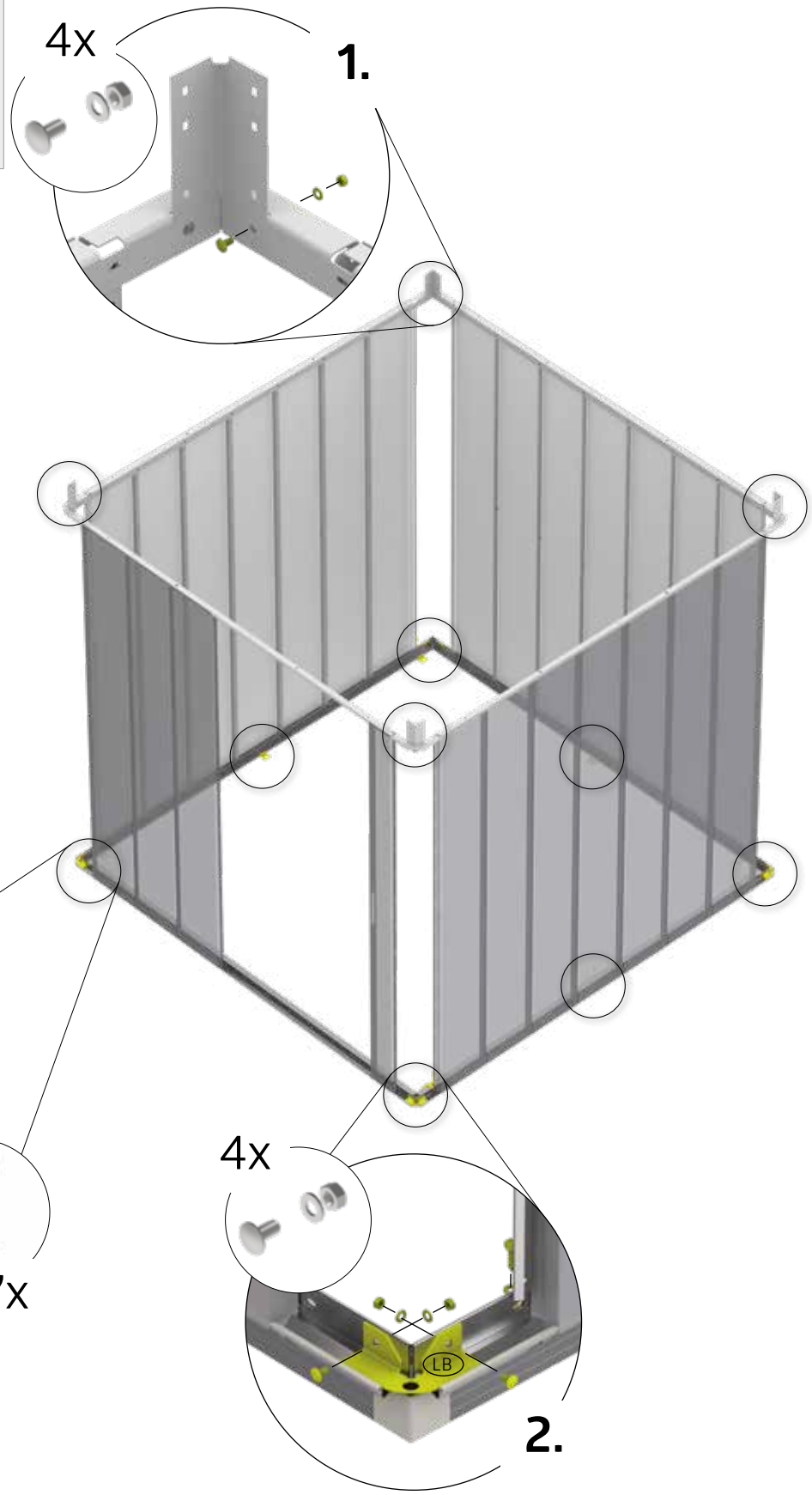

13.



7

- 1A: 4x
- 2A: 4x
- 1B: 4x
- 2B: 4x

M5 x 10



7

- 1A: 12x
- 2A: 12x
- 1B: 12x
- 2B: 12x

Seitenwand
Side wall
Paroi latérale

Rückwand
Rear wall
Paroi arrière

Standardtür
Standard door
Porte standard

Seitenwand
Side wall
Paroi latérale

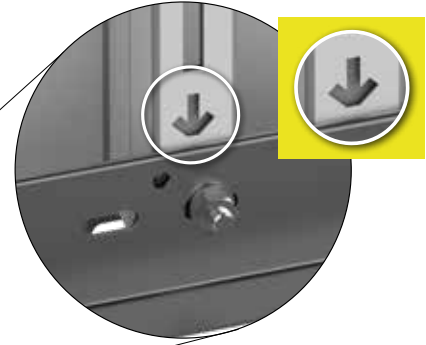

4x

1.

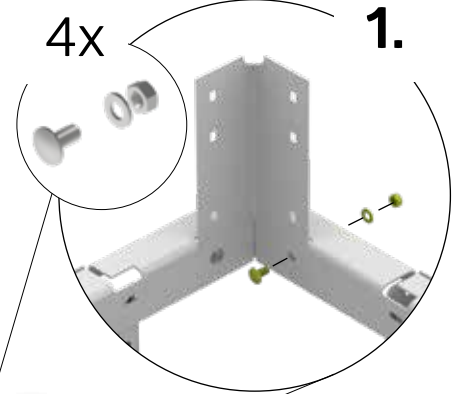

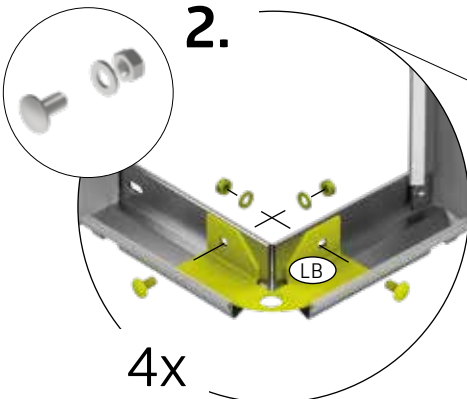

2.

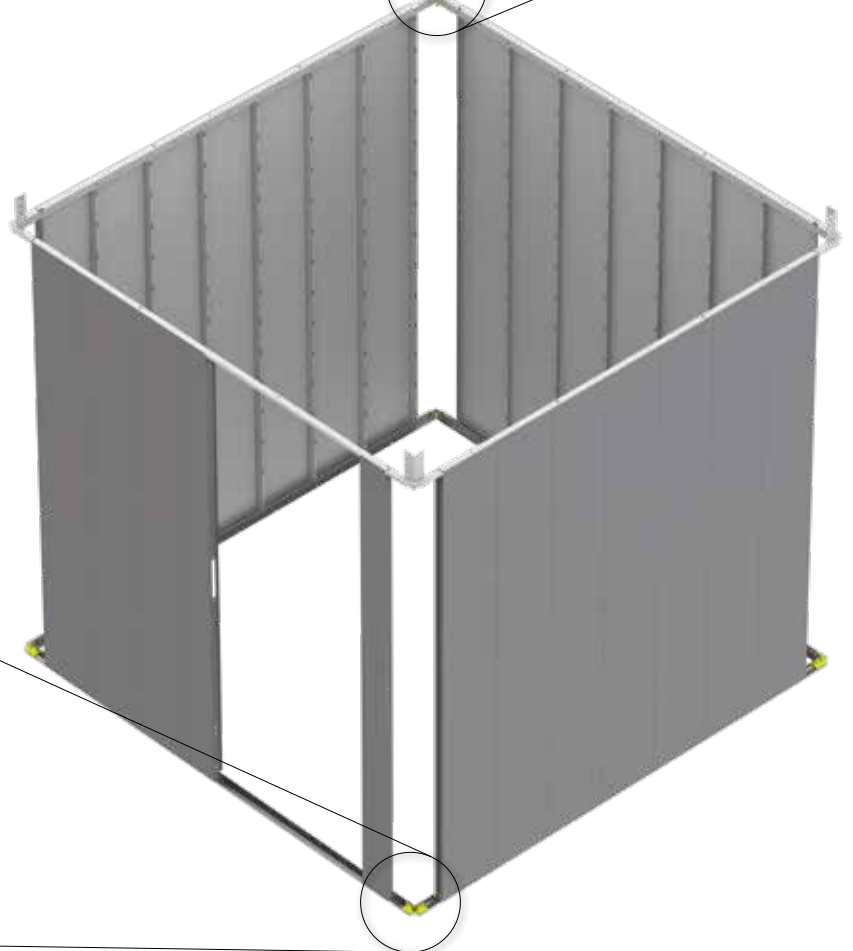

4x

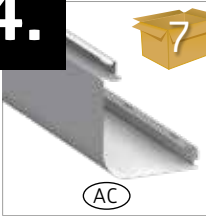

14.

 AC	 1A: 4x 2A: 4x 1B: 4x 2B: 4x	M5 x 10	 D1	1A: 8x 2A: 8x 1B: 8x 2B: 8x
---	--	---------	--	--------------------------------------

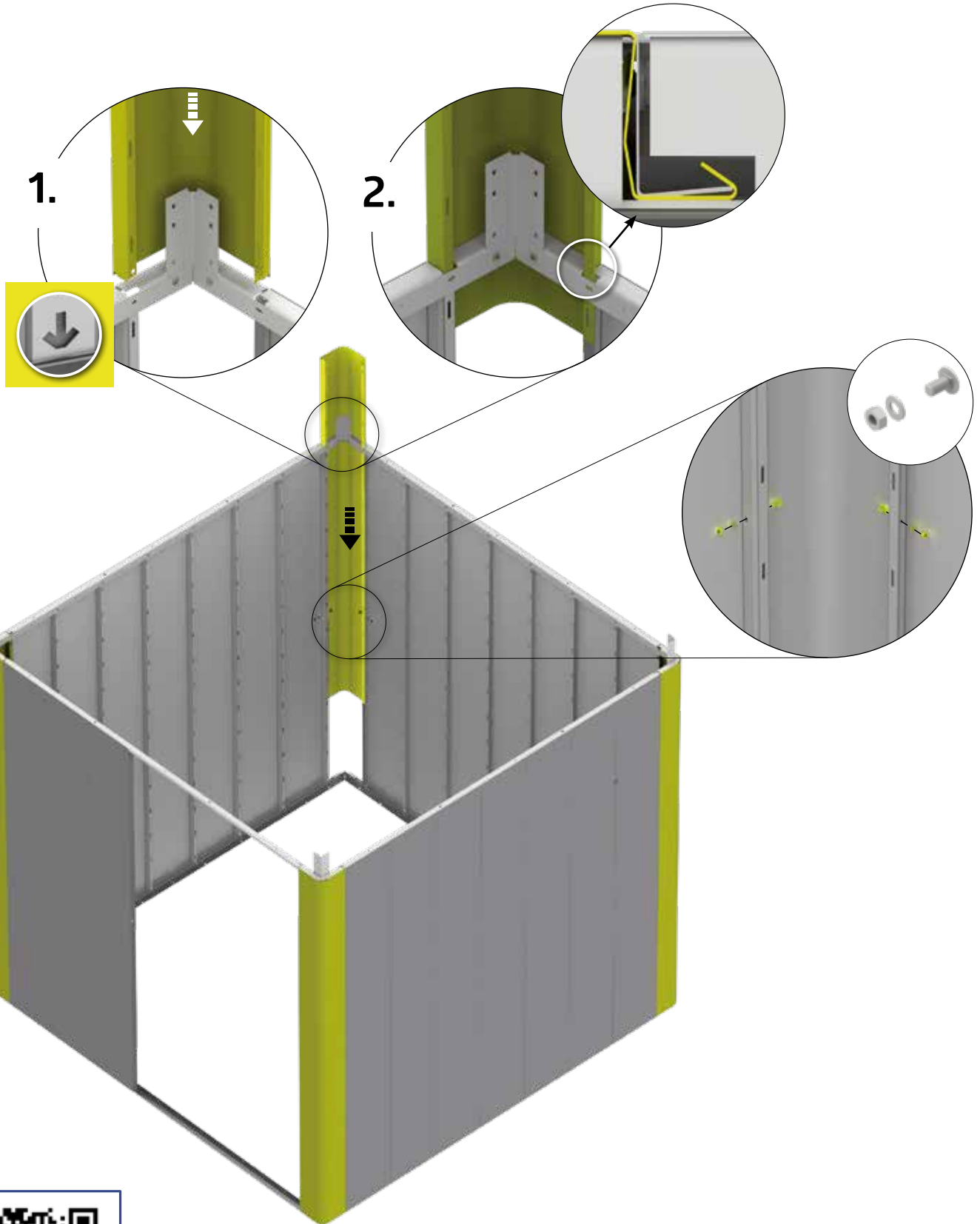

15.

M5 x 10



- 1A: 16x
- 2A: 16x
- 1B: 16x
- 2B: 16x

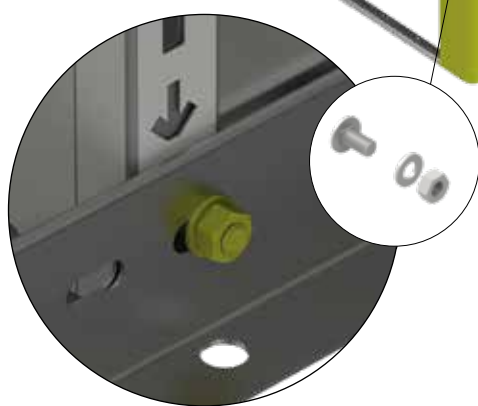
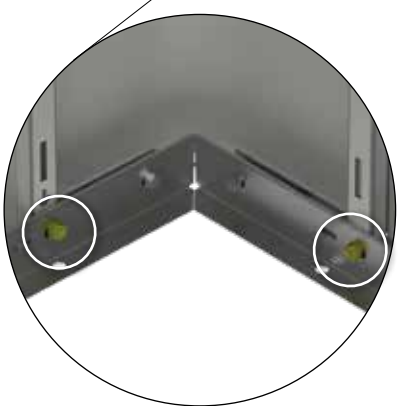
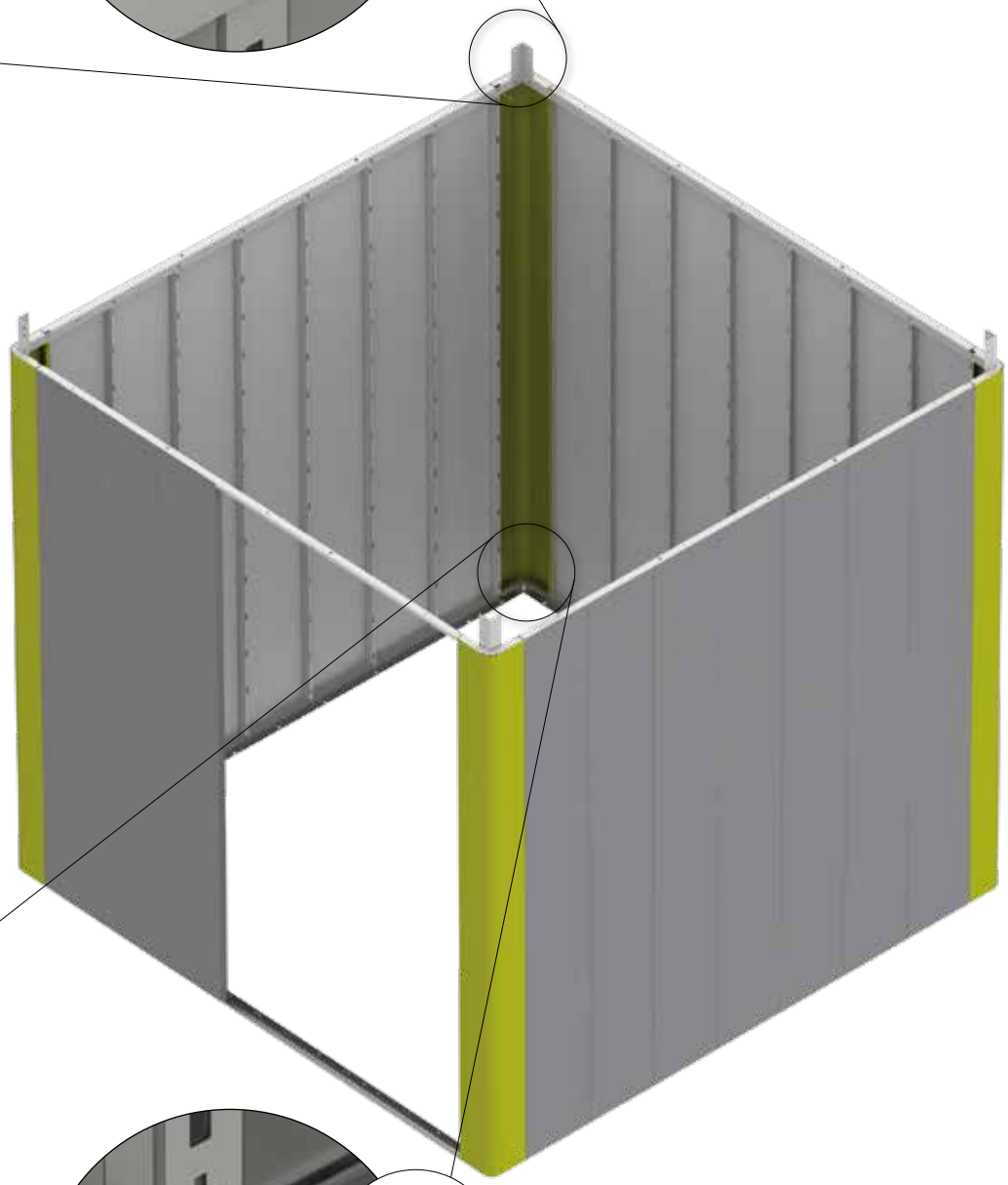
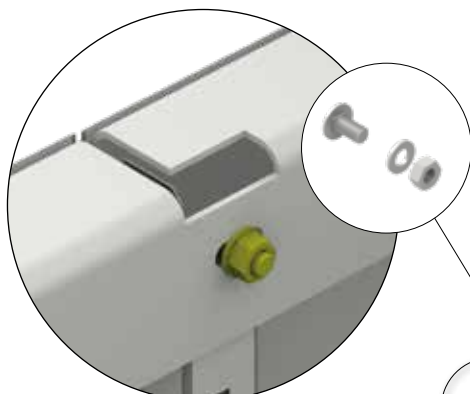
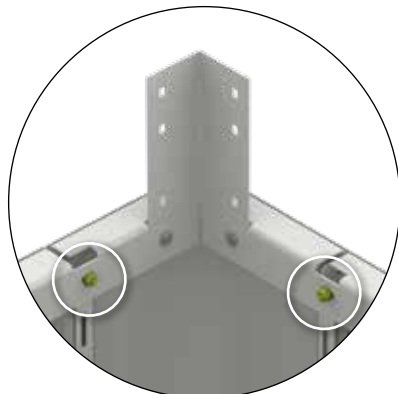

16.

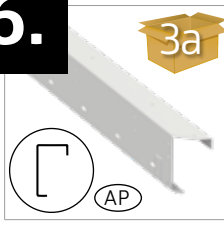
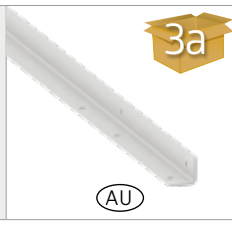
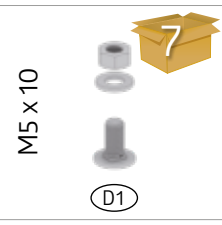
 <p>3a AP</p>	<p>1A: 1X (1717 mm) 2A: 1X (1717 mm) 1B: 1X (2277 mm) 2B: 1X (2277 mm)</p>	 <p>3a AU</p>	<p>1A: 1X (1619 mm) 2A: 1X (1619 mm) 1B: 1X (2179 mm) 2B: 1X (2179 mm)</p>	<p>M5 x 10</p>  <p>7 D1</p>	<p>1A: 9x 2A: 9x 1B: 11x 2B: 11x</p>
--	--	---	--	---	--

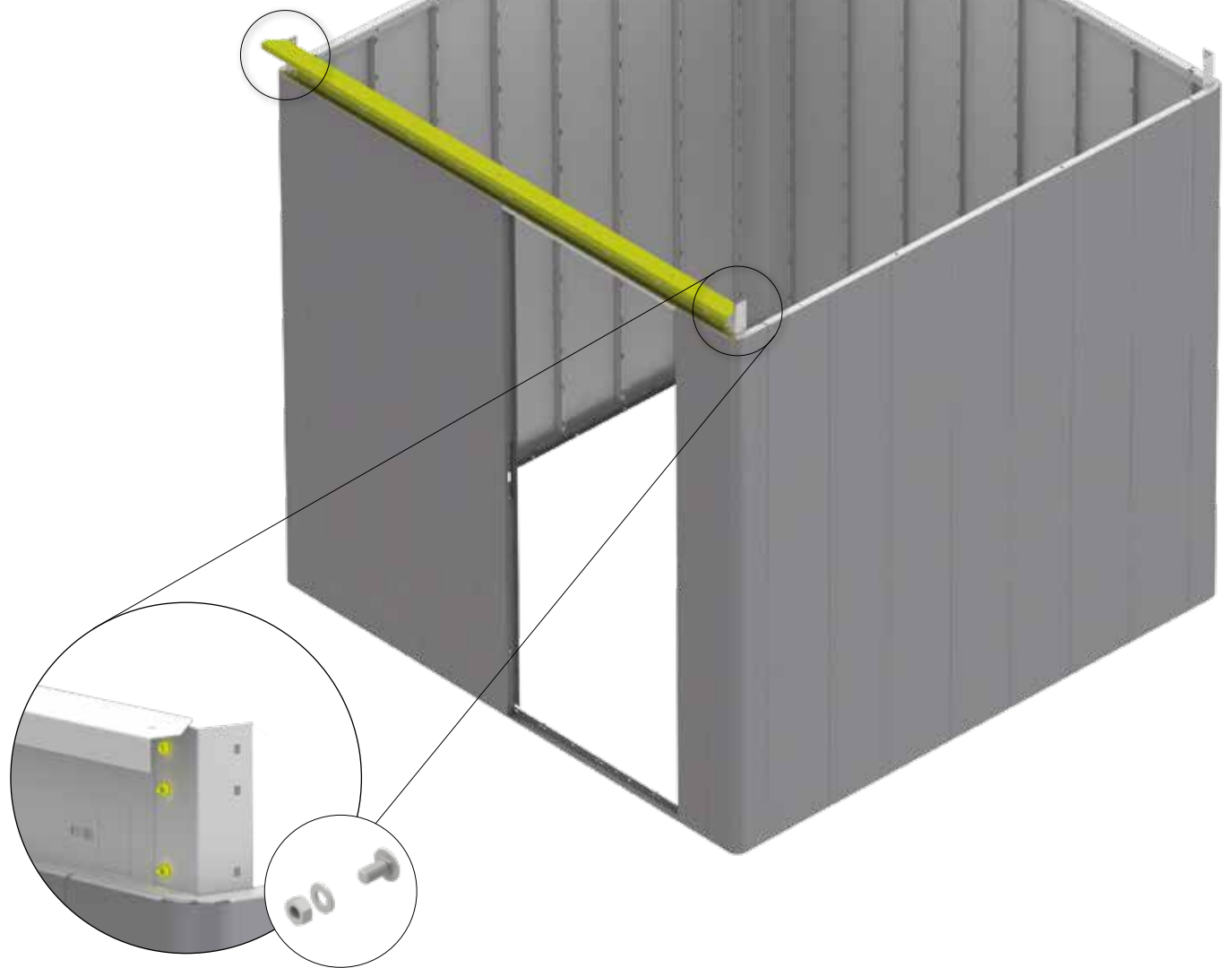
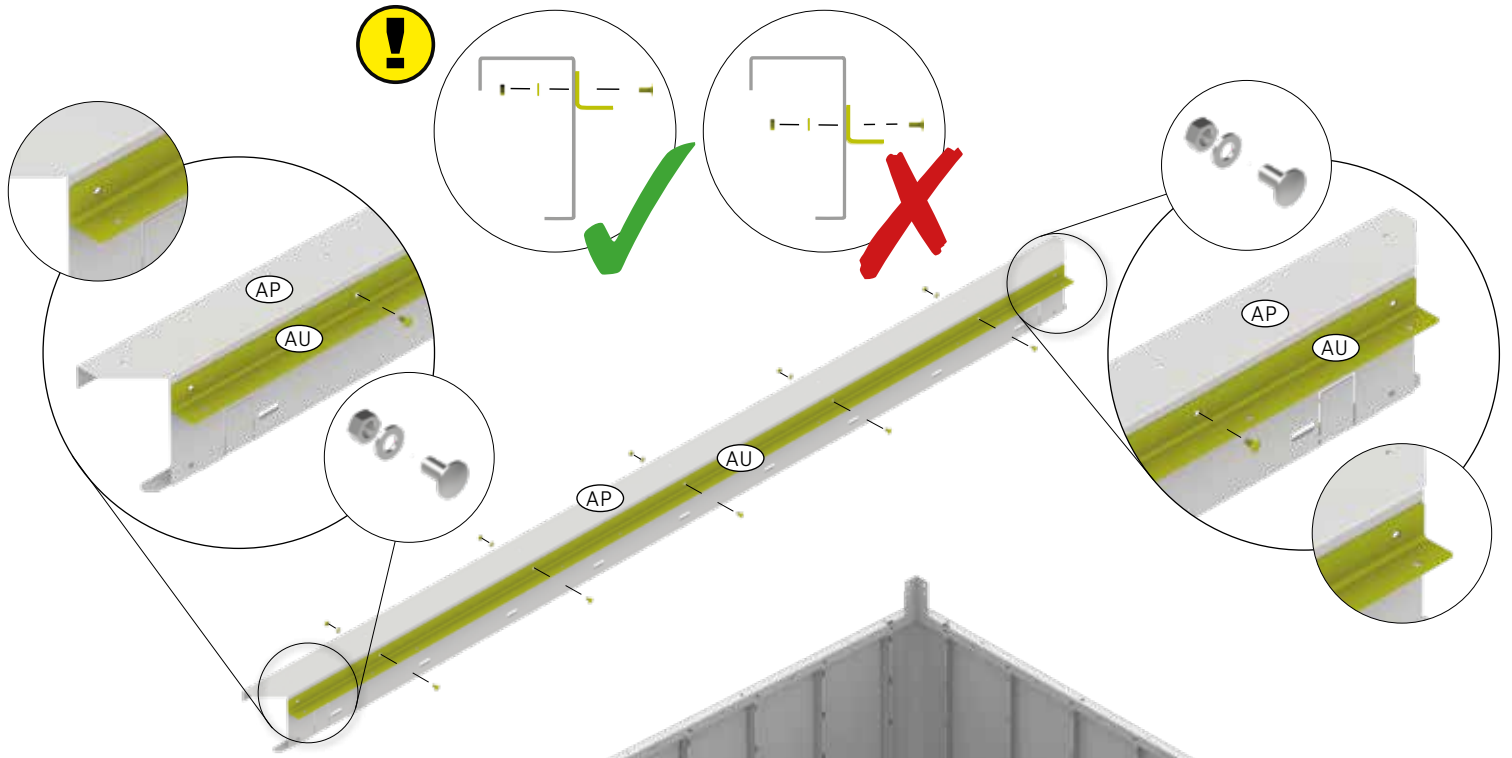



17.

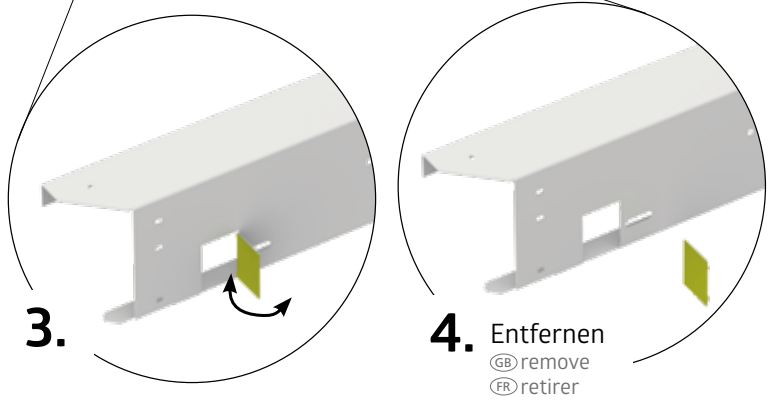
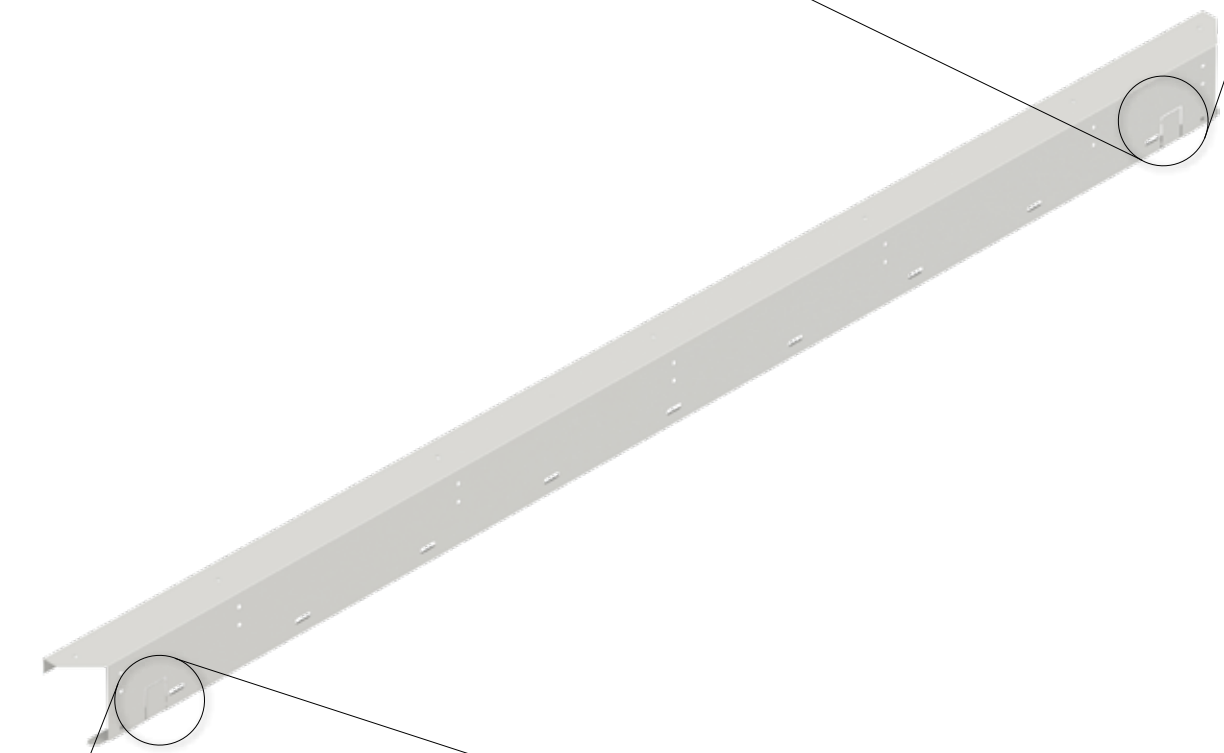
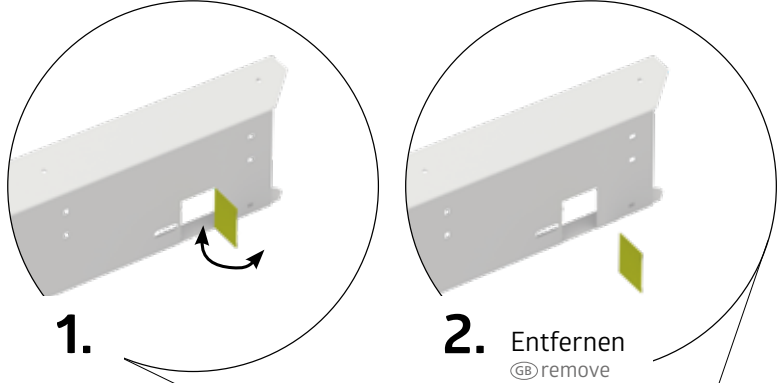

3a

1A:	1X (1717 mm)
2A:	1X (1717 mm)
1B:	1X (2277 mm)
2B:	1X (2277 mm)

AP







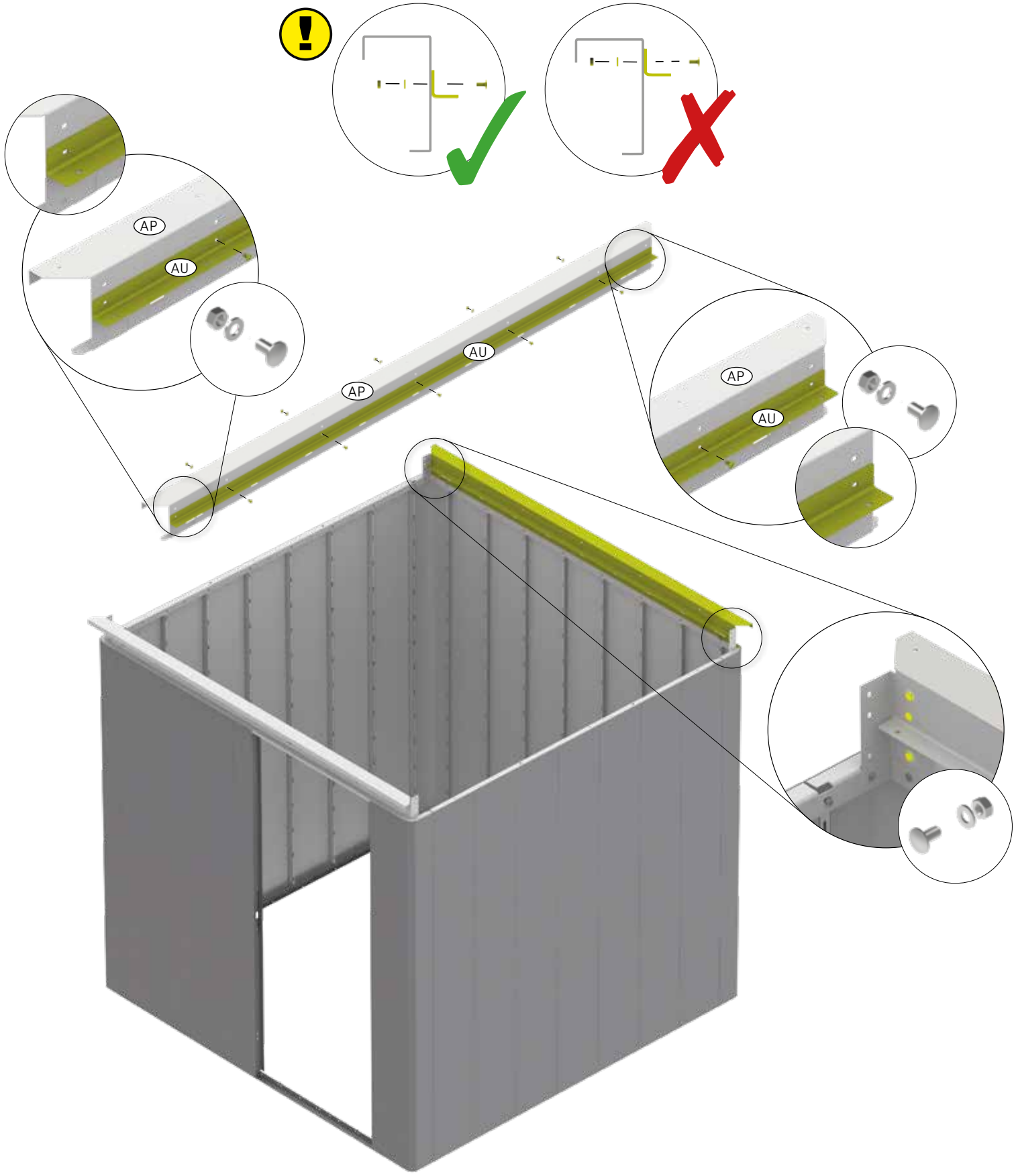

18.

 3a (AU)	1A: 1X (1619 mm)	 7 M5x10 (D1)	1A: 9X
	2A: 1X (1619 mm)		2A: 9X
	1B: 1X (2179mm)		1B: 11x
	2B: 1X (2179 mm)		2B: 11x



19.

 BP	 3 1A: 1X (1717 mm) 2A: 1X (2277 mm) 1B: 1X (1717 mm) 2B: 1X (2277 mm)	 BU	 3 1A: 1X (1553 mm) 2A: 1X (2113 mm) 1B: 1X (1553 mm) 2B: 1X (2113 mm)	M5 x 10  D1	 7 1A: 9x 2A: 11x 1B: 9x 2B: 11x
---	--	--	--	--	--





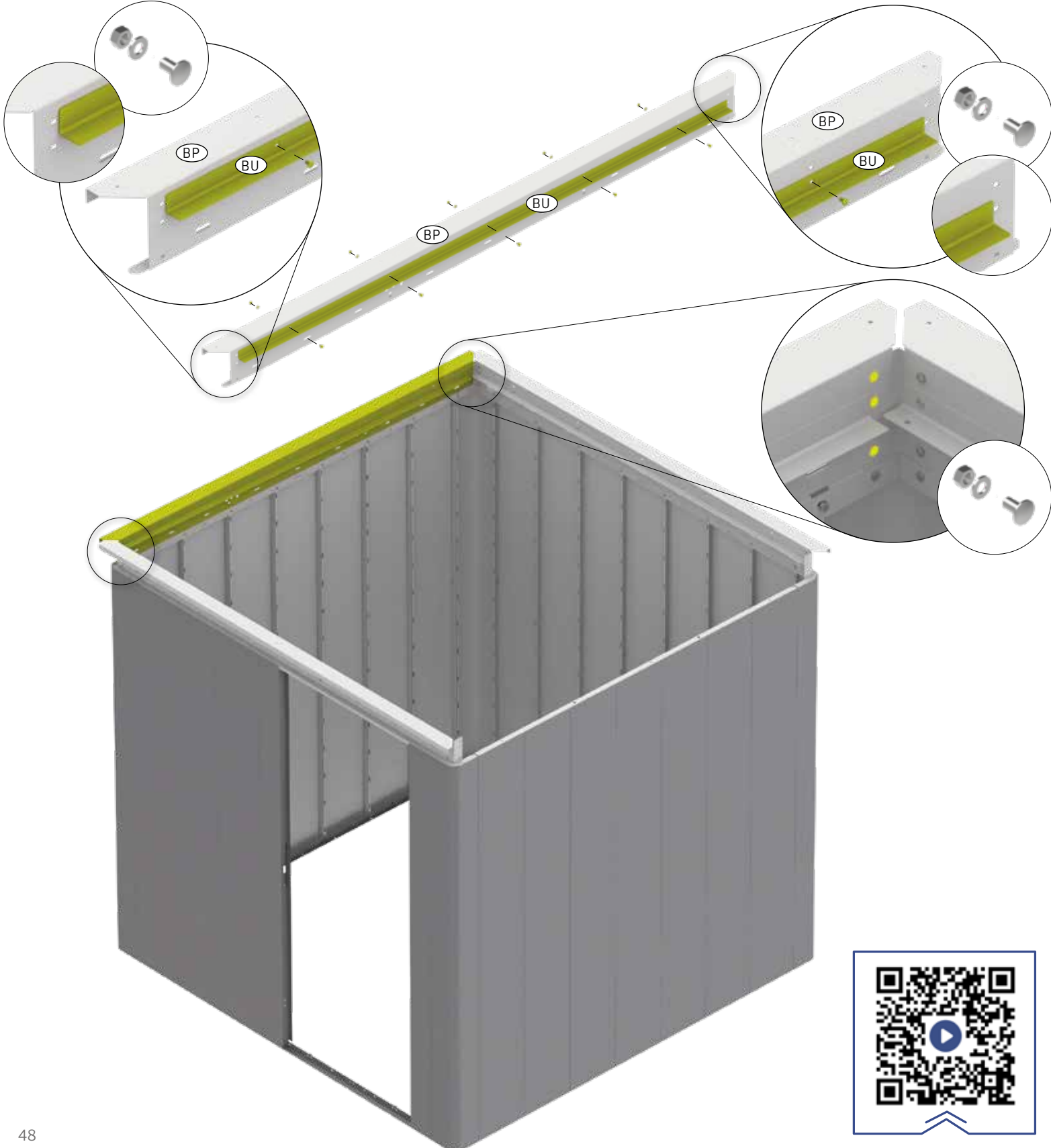
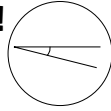

Achten Sie auf das Gefälle!

 Pay attention to the slope!

 Attention aux pentes!

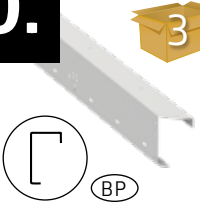

20.

 BP	 1A: 1X (1717 mm) 2A: 1X (2277 mm) 1B: 1X (1717 mm) 2B: 1X (2277 mm)	 BU	 1A: 1X (1553 mm) 2A: 1X (2113 mm) 1B: 1X (1553 mm) 2B: 1X (2113 mm)	M5 x 10	 D1	1A: 9X 2A: 11X 1B: 9X 2B: 11X
--	--	--	--	---------	--	--



Achten Sie auf das Gefälle!

GB Pay attention to the slope!
FR Attention aux pentes!

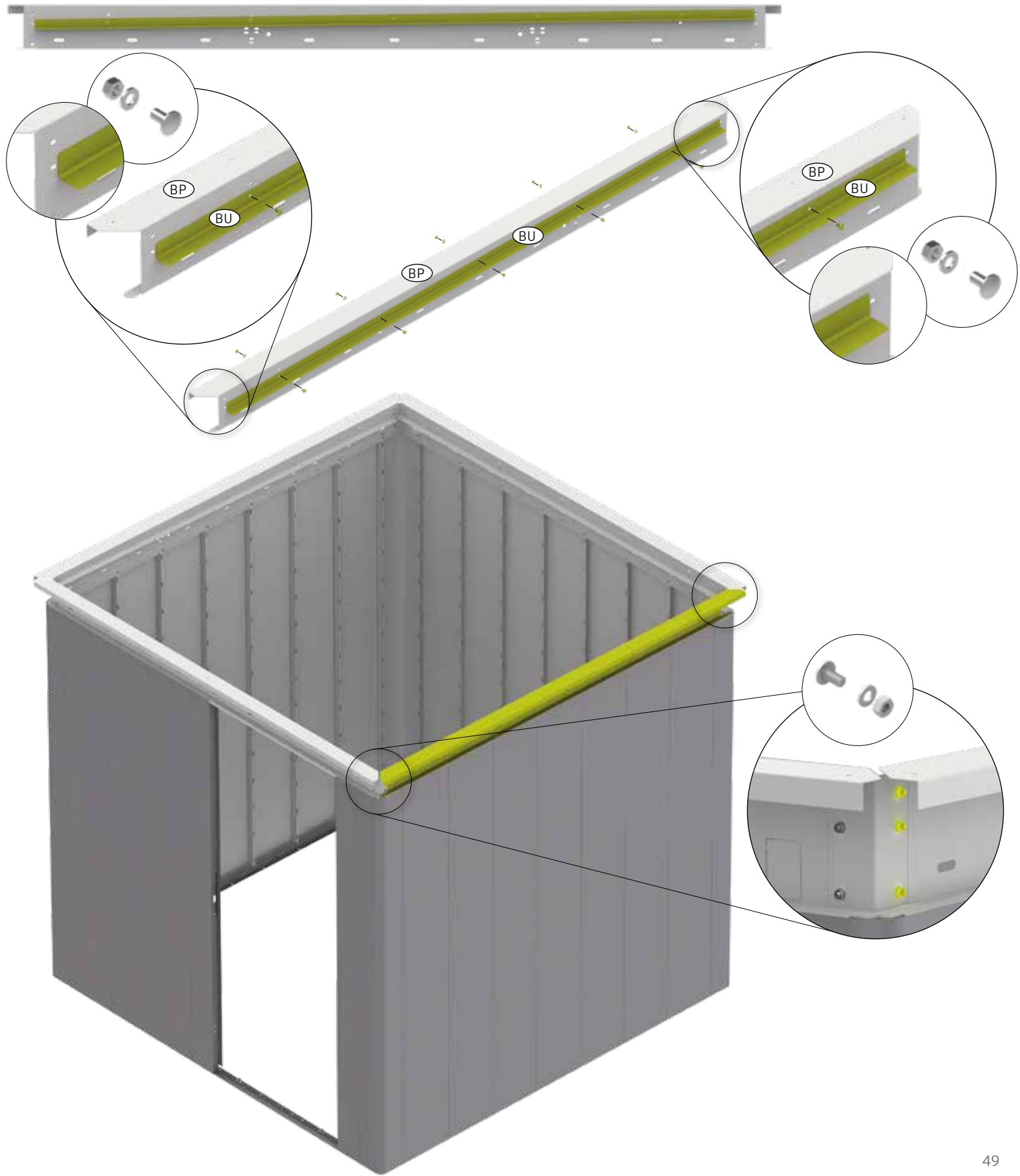
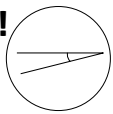

21.

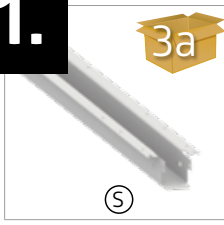
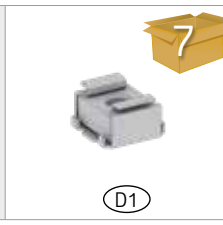
	3a	1A: 2X (1690 mm)
		2A: 2X (1690 mm)
		1B: 2X (2250 mm)
		2B: 2X (2250 mm)
	7	1A: 12X
		2A: 12X
		1B: 12X
		2B: 12X

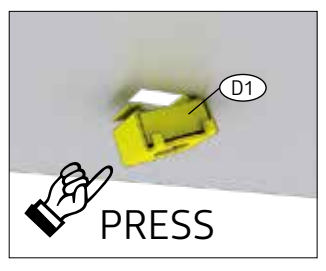
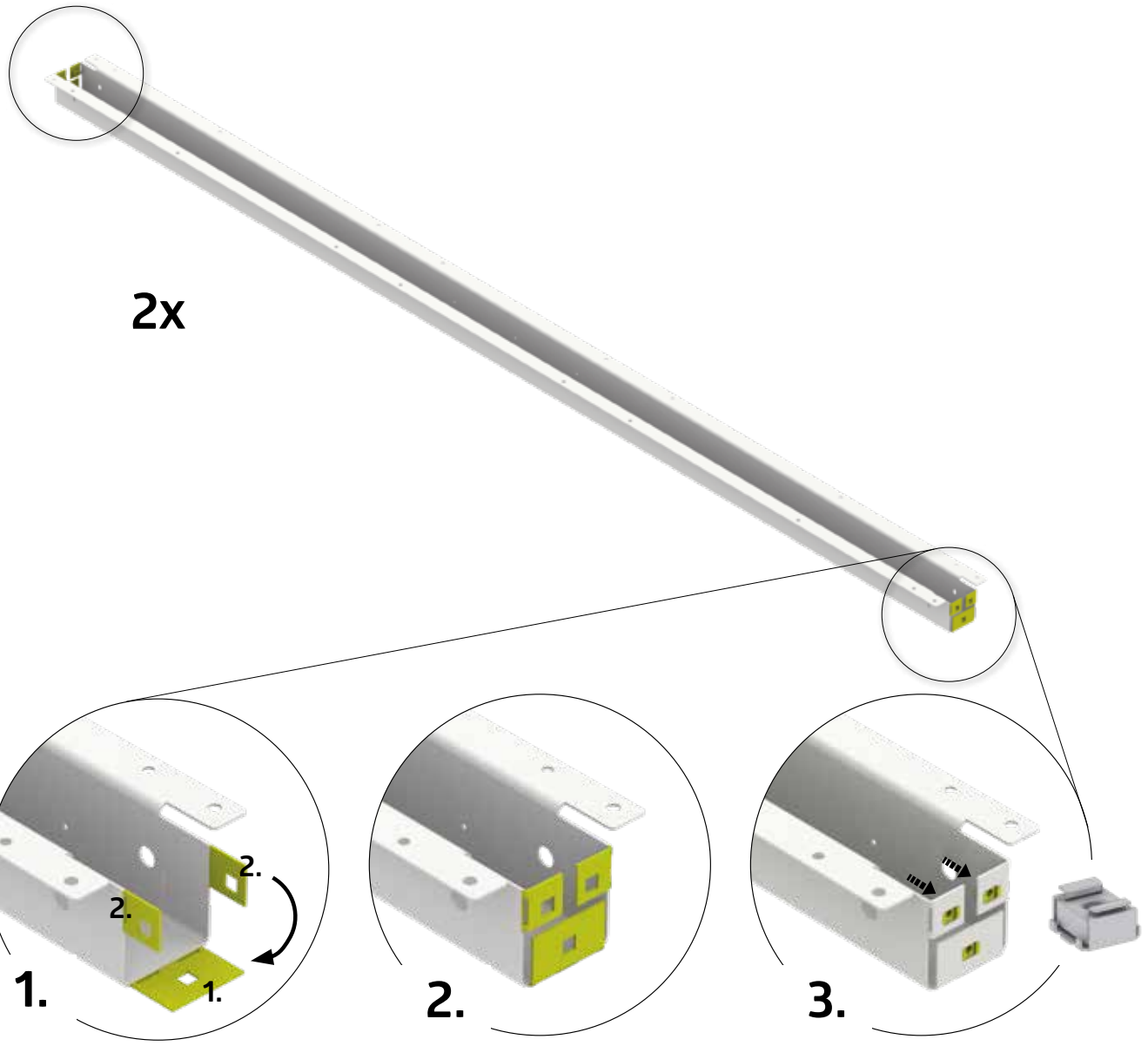

22.



7

1A: 12x

2A: 12x

1B: 12x

2B: 12x

M5 x 16

D1

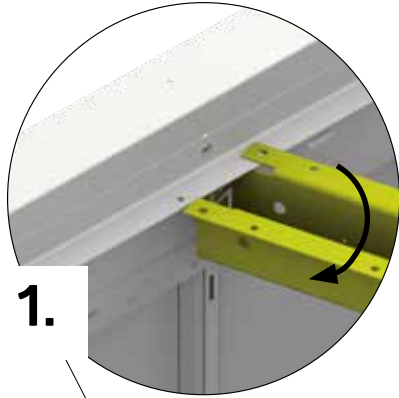



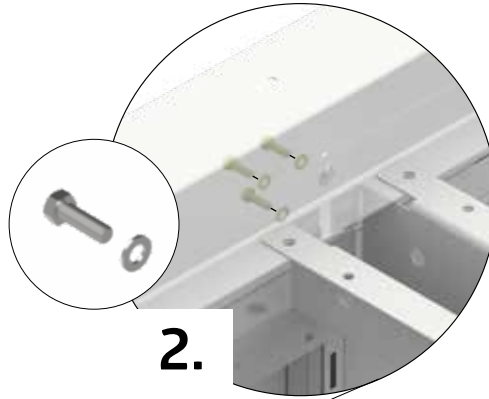



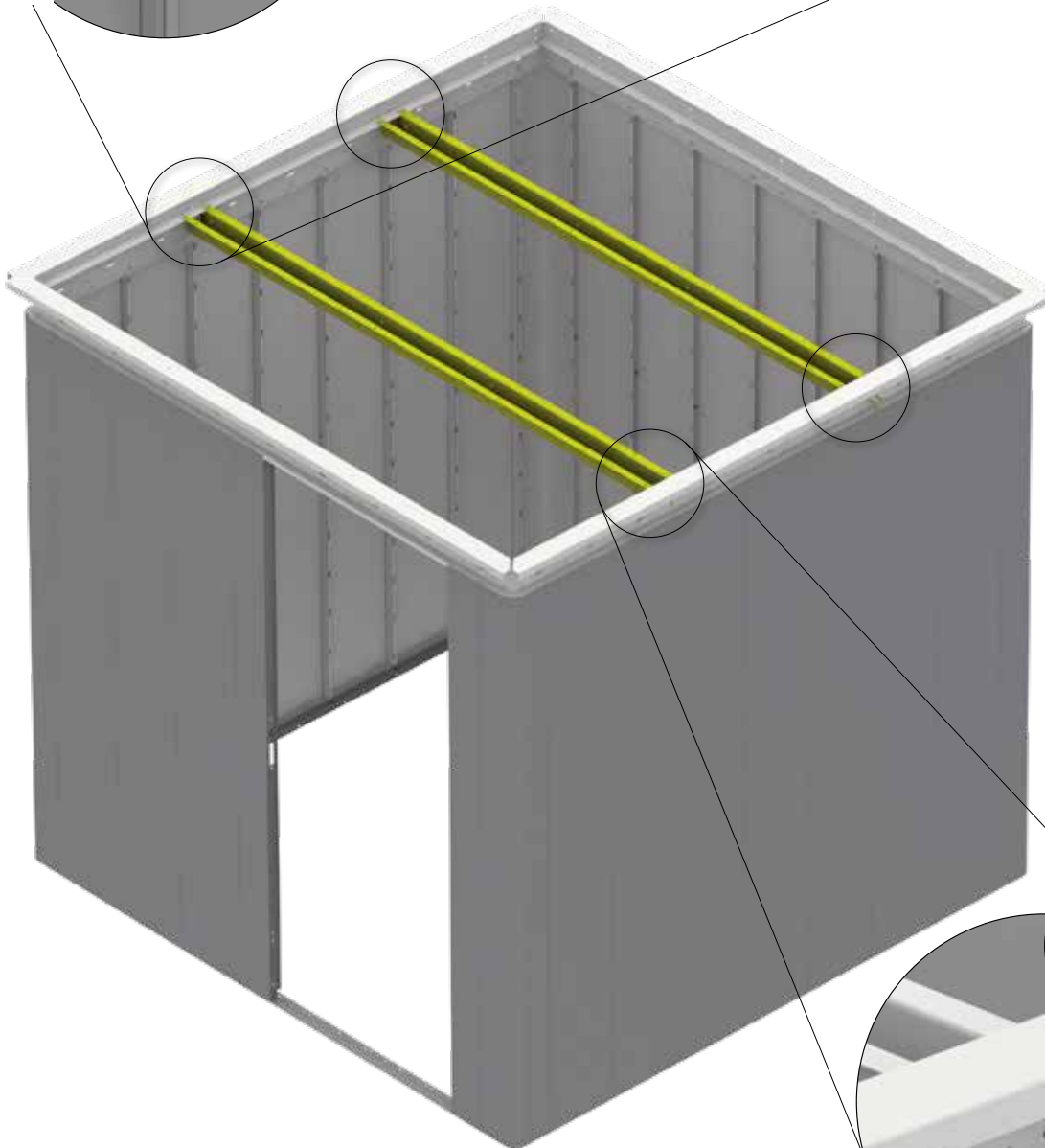

1.



2.



23.

 (RA)	 1A: 2X 2A: 2X 1B: 2X 2B: 2X	4,8 x 13  (D2)	 1A: 6X 2A: 6X 1B: 6X 2B: 6X	 (W)	 1A: 1X (1624 mm) 2A: 1X (2184 mm) 1B: 1X (1624 mm) 2B: 1X (2184 mm)
 (Y)	 1A: 1X (1624 mm) 2A: 1X (2184 mm) 1B: 1X (1624 mm) 2B: 1X (2184 mm)	 (D2)	 1A: 2X 2A: 2X 1B: 2X 2B: 2X		

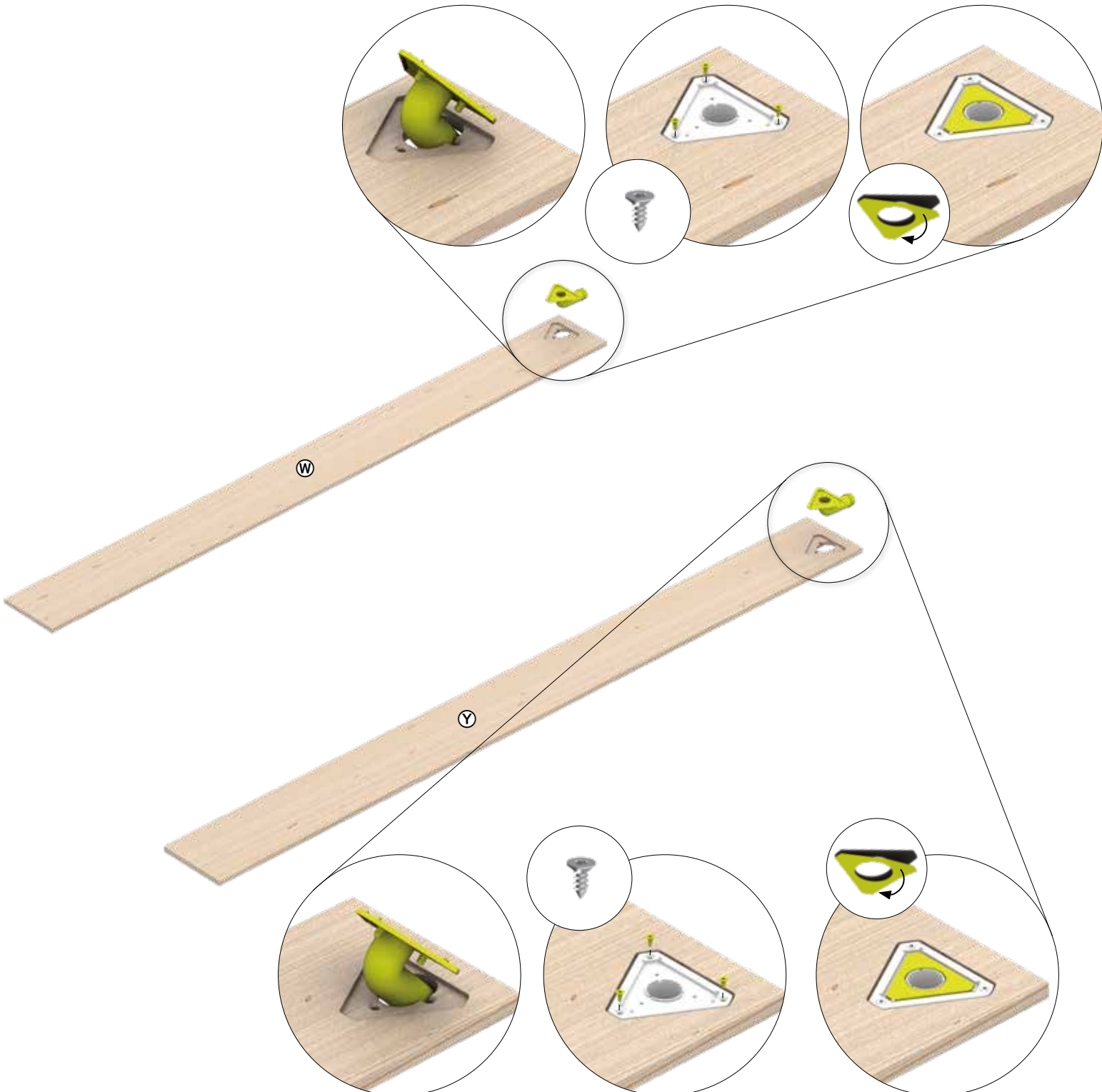

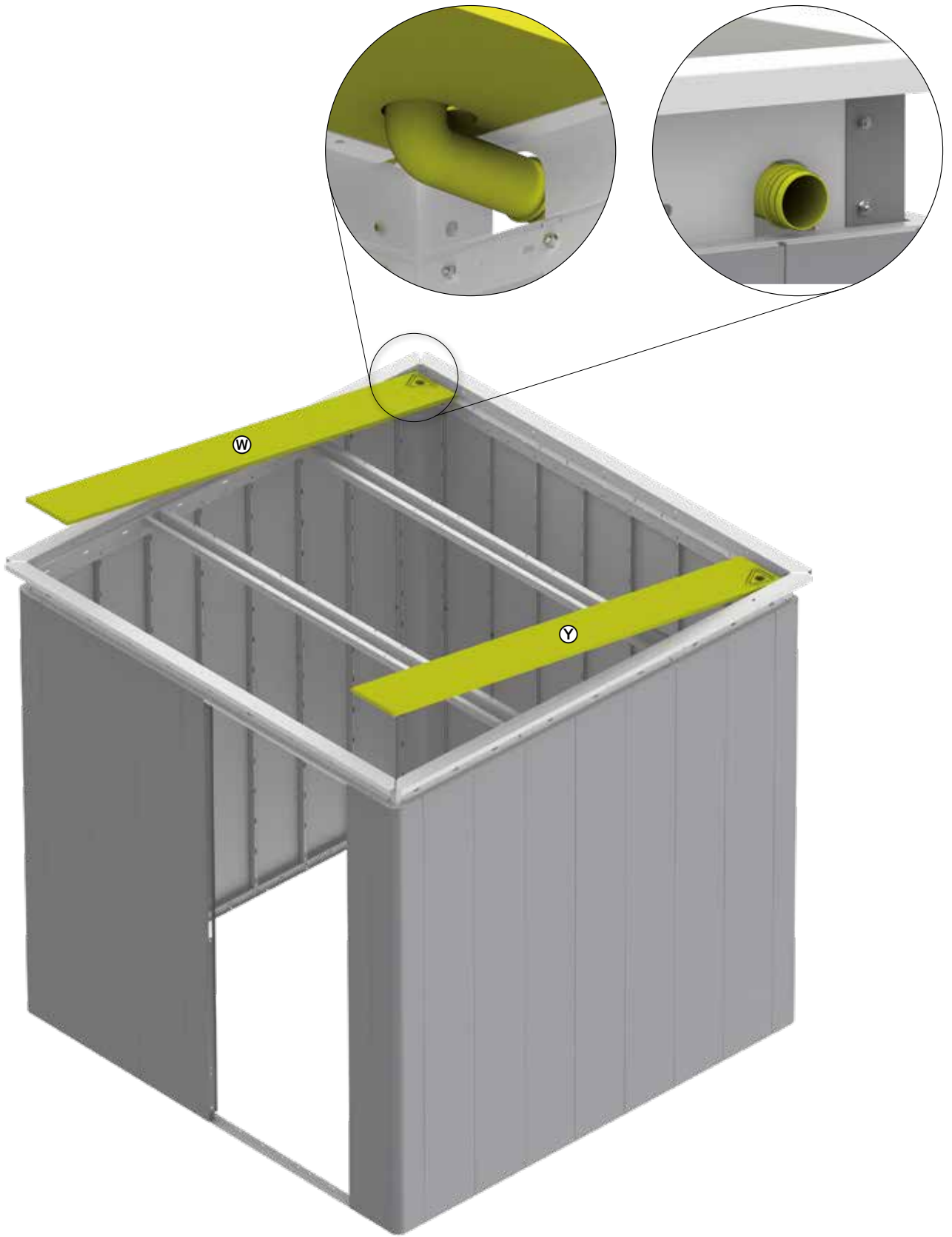

25.

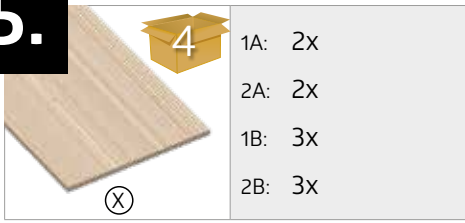

4

1A:	2x
2A:	2x
1B:	3x
2B:	3x

⊗

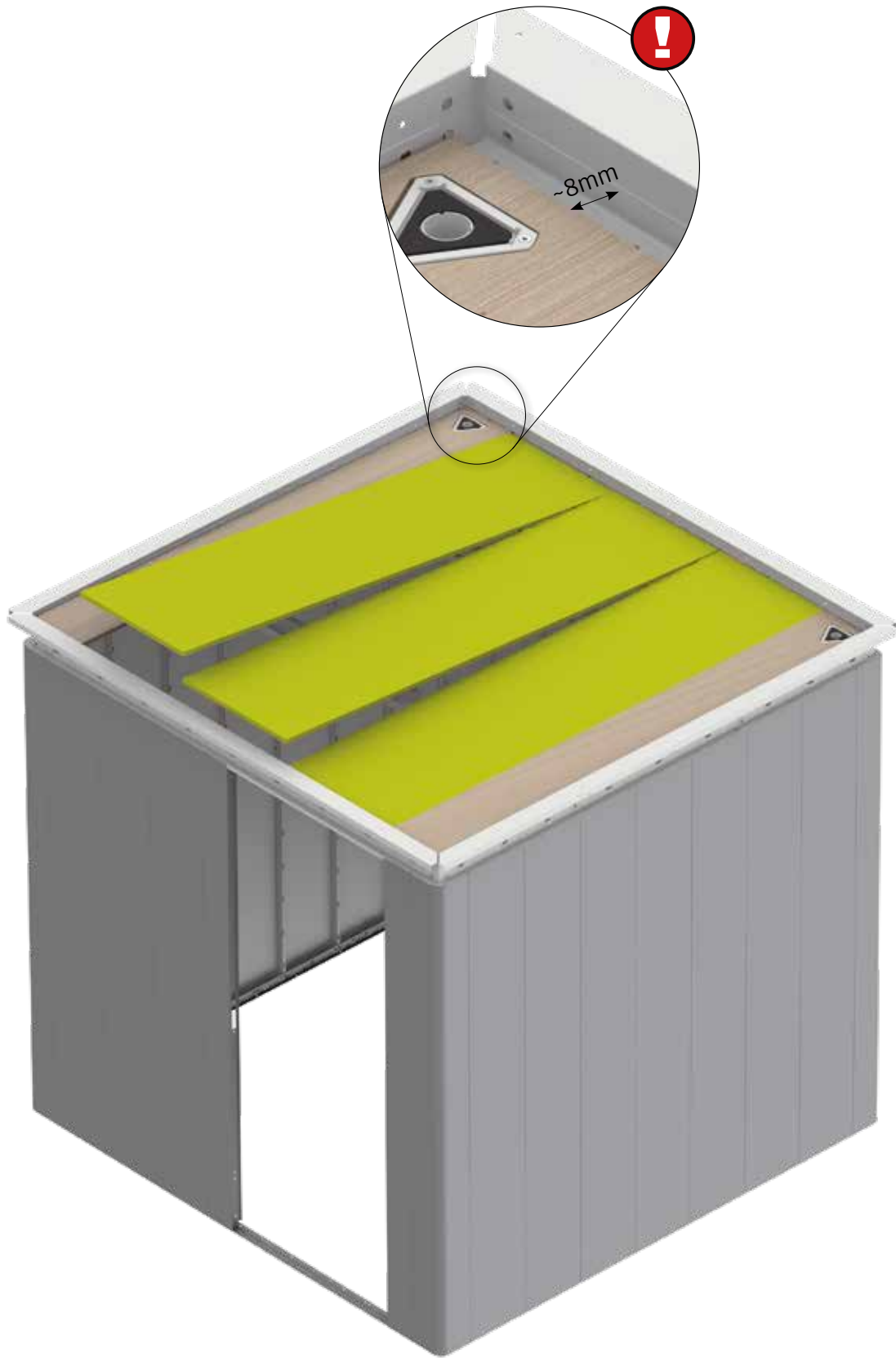

26.

RECHTWINKELIG EINRICHTEN

- GB Rectangular adjusted
- FR Ajuster en forme rectangulaire
- NL Rechthoekig instellen
- ES Colóquelo en ángulo recto
- IT Installare ad angolo retto
- DK Indstil vinkelret
- SE Ställ in rät vinkel
- NO Settes opp i rett vinkel
- PL Ustawić prostopadle
- SK Zrovnat' do pravého uhla
- SI Pripravite in postavite kvadrat
- CZ Srovnat' do pravého úhlu
- HU Derékszögbe beállítani
- HR Kvadrat osnove

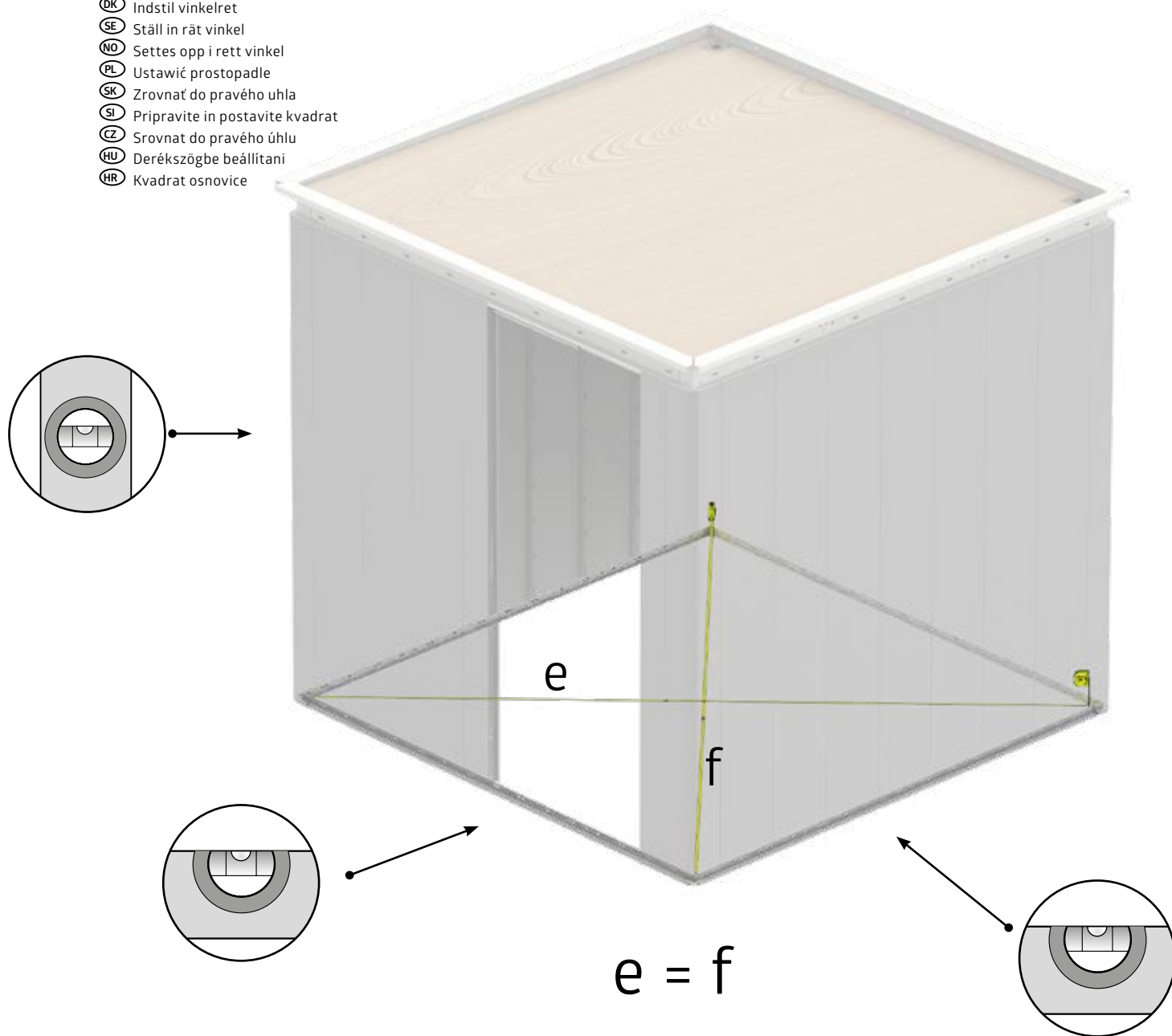

ZIEHEN SIE JETZT ALLE SCHRAUBVERBINDUNGEN FEST AN!

Tighten now all nuts and connections securely! - Serrez maintenant les vis à fond! - Draai nu alle schroeven vast! - Ahora puede apretar y fijar todos los tornillos y tuercas - Adesso serrare a fondo tutti i dadi - Fastspænd nu alle bolt-/skruerforbindelser! Dra nu át alla skruvförband ordentligt! - Stram nå alle muttere og tilkoblinger! - Teraz dokręć wszystkie śruby - Teraz utiahnite všetky spoje! - Zdaj varno privijte vse matice in povezave! - Nyní utáhněte všechny spoje! - Most húzza meg jól az összes csavart! - Sada čvrsto zategnite sve matice i spojeve!

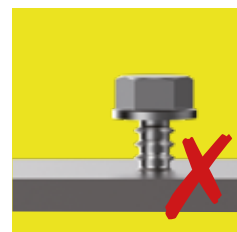
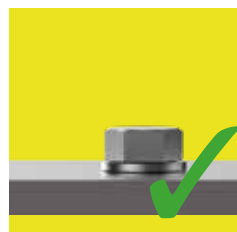

27.

5 x 20



7

1A: 32x

2A: 32x

1B: 48x

2B: 48x

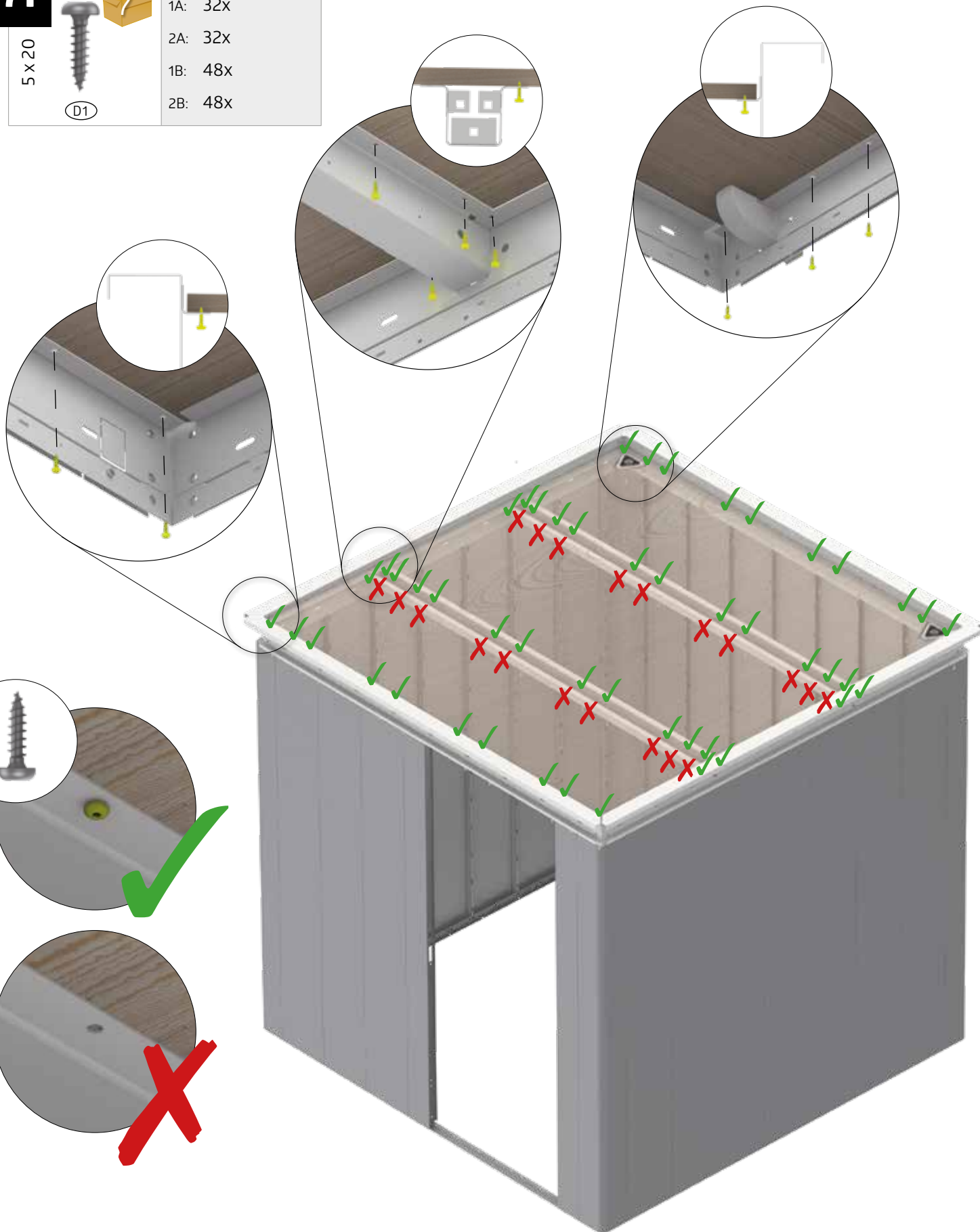

Ziehen Sie jetzt alle Schraubverbindungen fest an!

Tighten now all nuts and connections securely! - Serrez maintenant les vis à fond! - Draai nu alle schroeven vast! - Ahora puede apretar y fijar todos los tornillos y tuercas - Adesso serrare a fondo tutti i dadi - Fastspænd nu alle bolt-/skruerforbindelser!

28.



- 1A: 1X (880 mm)
- 2A: 1X (880 mm)
- 1B: 1X (880 mm)
- 2B: 1X (880 mm)

ⓐ

OPTION Doppeltür

Double door - Deuxième battant de porte -
Tweede deurvleugel - Secondo battente -
puerta doble - Dobbeltør





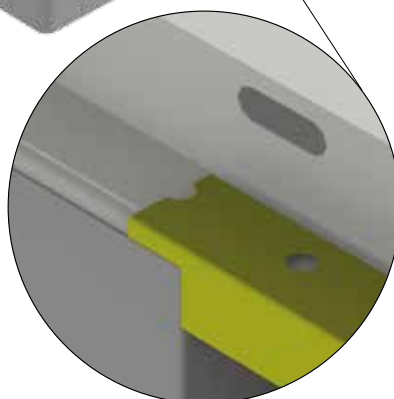
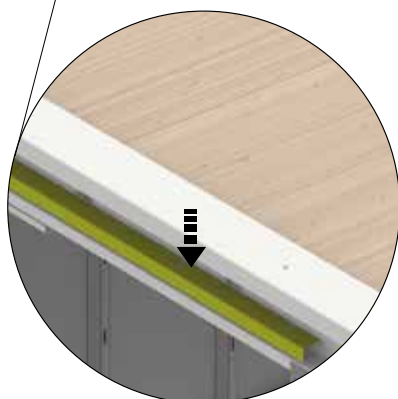

- 1B: 1X (1720 mm)
- 2B: 1X (1720 mm)

ⓐ







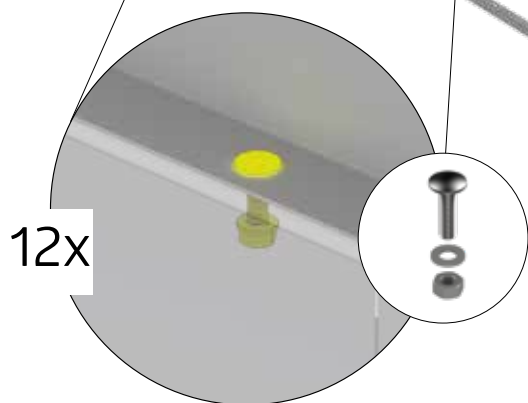
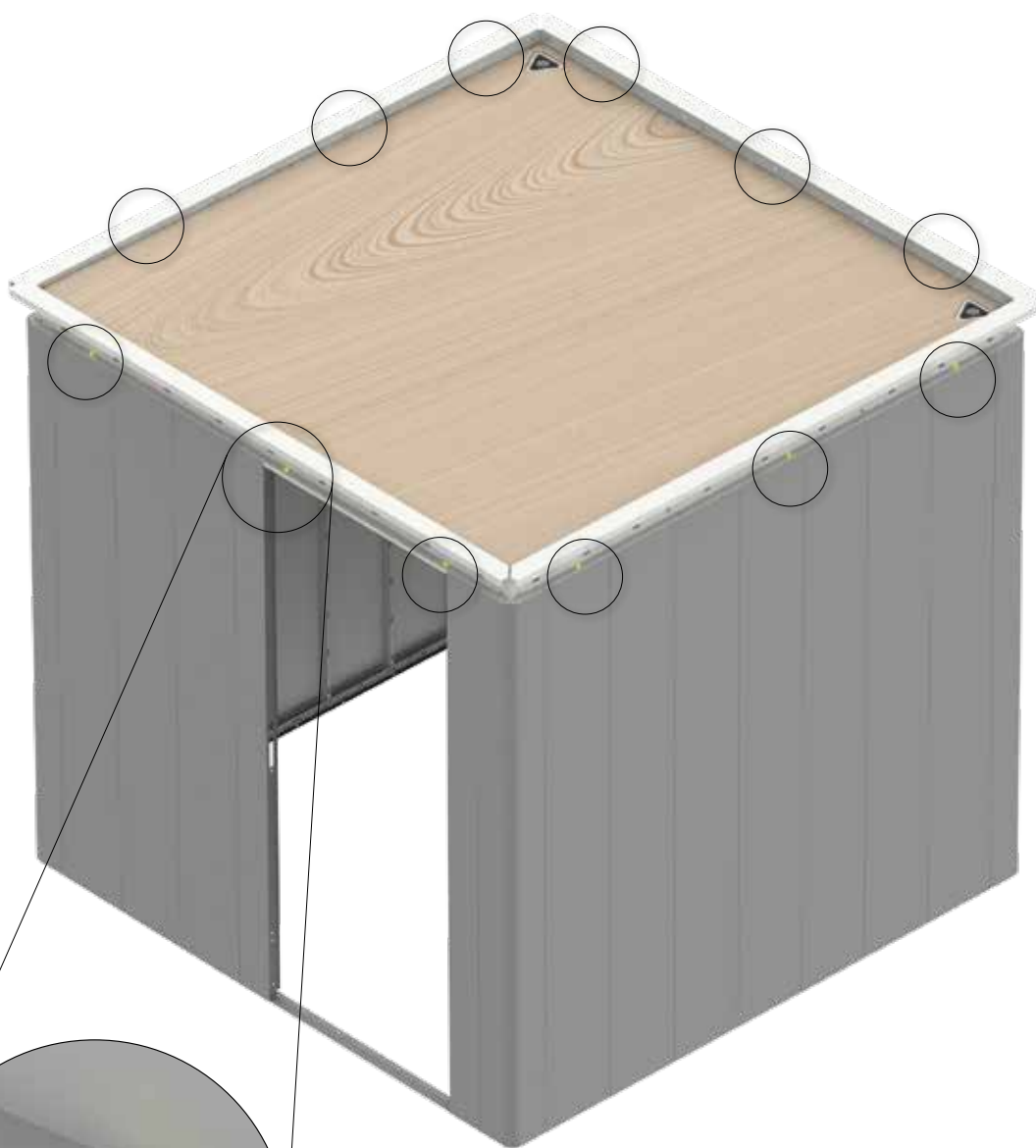
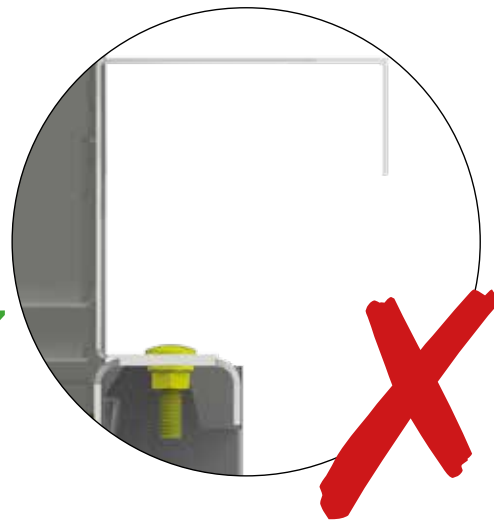





29.

M5 x 18 D1		1A: 12x
		2A: 12x
		1B: 12x
		2B: 12x



30.

 <p>Ⓣ</p>	 <p>1A: 2x 2A: 2x 1B: 2x 2B: 2x</p>	 <p>ⓐⓉ</p>	 <p>1A: 2x 2A: 2x 1B: 2x 2B: 2x</p>	<p>4,8 x 13</p>  <p>ⓓ2</p>	 <p>1A: 4x 2A: 4x 1B: 4x 2B: 4x</p>
 <p>ⓓ2</p>	 <p>1A: 2x 2A: 2x 1B: 2x 2B: 2x</p>	 <p>ⓐⓇ</p>	 <p>1A: 2x 2A: 2x 1B: 2x 2B: 2x</p>		

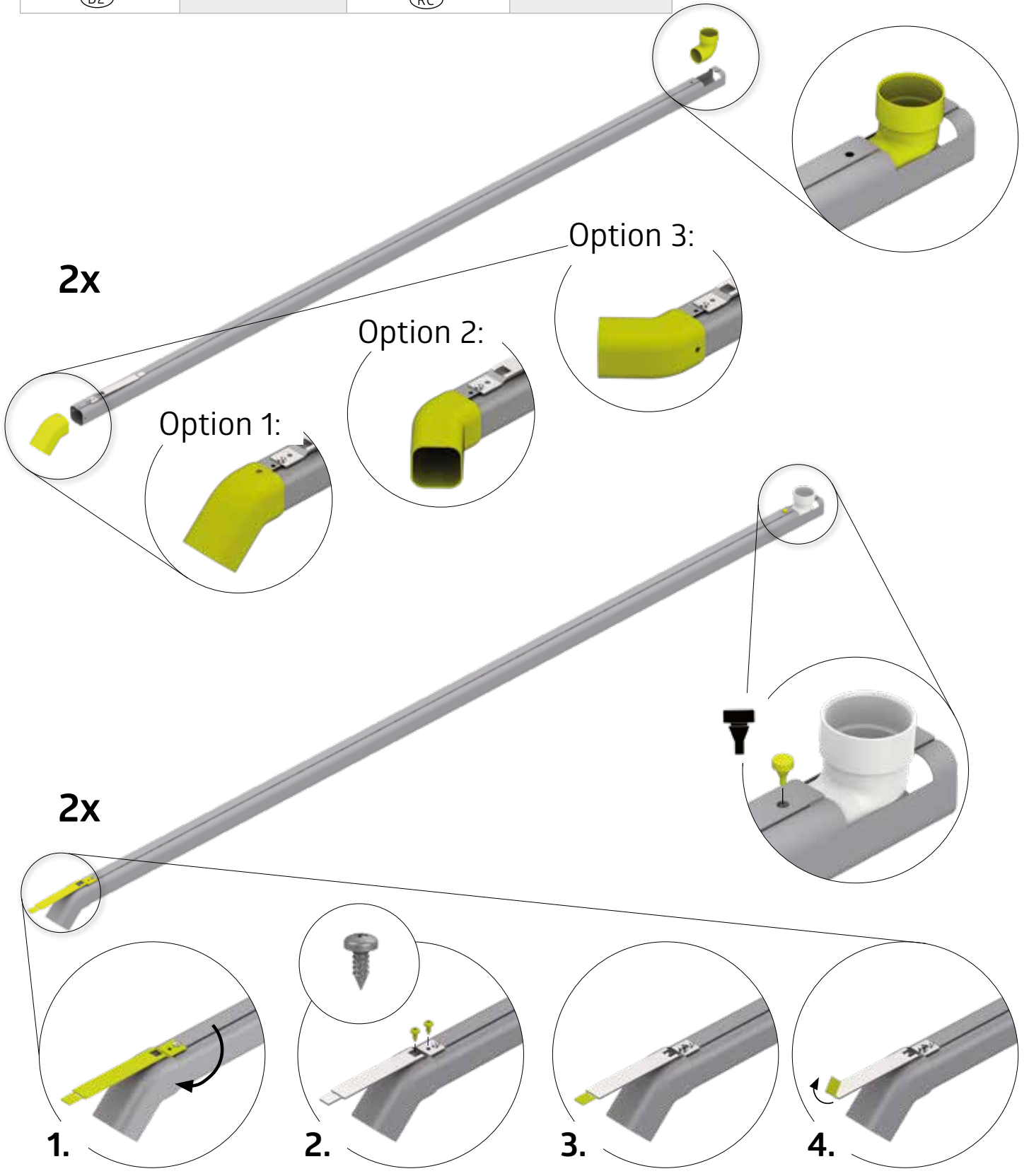



31.

Ansicht Rückseite

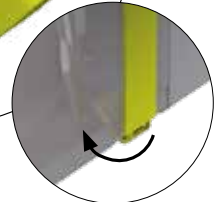
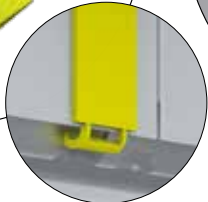
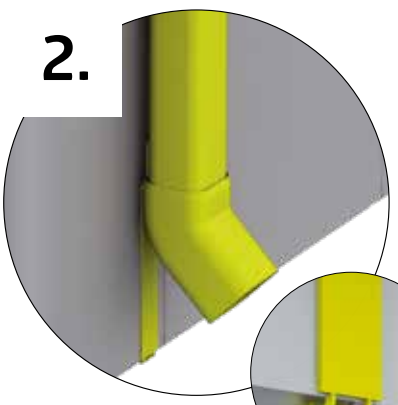
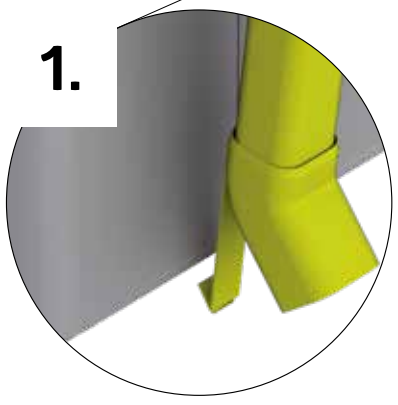
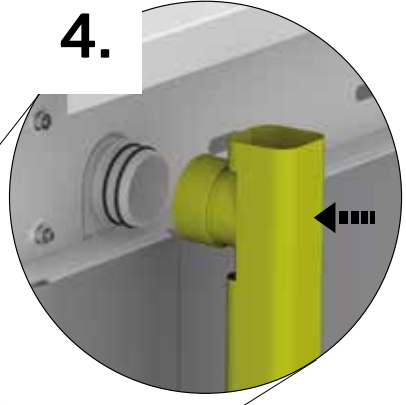
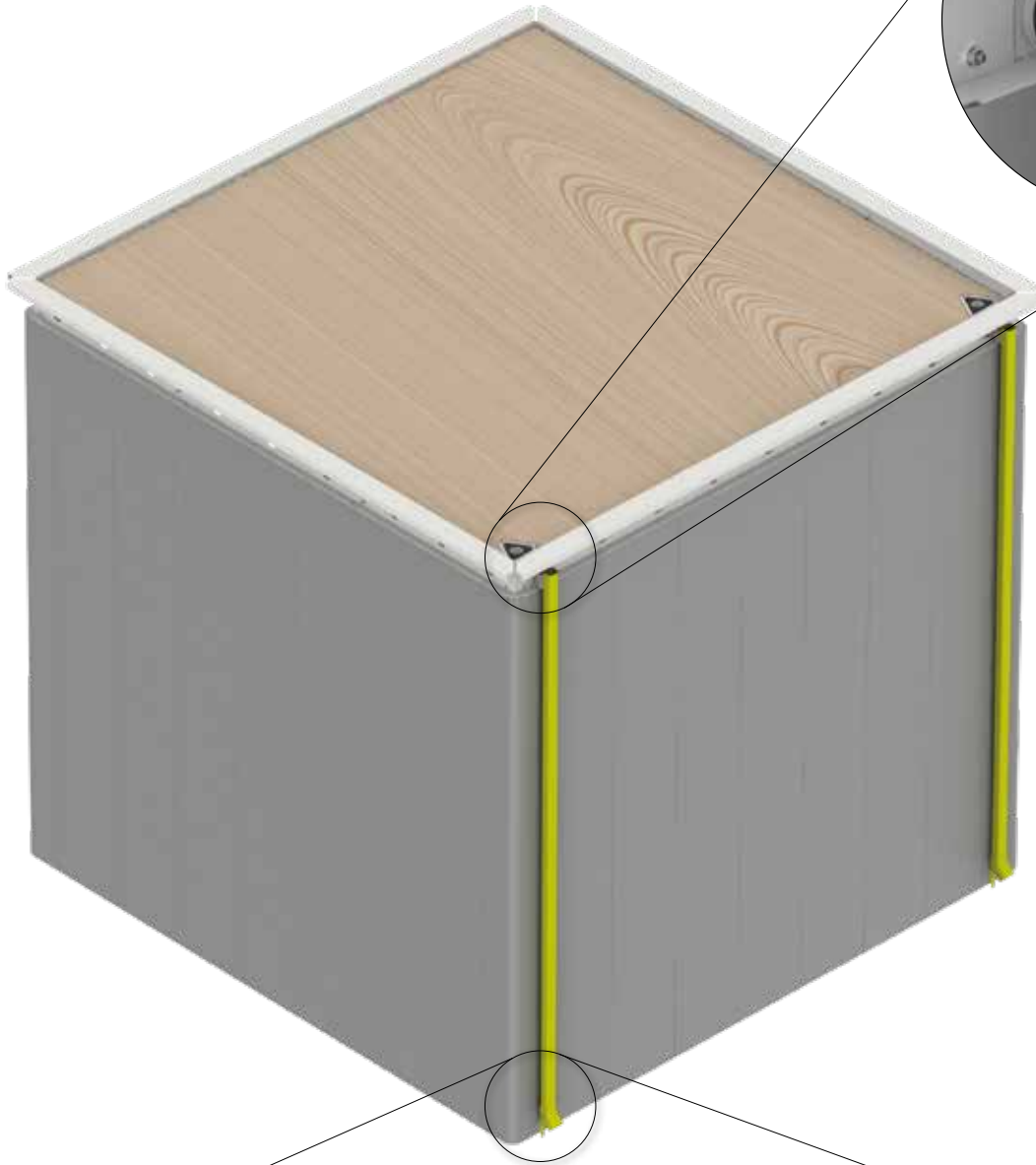
Back side view · Vue arrière · Rugaanzicht · Vista trasera · Se bagside · Bakifrån! · Sett bakfra · Widok z tyłu · Pohľad zozadu · Pogled od zadaj · Pohled zezadu · Hátsó nézet · Pogled sa stražnje strane



32.

		1A: 1X (1910x1910 mm)
		2A: 1X (2470x1910 mm)
		1B: 1X (2470x1910 mm)
		2B: 1X (2470x2470 mm)

Mögliche Schweißnaht der Folie darf nicht im Gullybereich sein.

Ⓒ Possible welding seam of the membrane must not be in the gully area.

Ⓕ Le point de collage éventuel du film ne doit pas se trouver dans la zone de l'évacuation d'eaux.

Ⓖ Mogelijk laspunt van de folie mag niet in de buurt van de afloop liggen.

Ⓔ El posible punto de soldadura de la lámina no debe estar en la zona del desagüe.

Ⓗ L'eventuale punto di giunzione della pellicola non deve trovarsi nell'area della bocchetta di scarico acque.

Ⓓ Det mulige svejsepunkt på folien må ikke være i kløften.



33.

Ansicht Rückseite

Back side view · Vue arrière · Rugaanzicht · Vista trasera · Se bagside · Bakifrån! · Sett bakfra · Widok z tyłu · Pohľad zozadu · Pogled od zadaj · Pohled zezadu · Hátsó nézet · Pogled sa stražnje strane

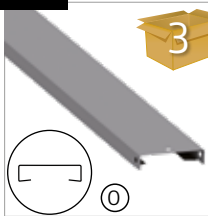
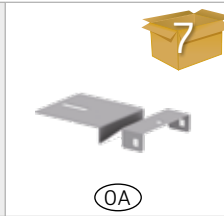
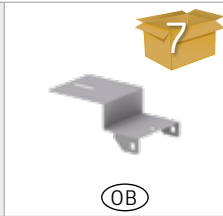
 <p>3</p>	<p>1A: 2X (1573 mm) 2A: 2X (2133 mm) 1B: 2X (1573 mm) 2B: 2X (2133 mm)</p>	 <p>7</p>	<p>1A: 2X 2A: 2X 1B: 2X 2B: 2X</p>	 <p>7</p>	<p>1A: 2X 2A: 2X 1B: 2X 2B: 2X</p>
---	--	--	--	--	--



ACHTUNG! DACHSTREBE FÜR ALLE FARBEN IMMER QUARZGRAU.



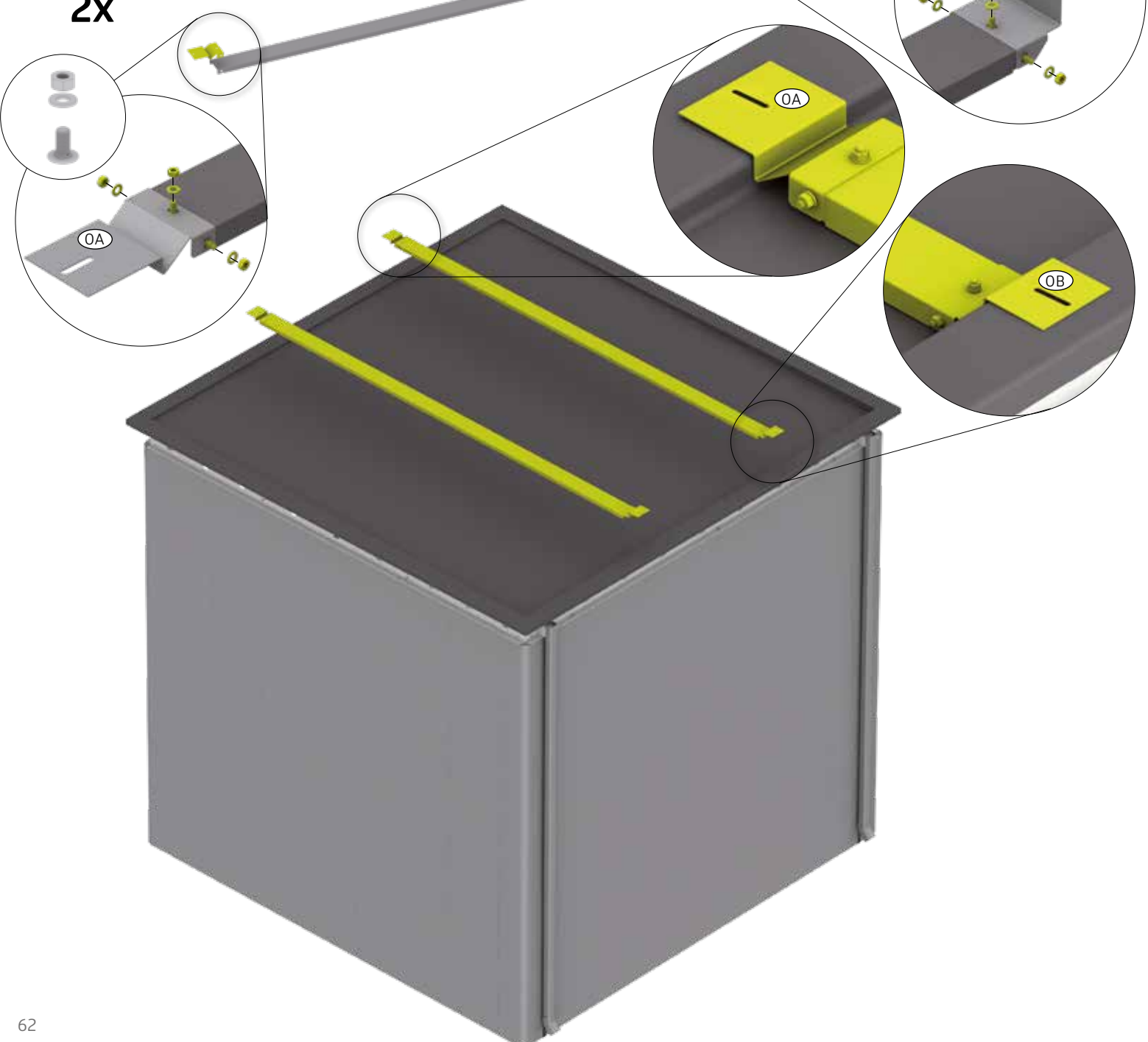

- Ⓒ CAUTION! Roof strut for all colours always quartz grey.
- Ⓕ ATTENTION : La traverse du toit pour toutes les couleurs d'abris est gris quartz.
- Ⓖ OPGELET: de daksteunen zijn altijd kwartsgrijs (ongeacht de kleur van de berging).
- Ⓔ ATENCIÓN: El puntal del techo para todos los colores siempre es gris cuarzo.
- Ⓙ ATTENZIONE: montante del tetto per tutti i colori sempre grigio quarzo.
- Ⓝ Bemærk! Tagstiver til alle farver er altid kvartsgrå metallic.
- Ⓢ UPPMÄRKSAMHET! Takbalken för alla färger alltid kvartsgrå.
- Ⓝ FORSIKTIG! Takstiver for alle farger alltid kvartsgrå.
- Ⓟ UWAGA! Mocowania folii dla wszystkich kolorów zawsze kwarcowo-szary.
- Ⓚ POZOR! Strešná vzpera je vždy vo farbe sivý kremeň.
- Ⓜ POZOR! Strešni opornik za vse barve je vedno kremenasto siv.
- Ⓒ POZOR! Strešni vspěra je vždy v barvě šedý křemen.
- Ⓓ Figyelem! A tetőmerevítő minden szín esetén kvarcászürke.
- Ⓗ OPREZ! Krovni nosač za sve boje uvijek kvarcno siva.

<p>M5 x 10</p>  <p>7</p>	<p>1A: 12x 2A: 12x 1B: 12x 2B: 12x</p>
---	--

2x

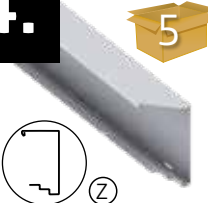















34.

		1A: 3X (1737 mm) 2A: 1X (1737 mm) 2X (2297 mm) 1B: 1X (2297 mm) 2X (1737 mm) 2B: 3X (2297 mm)			1A: 2X 2A: 2X 1B: 2X 2B: 2X



FOLIE ANDRÜCKEN!

-  Push down on the membrane!
-  Presser le film!
-  Folie aandrukken!
-  Presione sobre el papel de aluminio!
-  Premere il telo!
-  Tryk folien på!
-  Tryck på folien!
-  Skyv ned på membranen!
-  Docisnąć folię!
-  Zatlačte na membránu!
-  Potisnite membrano navzdol!
-  Zatlačte na membránu!
-  Nyomja be a fóliát!
-  Pritisnite membranu dolje!

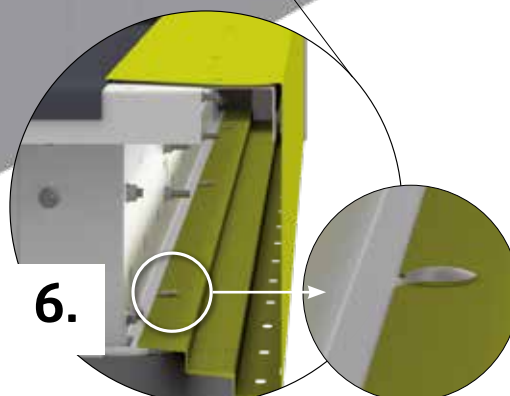
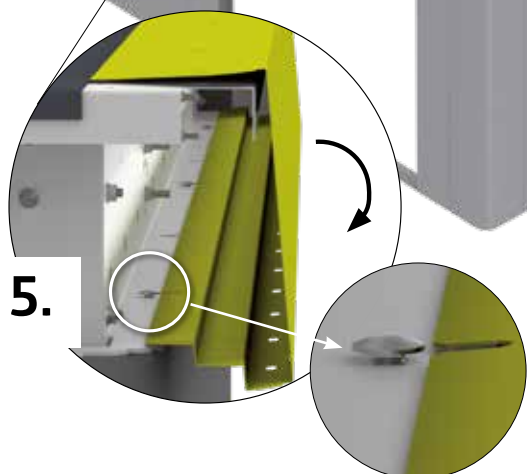
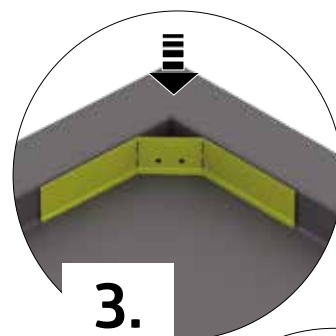
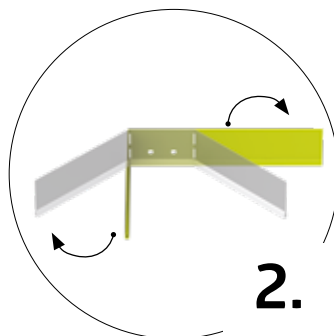

35.

Ansicht Rückseite

Back side view · Vue arrière · Rugaanzicht · Vista trasera · Se bagside · Bakifrån! · Sett bakfra · Widok z tyłu · Pohľad zozadu · Pogled od zadaj · Pohled zezadu · Hátsó nézet · Pogled sa stražnje strane

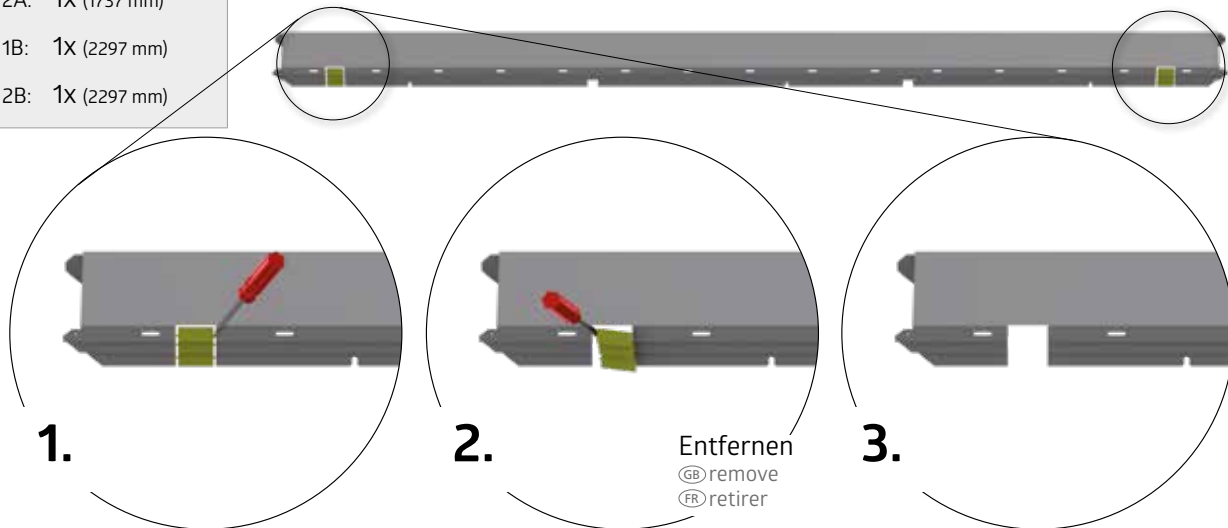
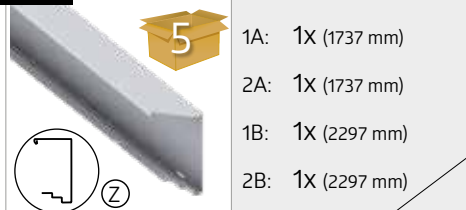

FOLIE ANDRÜCKEN!

- GB** Push down on the membrane!
- FR** Presser le film!
- NL** Folie aandrukken!
- ES** Presione sobre el papel de aluminio!
- IT** Premere il telo!
- DK** Tryk folien på!
- SE** Tryck på folien!
- NO** Skyv ned på membranen!
- PL** Docisnąć folię!
- SK** Zatlačte na membránu!
- SI** Potisnite membrano navzdol!
- CZ** Zatlačte na membránu!
- HU** Nyomja be a fóliát!
- HR** Pritisnite membranu dolje!

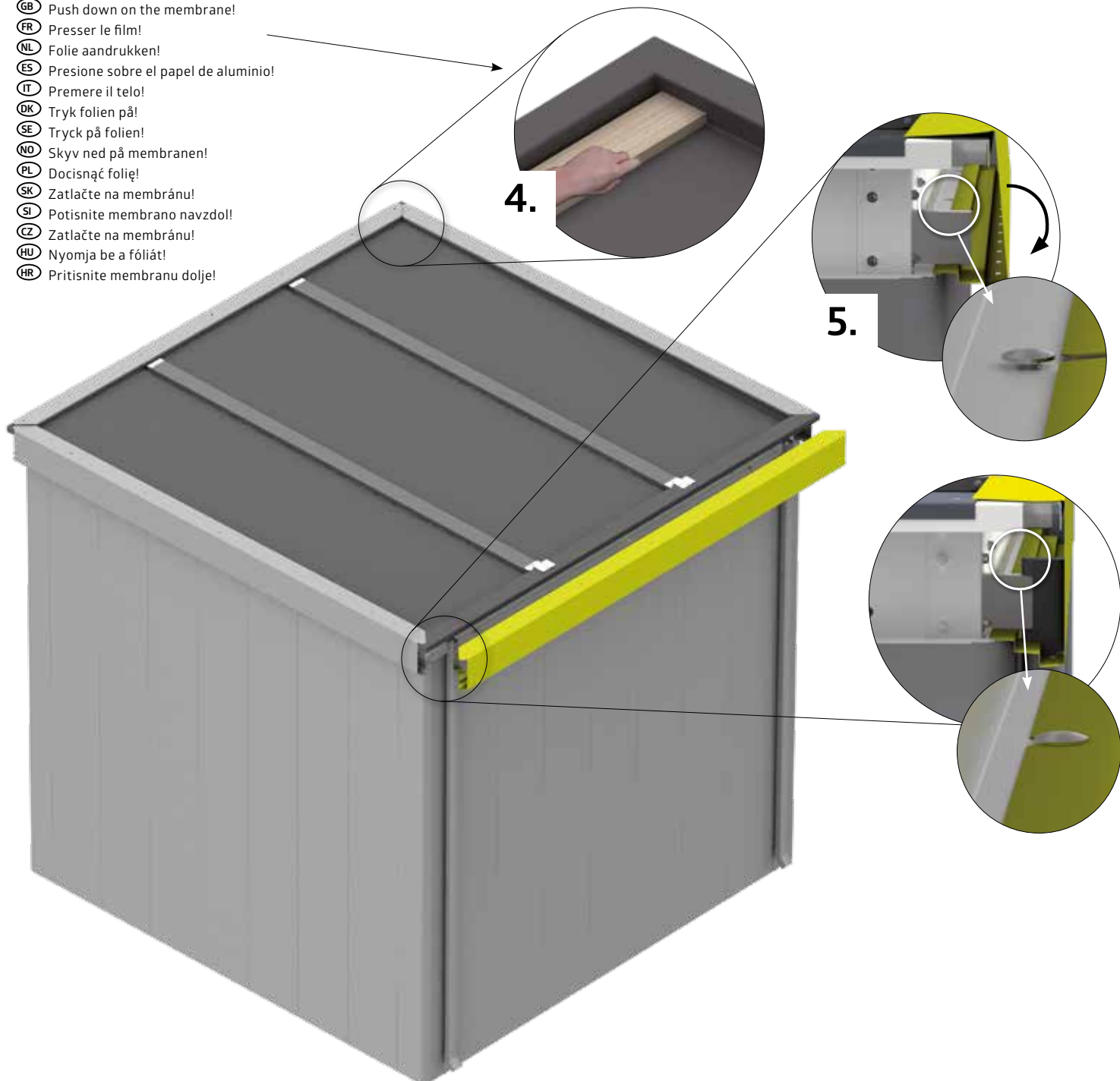

36.

4,8 x 19



1A: 12x
2A: 16x
1B: 16x
2B: 20x

(D1)



DICHTSCHEIBE VERWENDEN!

- (GB) Use sealing washer!
- (FR) Utiliser une rondelle d'étanchéité!
- (NL) Gebruik de afdichtingsschijf!
- (ES) ¡Usar la arandela de sellado!
- (IT) Utilizzare la guarnizione!
- (DK) Anvend tætningskive!
- (SE) Använd tätningbricka!
- (NO) Bruk tetningskive!
- (PL) Użyj podkładki uszczelniającej!
- (SK) Použite tesniace podložku!
- (SI) Uporabite tesnilno podložko!
- (CZ) Použijte těsnící podložku!
- (HU) Használja a tömítő alátétet!
- (HR) Koristite brtvenu podložku!





DACHSTREBE MITVERSCHRAUBEN!

- (GB) Screw to the roof strut!
- (FR) Vissez les supports de toit!
- (NL) Schroef de draagbalk van het dak vast!
- (ES) ¡Atornille el soporte del techo!
- (IT) Avvitare il supporto del tetto!
- (DK) Skru tagstiveren sammen!
- (SE) Skruva fast tillsammans med takbalken!
- (NO) Skru til takstativet!
- (PL) Dokręcić mocowania folii!
- (SK) Naskrutkujte do strešnej vzpery!
- (SI) Privijte na strešno oporo!
- (CZ) Našroubujte do střešní vzpěry!
- (HU) Csavarozza össze a tetőmerevítőt!
- (HR) Vijak na krovni nosač!



37.



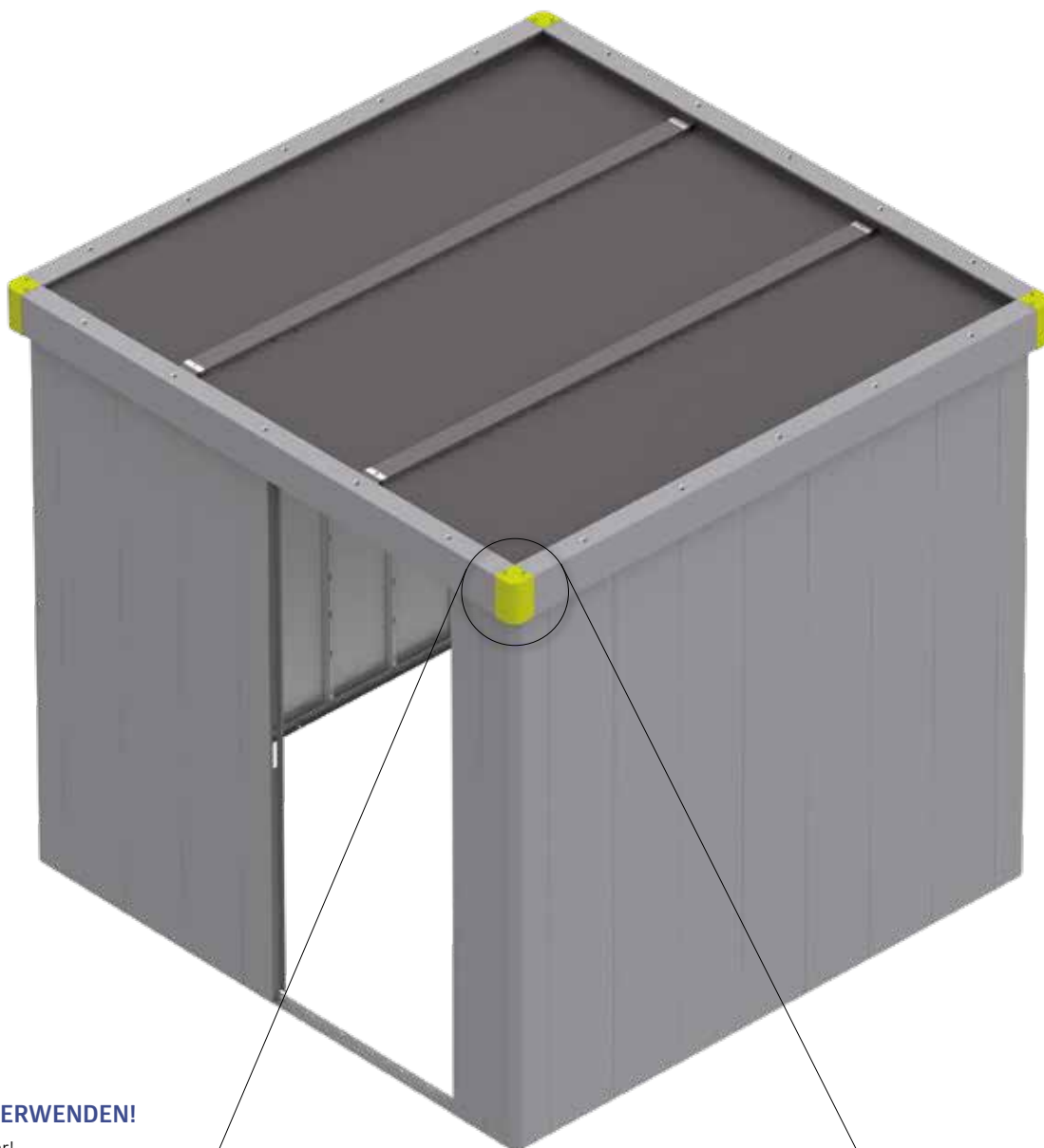



 <p>5</p> <p>(AJ)</p>	<p>1A: 4x 2A: 4x 1B: 4x 2B: 4x</p>	 <p>7</p> <p>4,8 x 19</p> <p>(D1)</p>	<p>1A: 8x 2A: 8x 1B: 8x 2B: 8x</p>	 <p>7</p> <p>3,9 x 13</p> <p>(D1)</p>	<p>1A: 8x 2A: 8x 1B: 8x 2B: 8x</p>
---	--	---	--	---	--

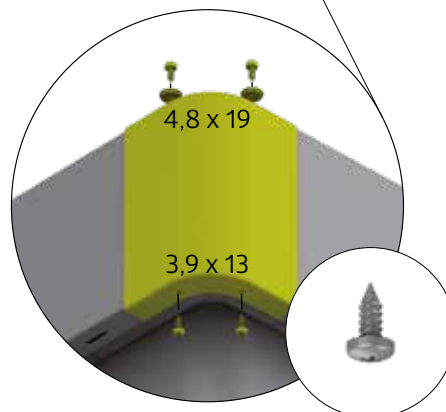
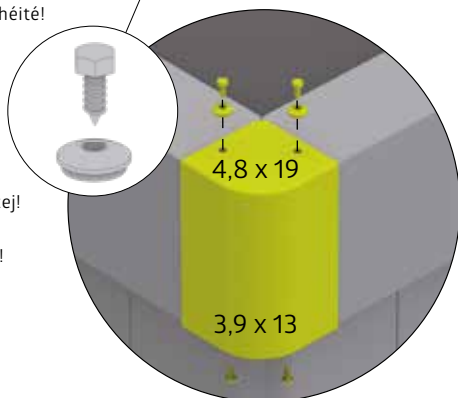

DICHTSCHEIBE VERWENDEN!

- (GB) Use sealing washer!
- (FR) Utiliser une rondelle d'étanchéité!
- (NL) Gebruik de afdichtingsschijf!
- (ES) !Usar la arandela de sellado!
- (IT) Utilizzare la guarnizione!
- (DK) Anvend tætningsskive!
- (SE) Använd tätningssbricka!
- (NO) Bruk tetningsskive!
- (PL) Użyj podkładki uszczelniającej!
- (SK) Použite tesniace podložku!
- (SI) Uporabite tesnilno podložko!
- (CZ) Použijte těsnící podložku!
- (HU) Használja a tömítő alátétet!
- (HR) Koristite brtvenu podložku!



 	 1A: 2x 2A: 2x 1B: 2x 2B: 2x	4,8 x 13  	 1A: 6x 2A: 6x 1B: 6x 2B: 6x
--	--	--	--

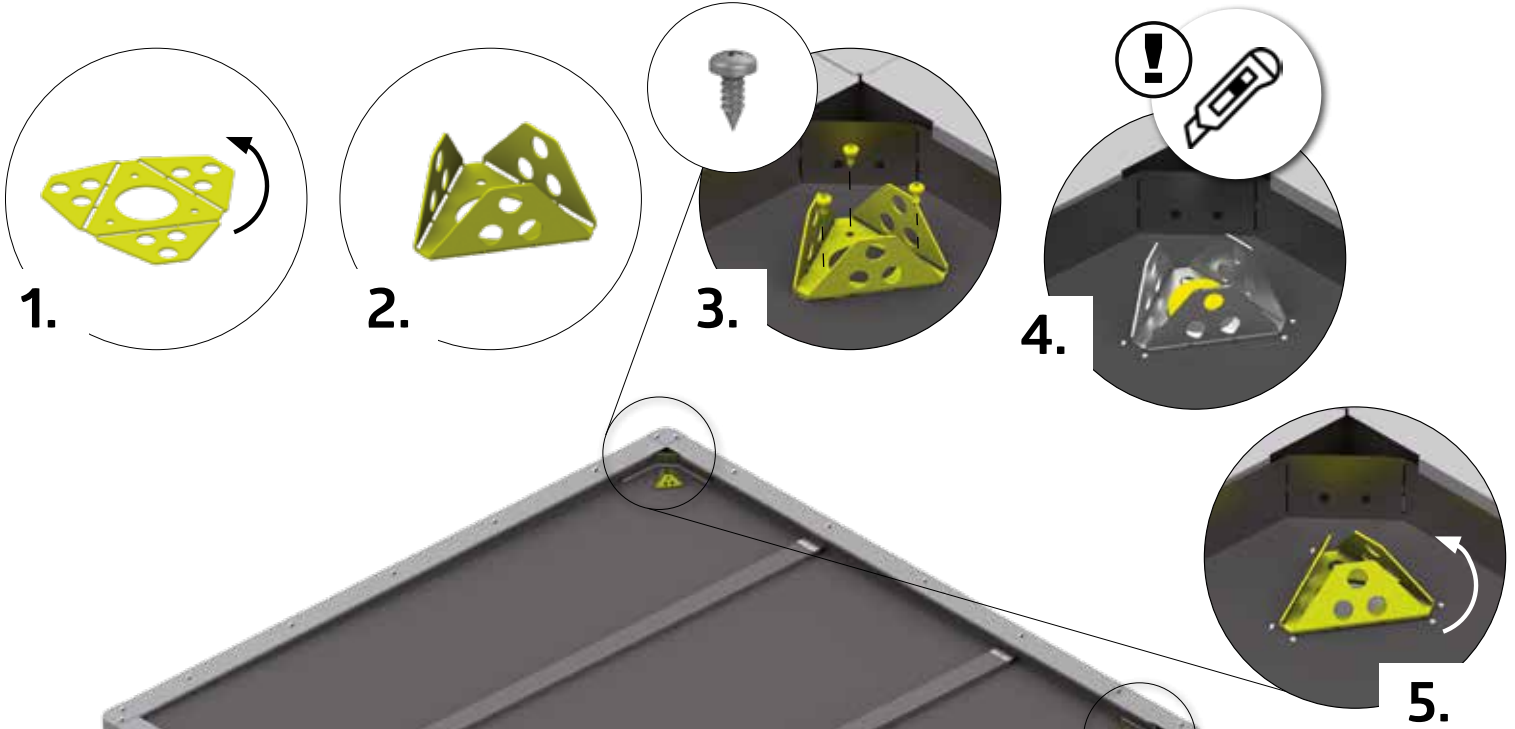

-  **FESTZIEHEN**
-  tighten
 -  serrez fort
 -  vastdraaien
 -  apriete
 -  serrare a fondo
 -  fastspænding
 -  Dra åt
 -  Stramme
 -  Dokręcić
 -  Dotiahnuť
 -  Zategnite
 -  Dotáhnout
 -  Erősén meghúzni
 -  Zategnite



EPDM-Dachfolie: Um die Lebensdauer der EPDM-Dachfolie zu verlängern, empfehlen wir die Beschwerung nach dem Aufbau mittels Terrassen-Gehwegplatten oder vergleichbare Beschwerungen (30x30x2/3/4 cm). (Seite 15)

 In order to prolong the life of the EPDM roofing membrane, we recommend weighting it down after installation using patio slabs (30x30x2/3/4 cm). (Page 15)

 Afin de prolonger la durée de vie de la feuille de toiture EPDM, il est recommandé de la lester après la pose avec des dalles en béton (30x30x2/3/4 cm). (Pages 15)

 Om de levensduur van de EPDM dak folie te verlengen, raden wij aan deze na plaatsing te verzwaren met terras-padtegels (30x30x2/3/4 cm). (Pagina 15)

 Para prolongar la vida útil de la lámina de caucho EPDM, se recomienda reforzarla después de su instalación con baldosas para exteriores o terraza (30x30x2/3/4 cm). (Páginas 15)

 Al fine di prolungare la vita della guaina EPDM, si consiglia di appesantirla dopo l'installazione con mattonelle da patio (30x30x2/3/4 cm). (Pagine 15)

 For at forlænge EPDM-tagfoliens levetid, anbefaler vi at der lægges fliser (30x30x2/3/4 cm). på folien efter opbygningen. (Side 15)



Bodenrahmen - Doppeltür

Floor frame double door · Cadre de sol deuxième battant de porte · Bodemframe tweede deurvleugel · Marco de suelo segundo battente · Telaio perimetrale puerta doble · Bundramme dobbeltdør · Bottenram dubbeldörr · Gulvramme dobbelt dør · Rama podłogowa podwójne drzwi · Podlahový rám dvojkřídlové dveře · Talni okvir dvojná vrata · Podlahový rám dvoukřídle dveře · Padlókeret duplaajtó · Podni okvir dvokrilna vrata

	<p>1B: 1x 2B: 1x</p>	<p>(ZD)</p>	<p>1B: 1x 2B: 1x</p>	<p>6,3 x 22</p> <p>(ZF)</p>	<p>1B: 1x 2B: 1x</p>
--	--------------------------	-------------	--------------------------	-----------------------------	--------------------------

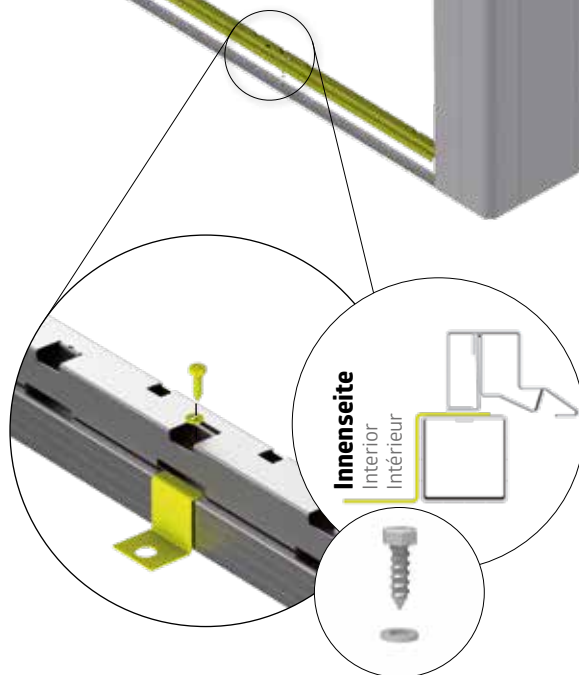
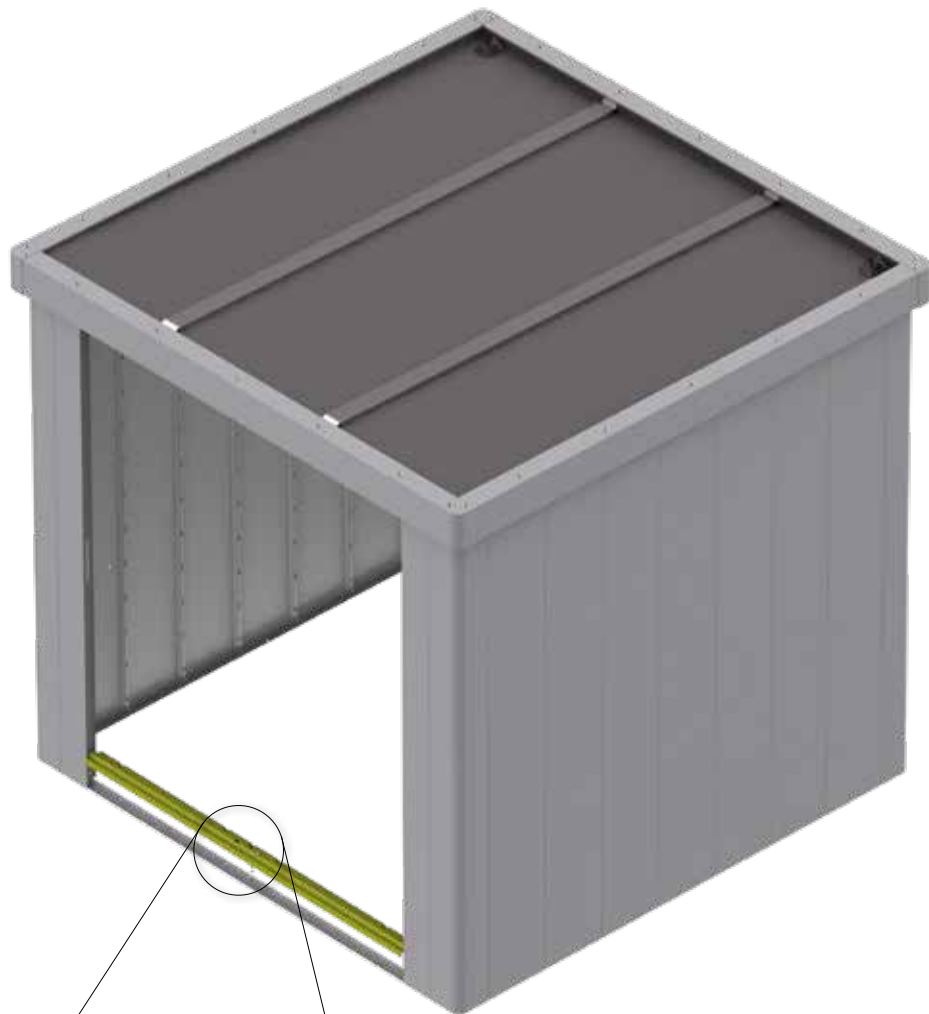









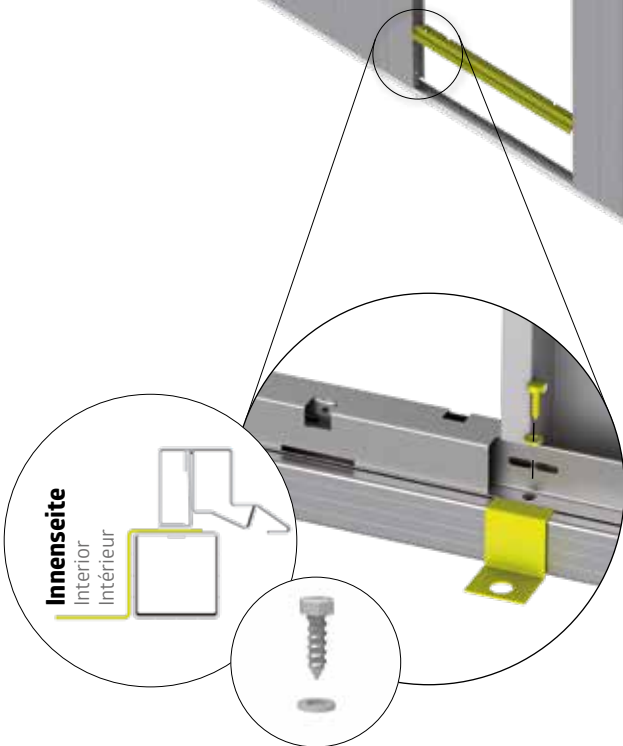
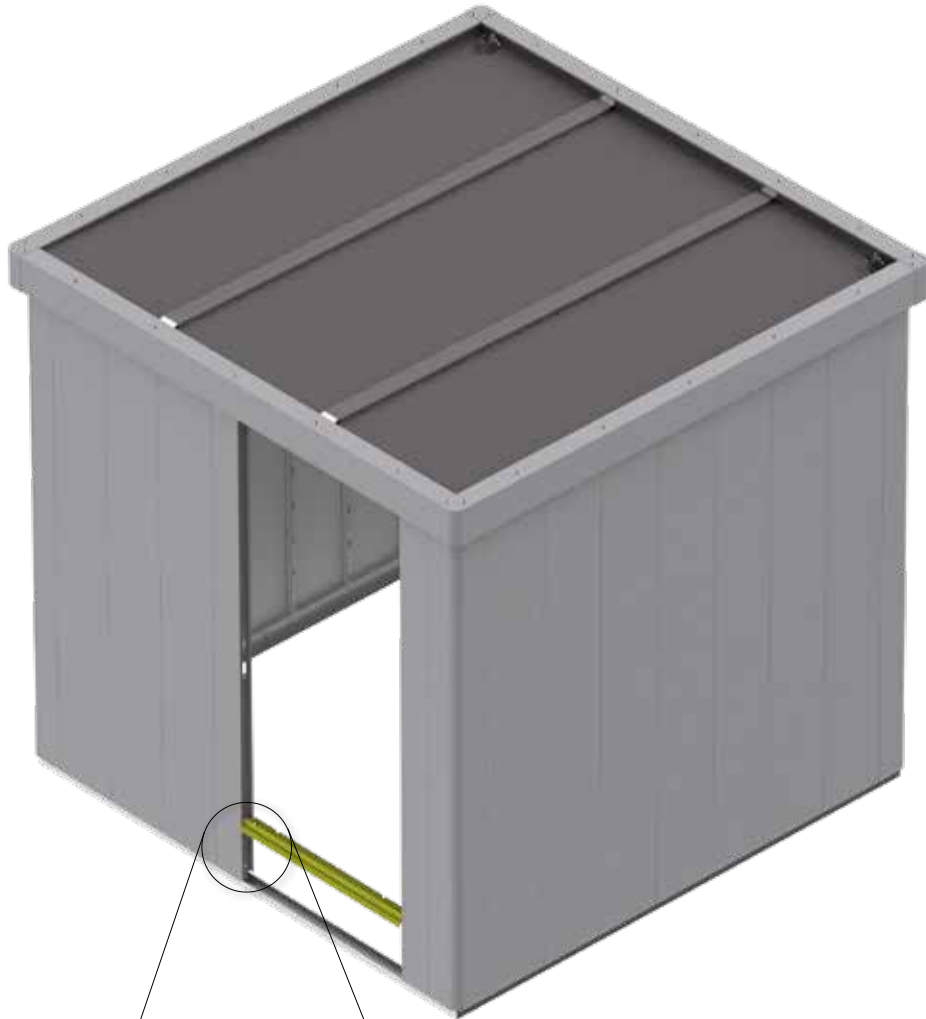

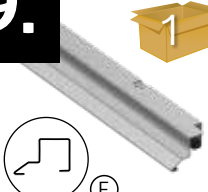

Bodenrahmen - Standardtür







Floor frame standard door · Cadre de sol porte standard · Bodemframe standaard deur · Marco de suelo puertas estándar · Telaio perimetrale porta standard · Bundramme standarddør · Bottenram standarddörr · Gulvramme standard dør · Rama podłogowa drzwi standardowe · Podlahový rám štandardné dvere · Talni okvir standardna vrata · Podlahový rám štandardní dveře · Padlókeret standard ajtó · Podni okvir standardna vrata

	1A: 1x		1A: 1x	6,3 x 22 	1A: 1x
	2A: 1x		2A: 1x		2A: 1x
	1B: 1x		1B: 1x		1B: 1x
	2B: 1x		2B: 1x		2B: 1x

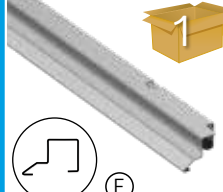
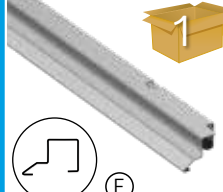







39.

    	 1	1A: 1X (835 mm) 2A: 1X (835 mm) 1B: 1X (835 mm) 2B: 1X (835 mm)
	 7	1A: 2X 2A: 2X 1B: 2X 2B: 2X
	4,8 x 19	  
		

OPTION Doppeltür Double door - Deuxième battant de porte - Tweede deurvleugel - Secondo battente - puerta doble - Dobbeldør	  	 1	1B: 1X (1675 mm) 2B: 1X (1675 mm)
		4,8 x 19	  

Bei Verwendung der Bodenschwellen-Rampe überspringen Sie diesen Schritt!

-  **GB** When using the threshold access ramp (optional accessory), please skip this step!
-  **FR** Si vous utilisez le seuil de porte (accessoire) veuillez passer les étapes!
-  **NL** Bij toepassing van de oprijplaat (toebehoren) overslaan stap!
-  **ES** Si utiliza rampa de acceso (accesorio opcional) omite este paso en el montaje
-  **IT** Se usi la rampa di accesso (accessorio opzionale), puoi saltare questo passaggio
-  **DK** Spring dette skridt over, hvis du bruger gulvrampe!

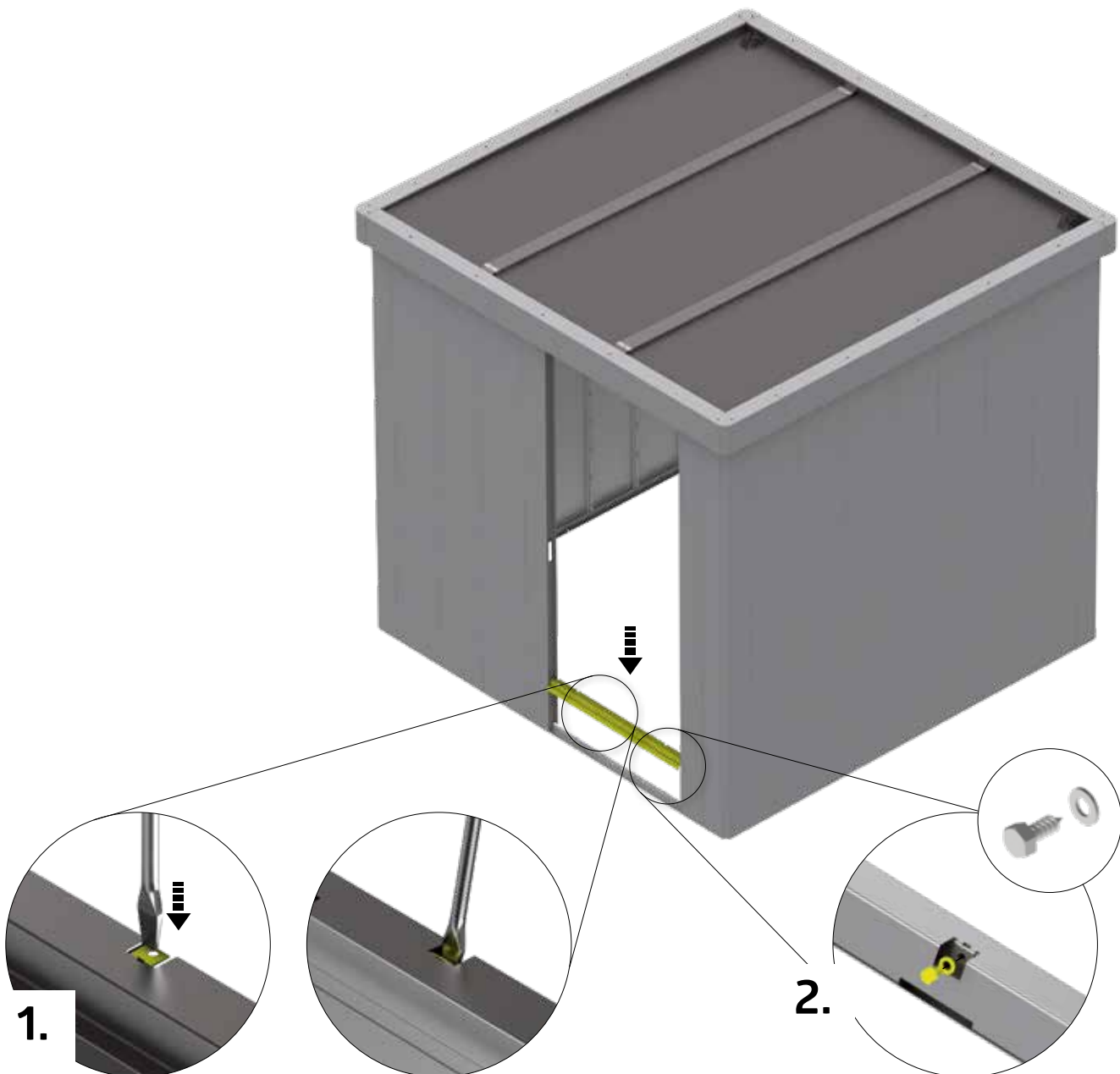

40.

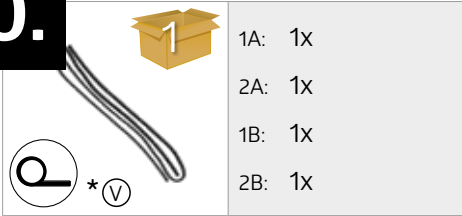

* TEIL ENTFÄLLT BEI DER DOPPELTÜR













- Ⓒ**GB** Part not required when double doors are fitted
- Ⓒ**FR** La pièce est supprimée pour la double portes
- Ⓒ**NL** Deel vervalt bij de dubbele deur
- Ⓒ**ES** Pieza no es necesaria en caso de puerta doble
- Ⓒ**IT** Pezzo non può essere utilizzato per la variante porta a due battenti
- Ⓒ**DK** Del ikke nødvendig med dobbeltdør
- Ⓒ**SE** Den här delen utgår vid dubbeldörr
- Ⓒ**NO** Del er ikke nødvendig når dobbeltdør er montert
- Ⓒ**PL** Element nie występuje w drzwiach podwójnych
- Ⓒ**SK** Súčasťka nie je potrebná, ak sú namontované dvojité dvere
- Ⓒ**SI** Del ni potreben, če so nameščena dvojna vrata
- Ⓒ**CZ** Součástka není potřebná, jsou-li namontovány dvojité dveře
- Ⓒ**HU** Ez a tétel a duplaajtó esetén elmarad
- Ⓒ**HR** Rezervni ključ čuvajte odvojeno u slučaju da trebate kopirati



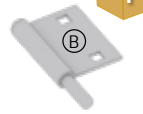







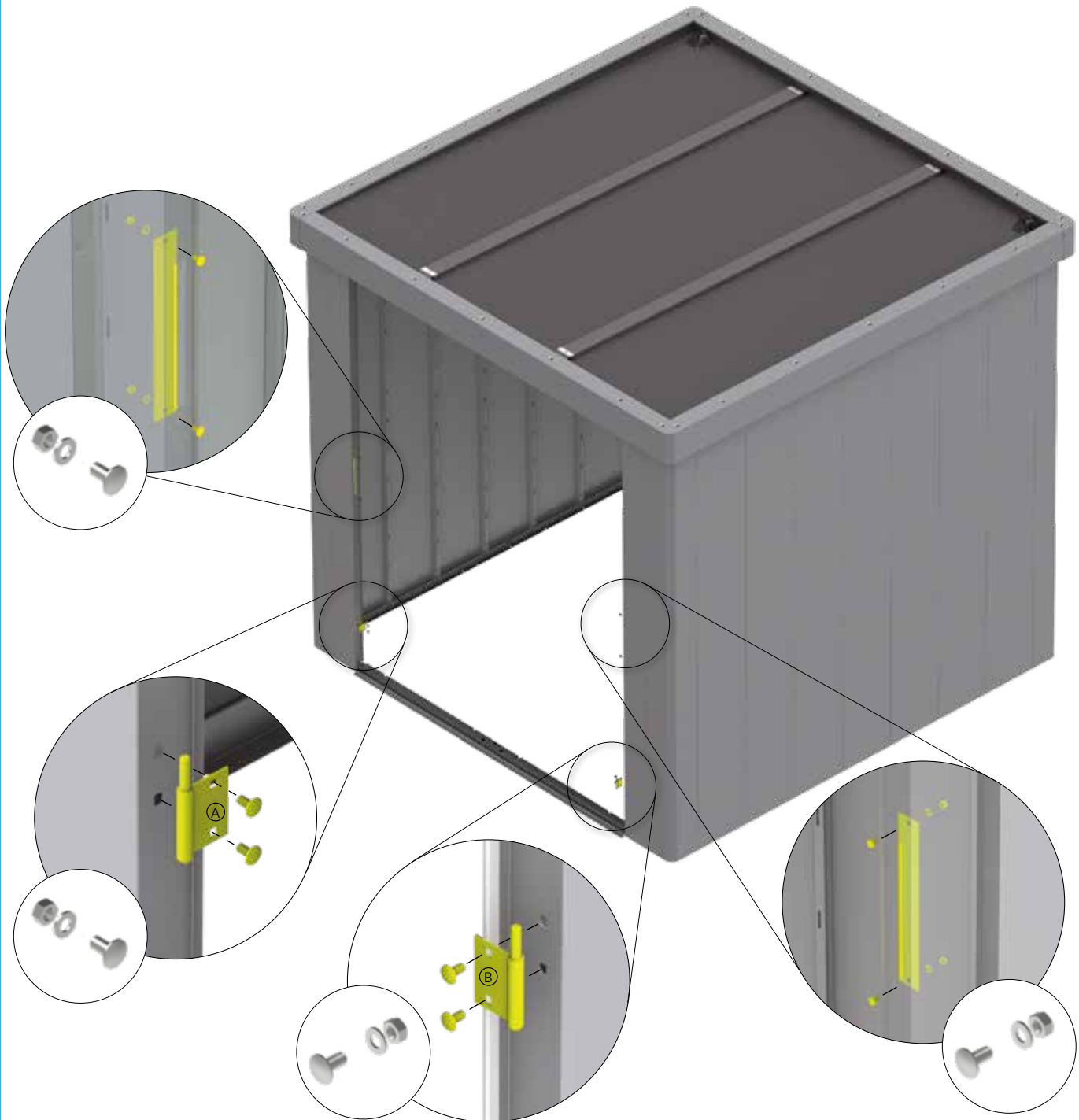



Doppeltür

Double Door - Deuxième battant de porte - Tweede deurvleugel - Secondo battente - Puerta doble - Dobbeldør - Dubbeldörr - Dobbelt dør - Podwójne drzwi - Dvojkřídlové dveře - Dvojna vrata - Dvoukřídlé dveře - Duplaajtó - Dvokrilna vrata

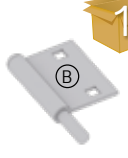
  	<p>1B: 2x 2B: 2x</p>	   	<p>1B: 1x 2B: 1x</p>	   	<p>1B: 1x 2B: 1x</p>
<p>M5 x 10</p>   	<p>1B: 8x 2B: 8x</p>				



41.

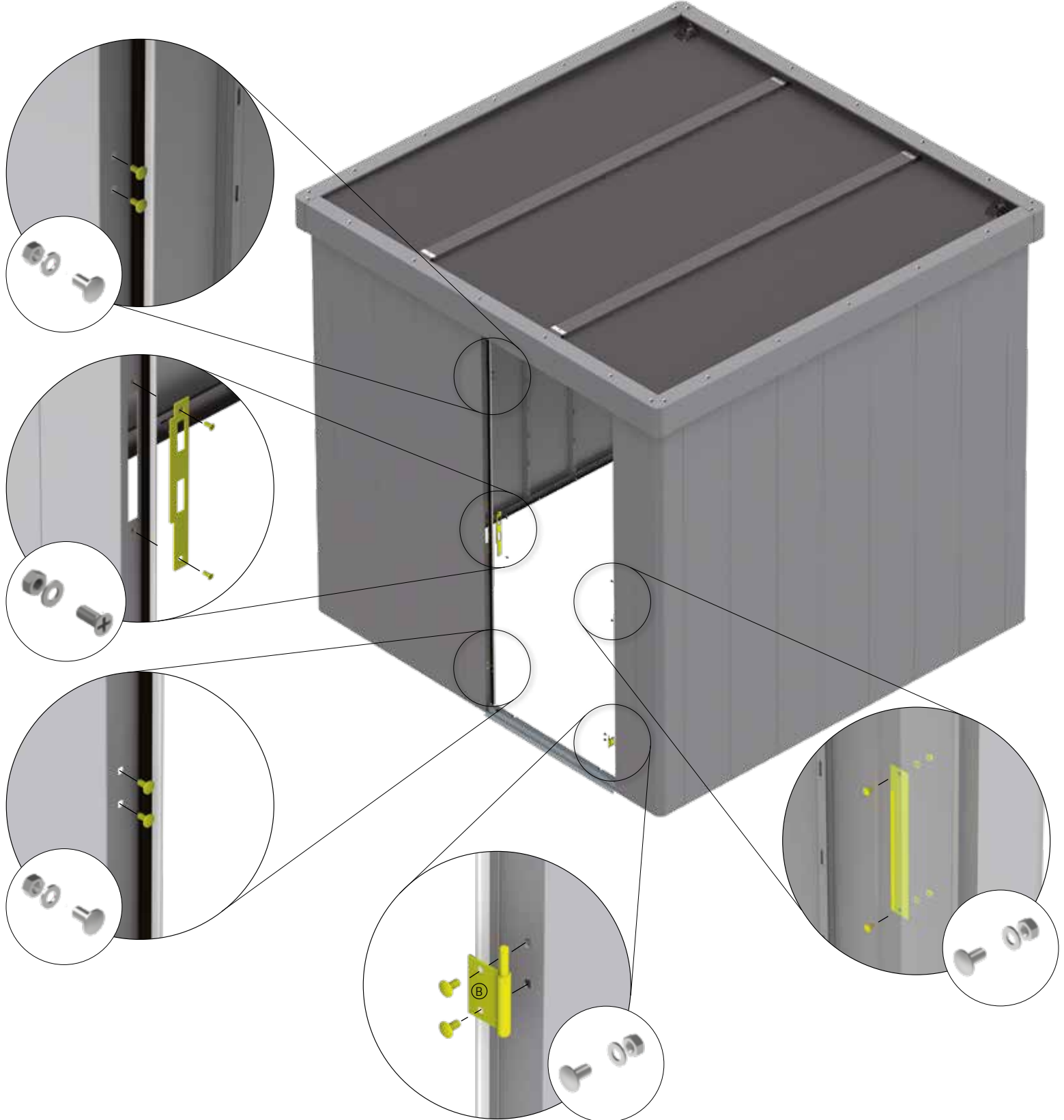

 <p>①</p>	 <p>1A: 1x 2A: 1x 1B: 1x 2B: 1x</p>	 <p>Ⓝ</p>	 <p>1A: 1x 2A: 1x 1B: 1x 2B: 1x</p>	 <p>Ⓟ</p>	 <p>1A: 1x 2A: 1x 1B: 1x 2B: 1x</p>
<p>M5 x 10</p>  <p>Ⓧ</p>	 <p>1A: 8x 2A: 8x 1B: 8x 2B: 8x</p>	<p>M5 x 12</p>  <p>Ⓧ</p>	 <p>1A: 2x 2A: 2x 1B: 2x 2B: 2x</p>		





Doppeltür

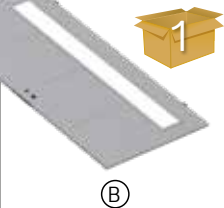
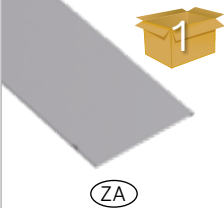
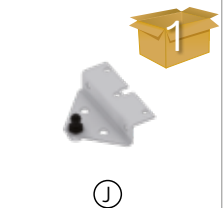
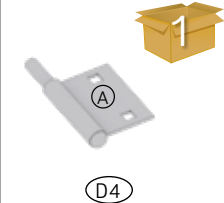
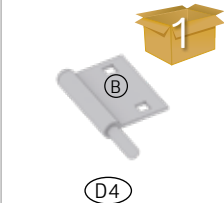

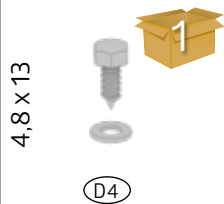
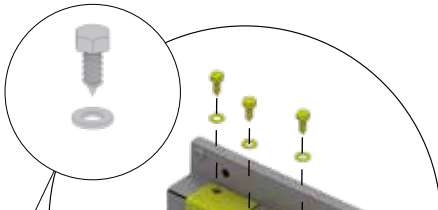
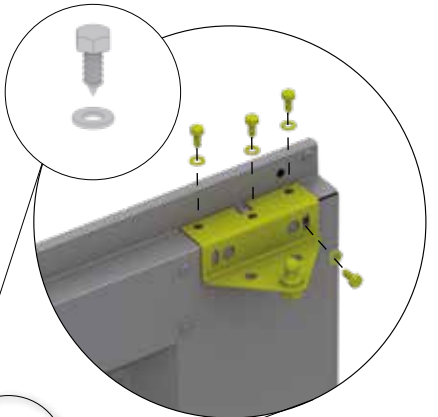



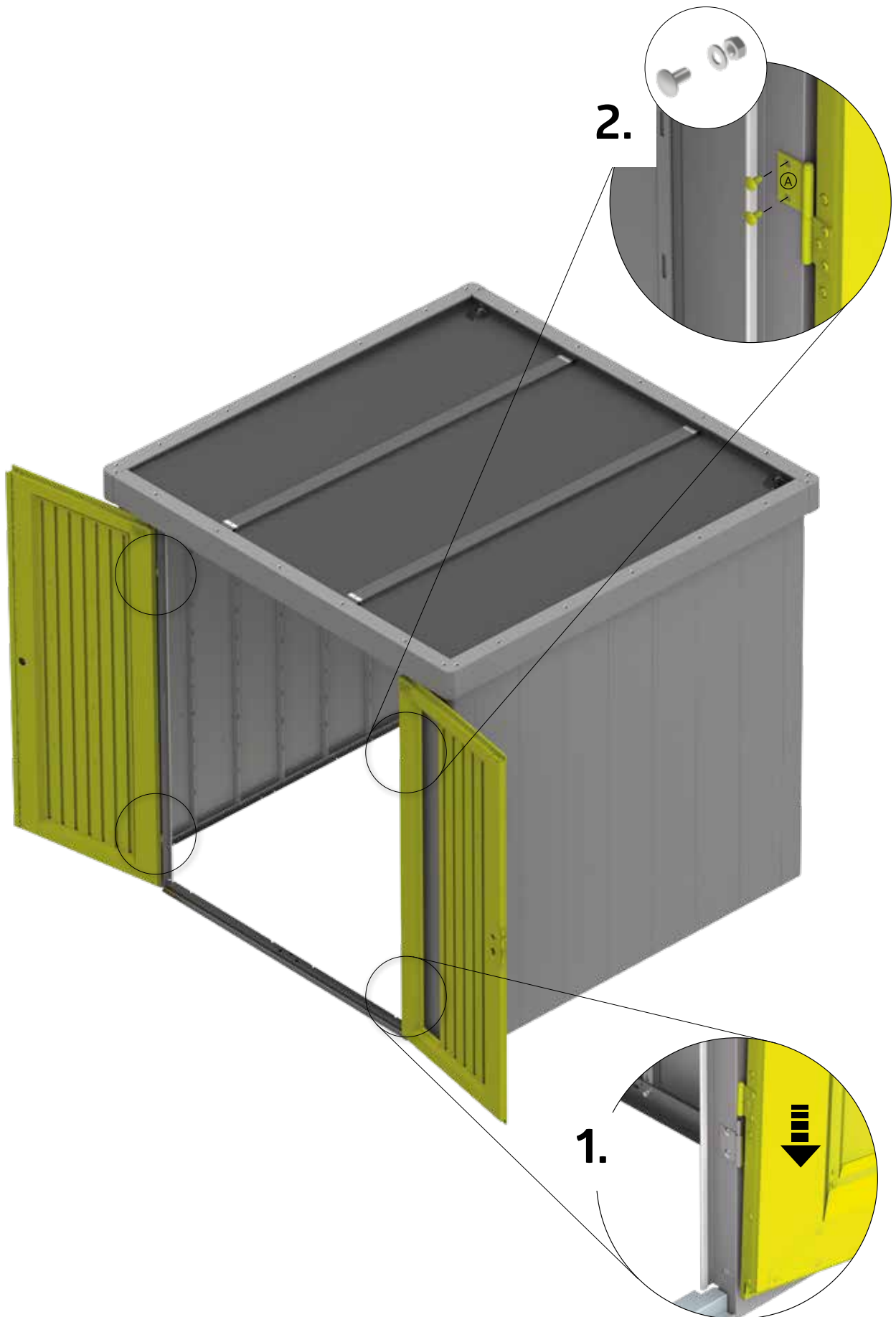

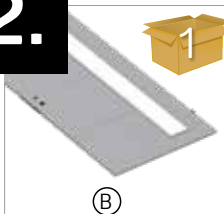

Double Door - Deuxième battant de porte - Tweede deurvleugel - Secondo battente - Puerta doble - Dobbeldør - Dub-beldörr - Dobbelt dør - Podwójne drzwi - Dvojkřídlové dveře - Dvojna vrata - Dvoukřídle dveře - Duplaajtó - Dvokrilna vrata

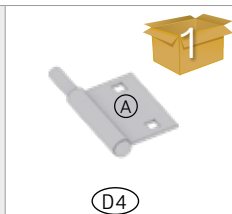
 1B: 1x 2B: 1x ⓑ	 1B: 1x 2B: 1x ⓐ	 1B: 2x 2B: 2x ⓙ
 1B: 1x 2B: 1x ⓐ	 1B: 1x 2B: 1x ⓑ	M5 x 10  1B: 4x 2B: 4x ⓓ4
4,8 x 13  1B: 8x 2B: 8x ⓓ4	 	





42.

 <p>(B)</p>	 <p>1A: 1x 2A: 1x 1B: 1x 2B: 1x</p>	 <p>(A)</p> <p>(D4)</p>	 <p>1A: 1x 2A: 1x 1B: 1x 2B: 1x</p>	 <p>(J)</p>	 <p>1A: 1x 2A: 1x 1B: 1x 2B: 1x</p>
<p>4,8 x 13</p>  <p>(D4)</p>	 <p>1A: 4x 2A: 4x 1B: 4x 2B: 4x</p>	<p>M5 x 10</p>  <p>(D4)</p>	 <p>1A: 2x 2A: 2x 1B: 2x 2B: 2x</p>		

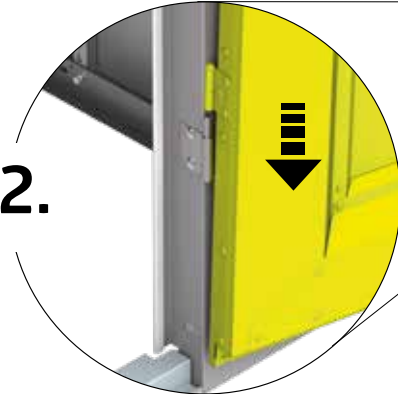
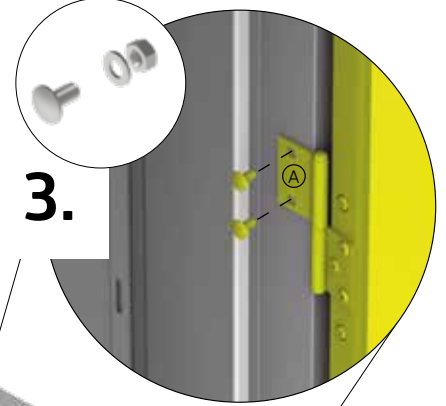
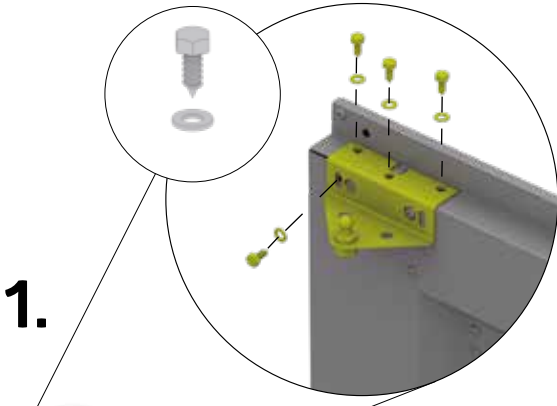

43.

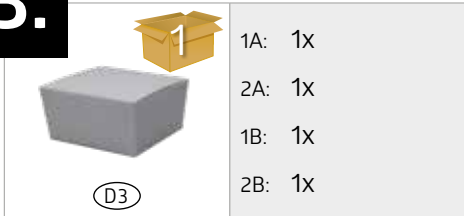

RESERVESCHLÜSSEL FÜR NACHFERTIGUNG SEPARAT AUFBEWAHREN!

- (GB)** Please keep a spare key separately in case you need to make copy!
- (FR)** Veuillez conserver vos clés de réserve séparément!
- (NL)** Reservesleutel a.u.b. apart bewaren. Dit i.v.m. eventuele nabestellingen!
- (ES)** Guarde una llave de repuesto separadamente por si tiene que encargar una copia!
- (IT)** Conservare la chiave di riserva in luogo sicuro per un' eventuale post-fabbricazione!
- (DK)** Gem reservnøglen separat, til hvis du skal lave en kopi!
- (SE)** Förvara reservnyckeln separat för reproduktion!
- (NO)** Oppbevar en reservnøkkel separat hvis du trenger å lage en kopi!
- (PL)** Przechowuj klucz rezerwowo osobno!
- (SK)** Prosím, uschovajte si náhradný kľúč pre možnosť zhotovenia kópie!
- (SI)** Prosimo, hranite ločeno rezervni ključ, če gab oste morali kopirati!
- (CZ)** A tartalék kulcsot tartsa külön helyen kulcsmásolás esetére!
- (HU)** Rezervni ključ čuvajte odvojeno u slučaju da trebate kopirati!
- (HR)** Rezervni ključ čuvajte odvojeno u slučaju da trebate kopirati!

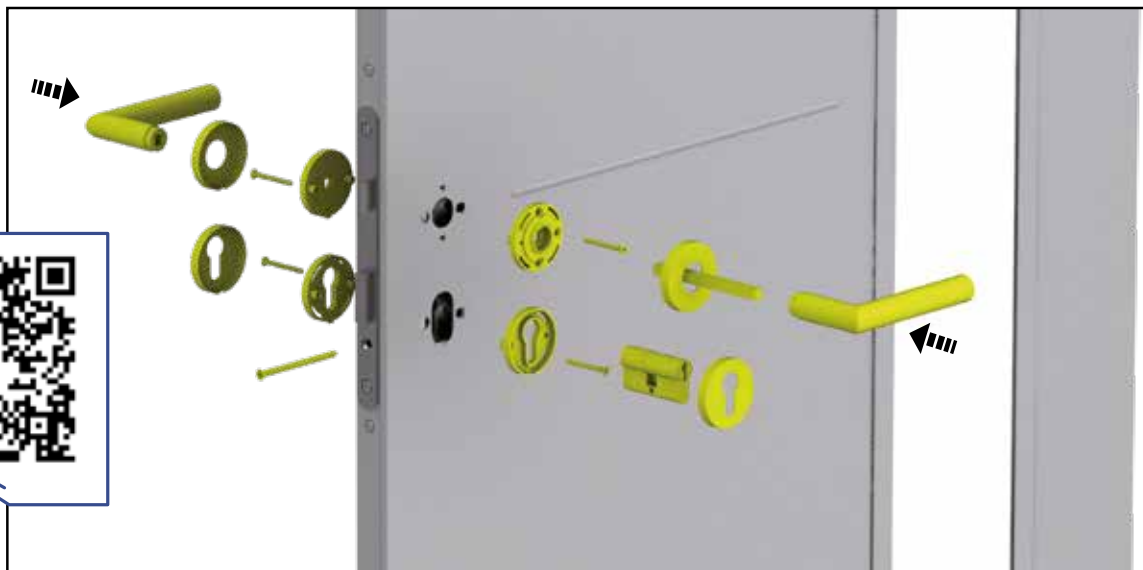

Zubehör - accessories - Accessoires - accessoires - Accesorios - accessori - tilbehør

Doppeltür

Double Door - Deuxième battant de porte - Tweede deurvleugel - Secondo battente - Puerta doble - Dobbeldør - Dubbeldörr - Dobbelt dør - Podwójne drzwi - Dvojkřídlové dveře - Dvojna vrata - Dvoukřídle dveře - Duplaajtó - Dvokrilna vrata

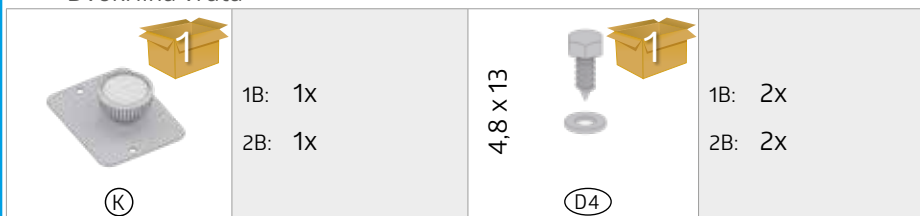

tilbehør- Tilbehør - akcesoria - příslušenstvo- Dodatki- Příslušenství- Tartozékok- dodaci

44.



- 1A: 1x
- 2A: 1x
- 1B: 1x
- 2B: 1x

OPTION Doppeltür

Double Door - Deuxième battant de porte - Tweede deurvleugel - Secondo battente - Puerta doble - Dobbeldør - Dubbeldörr - Dobbelt dør - Podwójne drzwi - Dvojkřídlové dveře - Dvojna vrata - Dvokřídlé dveře - Duplaajtó - Dvokrilna vrata



- 1B: 2x
- 2B: 2x

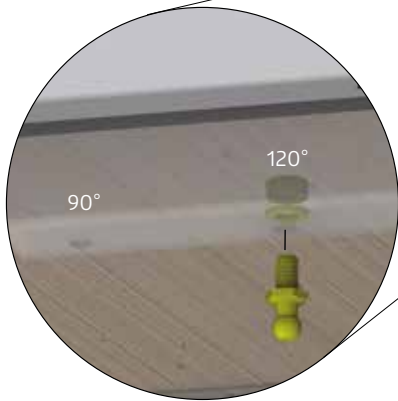
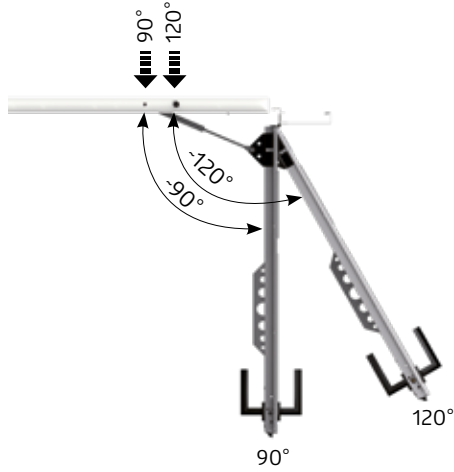

ZIEHEN SIE JETZT ALLE SCHRAUBVERBINDUNGEN FEST AN!

Tighten now all nuts and connections securely! - Serrez maintenant les vis à fond! - Draai nu alle schroeven vast! - Ahora puede apretar y fijar todos los tornillos y tuercas - Adesso serrare a fondo tutti i dadi - Fastspænd nu alle bolt-/skruerforbindelser! Dra nu át alla skruvförband ordentligt! - Stram nå alle muttere og tilkoblinger! - Teraz dokręć wszystkie śruby - Teraz utiahnite všetky spoje! - Zdaj varno privijte vse matice in povezave! - Nyní utáhněte všechny spoje! - Most húzza meg jól az összes csavart! - Sada čvrsto zategnite sve matice i spojeve!

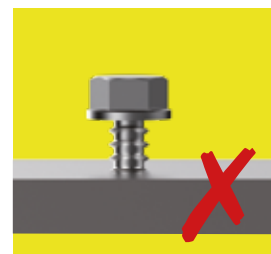
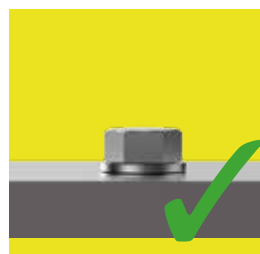

45.

TÜR EINRICHTEN

- Ⓒ GB Align the door
- Ⓒ FR Ajuster la porte
- Ⓒ NL Deur afstellen
- Ⓒ ES Ajuste la puerta
- Ⓒ IT Aggiustare la porta
- Ⓒ DK Justering af dør
- Ⓒ SE Justera dörren
- Ⓒ NO Juster døren
- Ⓒ PL Ustawić drzwi
- Ⓒ SK Porovnanie dverí
- Ⓒ SI Poravnajte vrata
- Ⓒ CZ Srovnání dveří
- Ⓒ HU Ajtó beállítás
- Ⓒ HR Poravnajte vrata

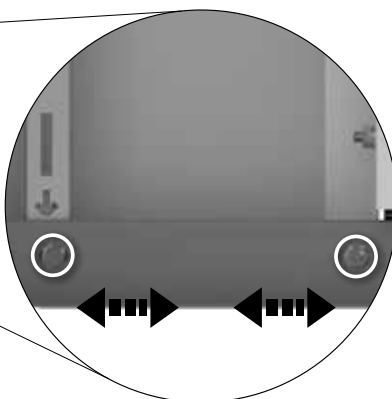
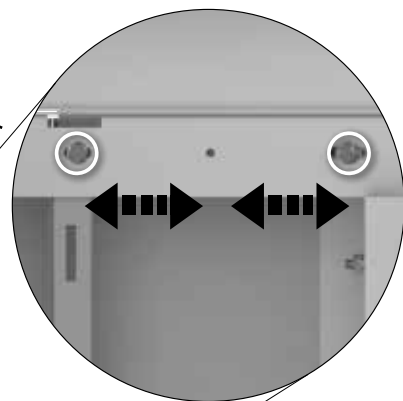
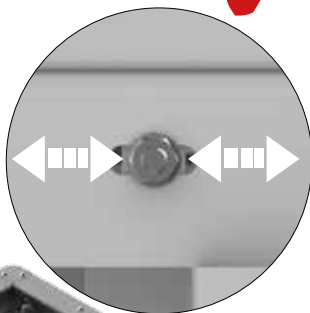
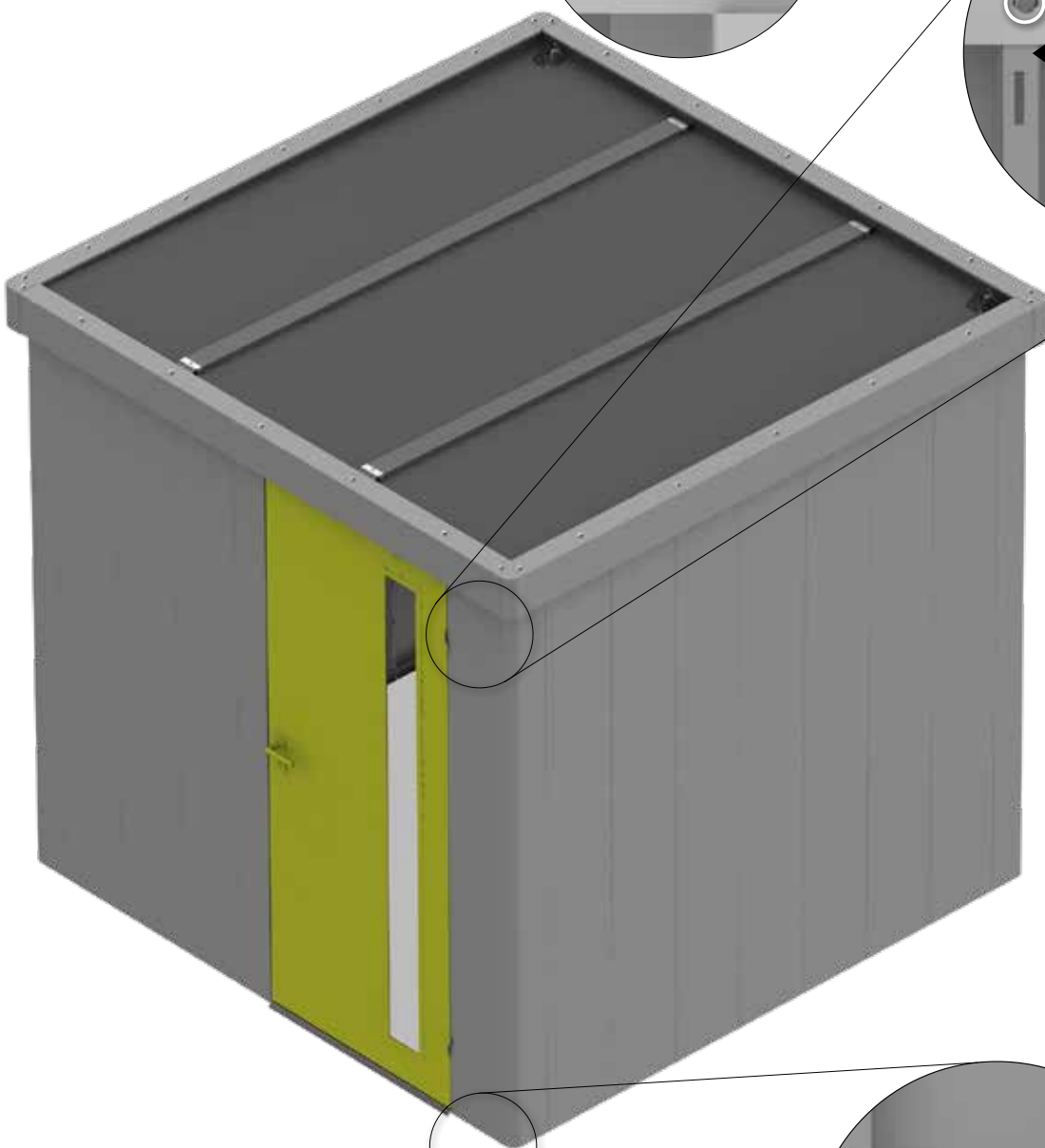
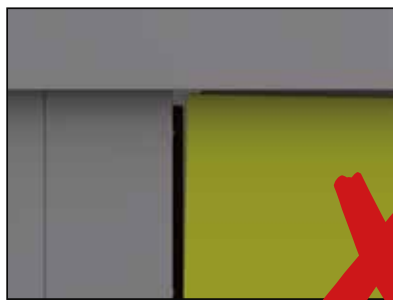

46.



(H)

1A: 1x
2A: 1x
1B: 1x
2B: 1x

OPTION Doppeltür

Double Door - Deuxième battant de porte - Tweede deurvleugel - Secondo battente - Puerta doble - Dobbeldør - Dubbeldörr - Dobbelt dør - Podwójne drzwi - Dvojkřídlové dveře - Dvojna vrata - Dvoukřídlé dveře - Duplaajtó - Dvokrilna vrata



(H)

1B: 2x
2B: 2x





Bodenrahmen

Floor frame - Cadre de sol - Bodemframe - Marco de suelo - Telaio perimetrale - Bundramme - Bottenram - Gulvramme - Rama podłogowa - Podlahový rám - Podlahový rám - Talni okvir · Padlókeret - Podni okvir



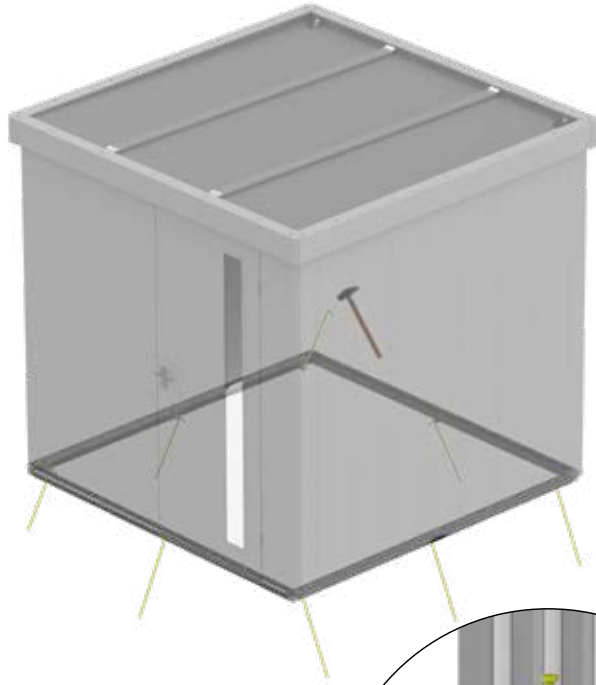
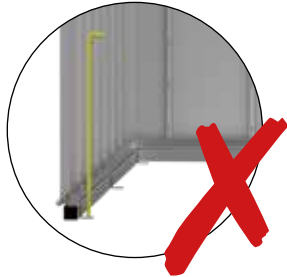
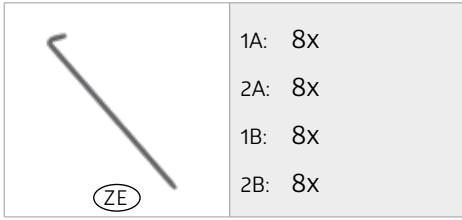

Variante 1, Proposal 1, Variant 1

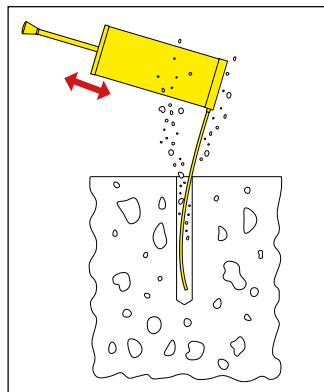
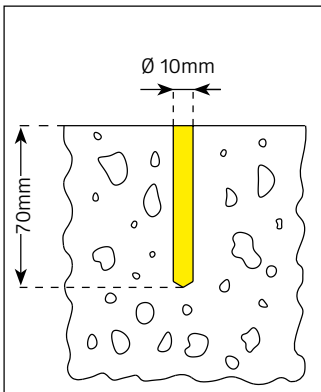
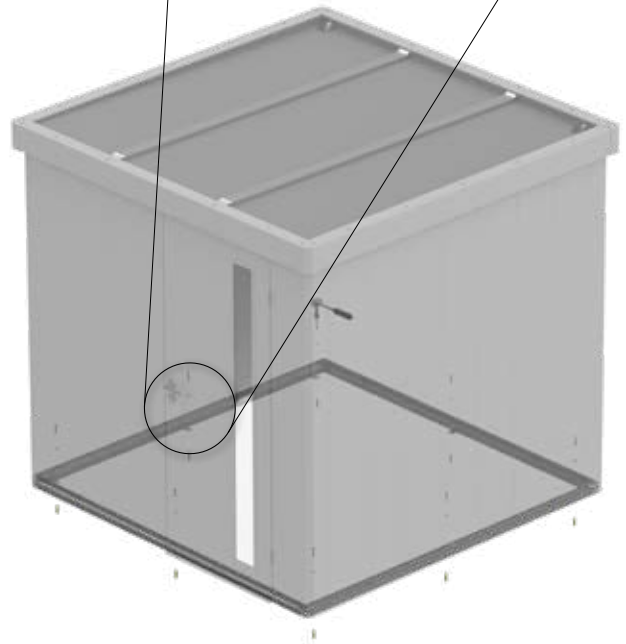
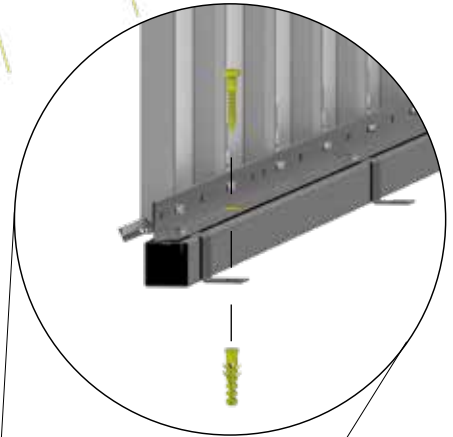
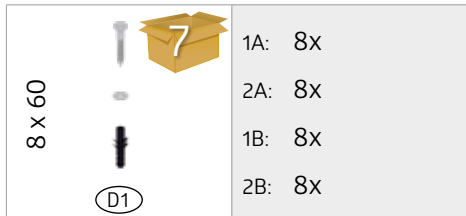



Variante 2, Proposal 2, Variant 2



47.

8 x 60		1A: 12x
		2A: 12x
		1B: 12x
		2B: 12x



 7

 D1

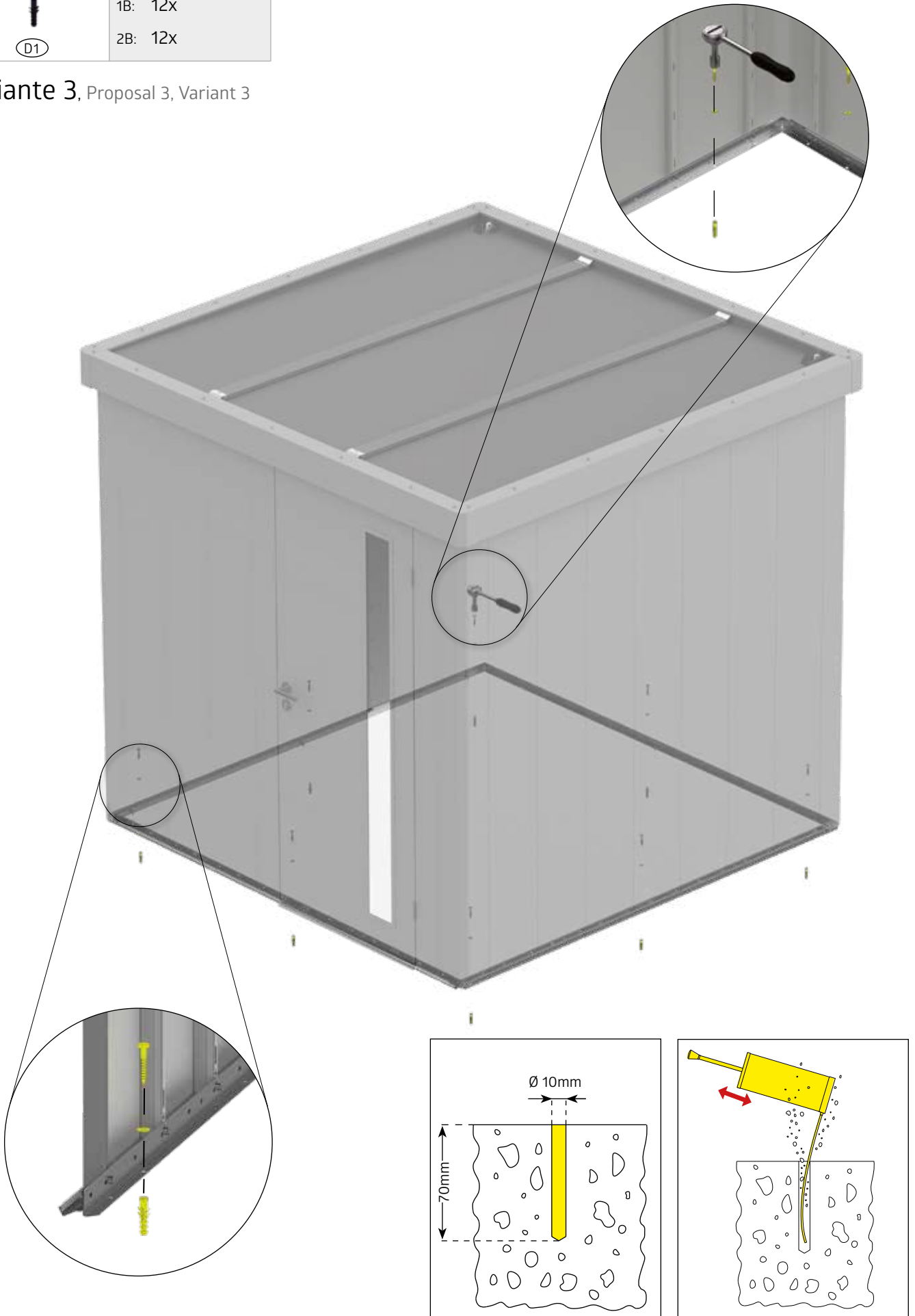
Variante 3, Proposal 3, Variant 3



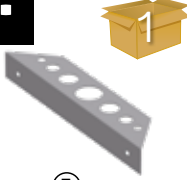

48.

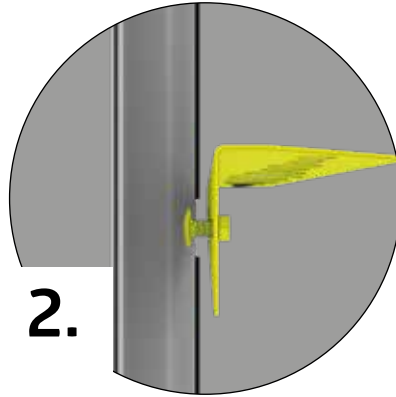
 Ⓔ	1A: 2X 2A: 2X 1B: 2X 2B: 2X	M5 x 10  Ⓓ4	1A: 4X 2A: 4X 1B: 4X 2B: 4X	 Ⓓ1	1A: 1X 2A: 1X 1B: 1X 2B: 1X
--	--------------------------------------	--	--------------------------------------	---	--------------------------------------



49.

	1A: 2x 2A: 2x 1B: 2x 2B: 2x		1A: 4x 2A: 4x 1B: 4x 2B: 4x
---	--------------------------------------	--	--------------------------------------

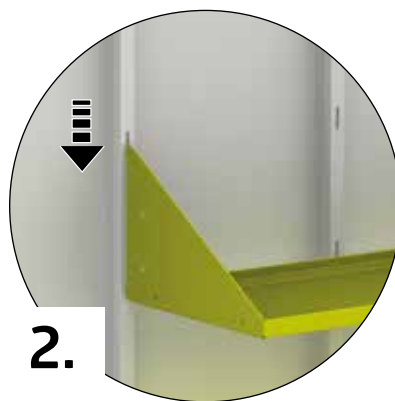
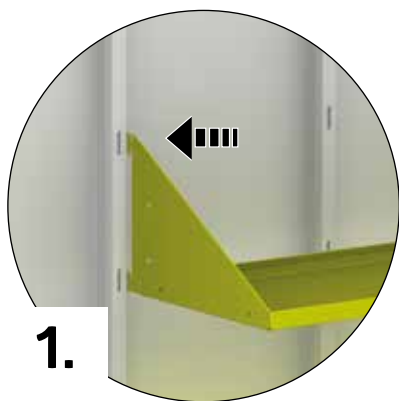

Option 1:



Option 2:

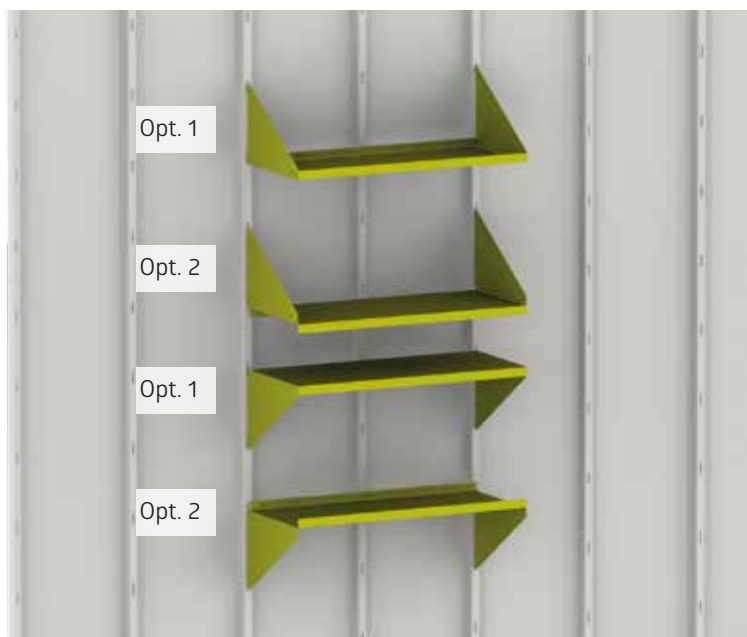
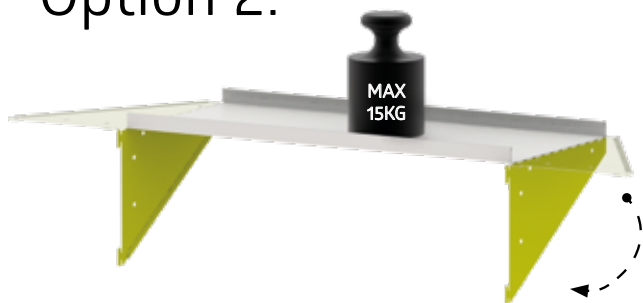

50.



(A1)

- 1A: 2X
- 2A: 2X
- 1B: 2X
- 2B: 2X

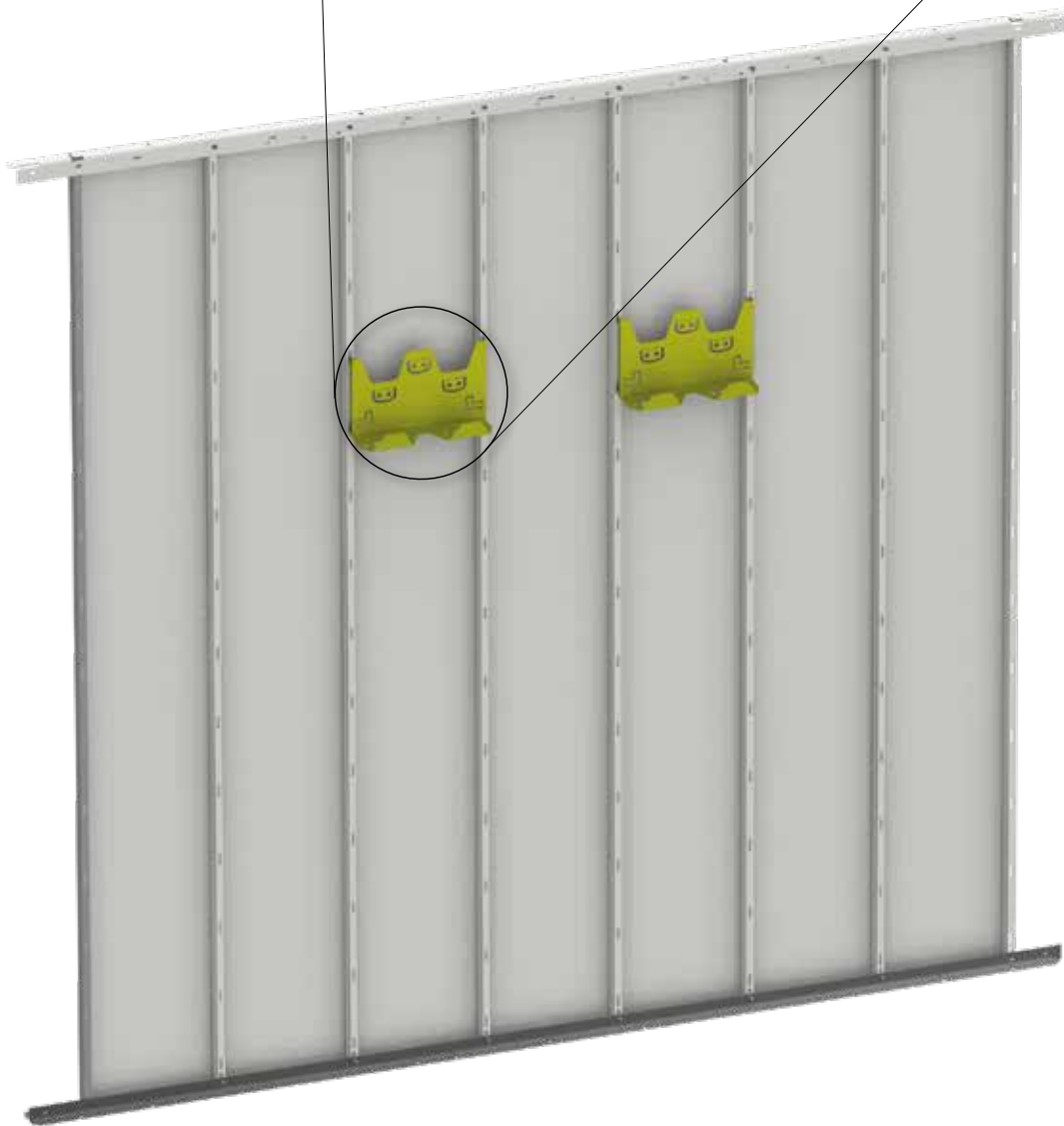
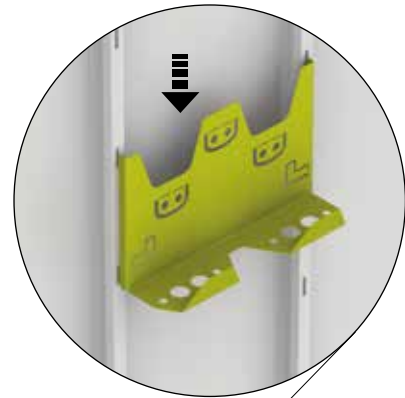
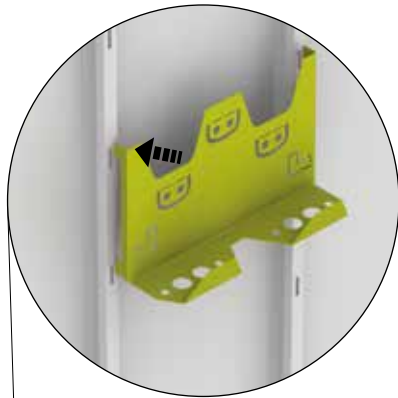

ABMESSUNGEN GERÄTEHAUS „NEO“

Dimensions garden shed "Neo"

Dimensions de la dépendance Neo

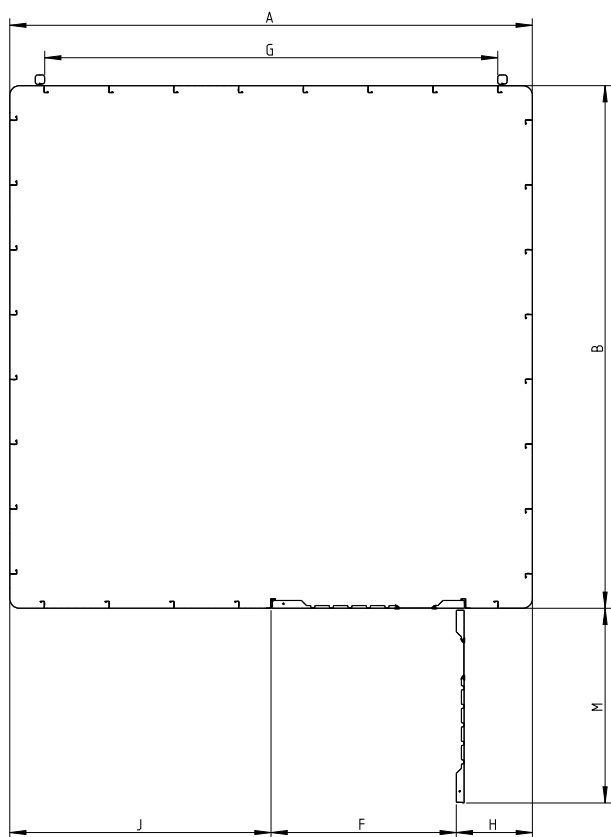
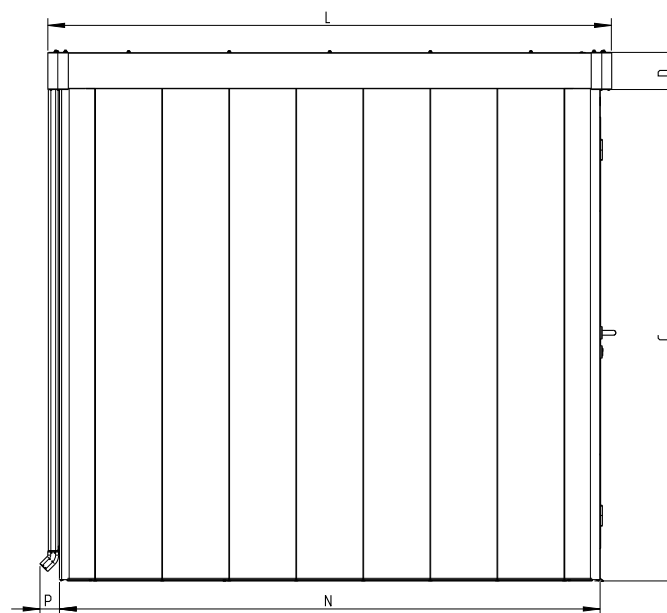
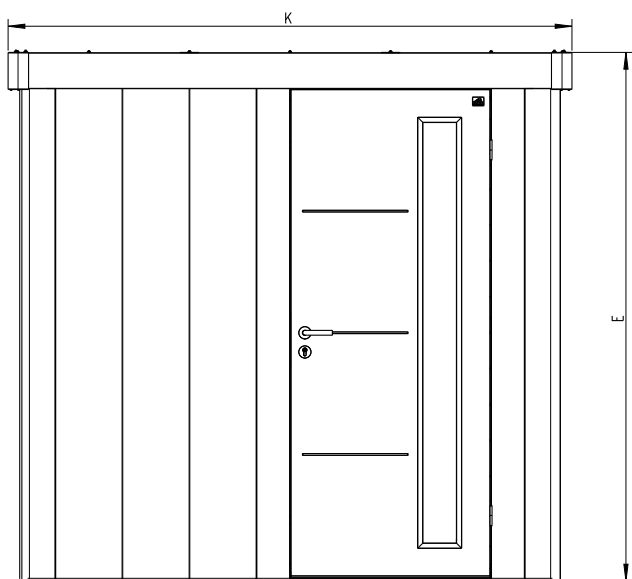

	NEO 1A	NEO 2A	NEO 1B	NEO 2B
A	1700 mm	1700 mm	2260 mm	2260 mm
B	1700 mm	2260 mm	1700 mm	2260 mm
C	2050 mm	2050 mm	2050 mm	2050 mm
D	155 mm	155 mm	155 mm	155 mm
E	2205 mm	2205 mm	2205 mm	2205 mm
F	800 mm	800 mm	800 mm	800 mm
G	1395 mm	1395 mm	1955 mm	1955 mm
H	330 mm	330 mm	330 mm	330 mm
J	570 mm	570 mm	1130 mm	1130 mm
K	1795 mm	1795 mm	2355 mm	2355 mm
L	1795 mm	2355 mm	1795 mm	2355 mm
M	840 mm	840 mm	840 mm	840 mm
N	1700 mm	2260 mm	1700 mm	2260 mm
P	80 mm	80 mm	80 mm	80 mm

EINREICHPLAN

für die Aufstellung eines Biohort-Gerätehauses Modell „Neo“

APPROVAL PLAN

for the erection of Biohort garden shed model "Neo"

DEMANDE

d'autorisation pour la mise en place d'un abri de jardin Biohort Modèle « Neo »

PLAN VAN GOEDKEURING

voor het bouwen van het Biohort tuinhuis model "Neo"

Adresse Aufstellort / Address at site of erection / Adresse du terrain / Platsingsadres

Grundbuch-Einlagezahl
Land register-Site No. / Cadastre
Katastralgemeinde

Grundstücks-Nr.
Property No. / Parcelle n°
Kadastraal nummer

Katastralgemeinde
Council/Borough responsible
Section/Commune / Eigendomsnummer

Bauwerber

Building applicant

Demandeur / Opbouwer

Vorname / Christian name / Prénom / Voornaam

Familienname / Surname / Nom / Achternaam

Anschrift / Address / Adresse / Adres

Unterschrift des Bauwerbers / Signature of applicant / Signature du demandeur / Handtekening eigenaar

Grundstückseigentümer

Property owner

Propriétaire du terrain

Landeigenaar

Vorname / Christian name / Prénom / Voornaam

Familienname / Surname / Nom / Achternaam

Anschrift / Address / Adresse / Adres

Unterschrift des Grundstückseigentümers / Signature of property owner
Signature du propriétaire / Handtekening eigenaar

Bodenfläche des Biohort-Gerätehauses:

Floorspace of biohort garden shed:

Surface au sol de l'abri de jardin Biohort :

Oppervlakte van het Biohort tuinhuis:

o Größe 1A / Size 1A / Taille 1A / Grootte 1A = 2,88 m²

o Größe 2A / Size 2A / Taille 2A / Grootte 2A = 3,83 m²

o Größe 1B / Size 1B / Taille 1B / Grootte 1B = 3,83 m²

o Größe 2B / Size 2B / Taille 2B / Grootte 2B = 5,09 m²

Gesamte bebaute Fläche

Total built-up area / Surface totale bâtie / Totaal bebouwde oppervlakte

Gartenfläche

Garden area / Surface du jardin / Tuin oppervlakte

Altbau bewilligt

Erection authorised by

Permis de construire du bâtiment existant sur le terrain N°

Opdracht tot opbouw door

vom

Date / En date du / Datum

Verein

Association / Société / Vereniging

Lageplan 1 : 500

Siteplan 1 : 500

Plan de masse 1 : 500

Map 1 : 500



GERÄTEHÄUSER – Setzen Sie auf Qualität & Langlebigkeit
GARDEN SHEDS – rely on quality & longevity



GARTENBOXEN – Outdoorboxen für Garten, Terrasse & Co.
OUTDOOR BOXES – outdoor boxes for garden, patio & more



FAHRRAD-GARAGEN – Fahrräder, Roller & Co sicher verstaut
BICYCLE STORAGE – for safe storage of bicycles, scooters & more



MÜLLTONNEN-BOXEN – Stylish, praktisch & wartungsfrei
DUSTBIN STORAGE – stylish, practical & maintenance free



GARTEN-HELFER – Gartendesign in Bestform
GARDENING HELPERS – garden design at its best



Adresses sur quefairedemesdechets.fr

Kontrollnummer:
 Control-number / Contrôle-Qualité / Controlnummer:



Bei Reklamationen bitte anführen:
 Kontrollnummer und Artikelnummer des reklamierten Teils.

GB: In case of complaint please indicate the control-number and the number of the item, which is subject of complaint.

F: Pour toutes réclamations: prière de joindre le numéro de contrôle et le numéro d'article de la pièce litigieuse.

NL: Bij reclamaties svp doorgeven: controlnummer en artikelnummer van het desbetreffende onderdeel.



Biohort steht für
 „LEBEN IM GARTEN“

Biohort stands for
 „LIFE IN THE GARDEN“

follow us:

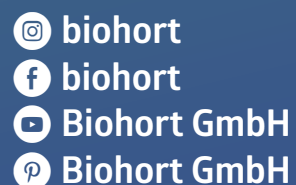

Biohort GmbH
 Pürnstal 43, 4120 Neufelden, Österreich
 Tel: +43-7282-7788-0
 E-Mail: office@biohort.at, www.biohort.com