

AUFBAUANLEITUNG

Geräteschrank Größe 90, 150, 190 und 230

- Ⓜ GB Assembly manual for equipment locker - size 90, 150, 190 and 230
- Ⓜ FR Notice de montage pour l'armoire à outils - taille 90, 150, 190 et 230
- Ⓜ NL Opbouwbeschrijving voor de Tuinkast - grootte 90, 150, 190 en 230
- Ⓜ ES Instrucciones de montaje del armario de jardín - tamaño 90, 150, 190 y 230
- Ⓜ IT Istruzioni di montaggio Armadio per attrezzi - misura 90, 150, 190 e 230
- Ⓜ DK Monteringsvejledning for Redskabsrum - størrelse 90, 150, 190 og 230
- Ⓜ SE Monteringsanvisning för Redskapskåp storlek 90, 150, 190, 230
- Ⓜ NO Monteringsanvisning for boden "Utstyrsskap" str 90, 150, 190 og 230
- Ⓜ PL Instrukcja montażu „Szafka narzędziowa” wielkości 90, 150, 190, 230
- Ⓜ SK Montážny návod pre „Skríňa na náradie” veľ. 90, 150, 190 a 230
- Ⓜ SI Priročnik za montažo „Omara za orodje” velikosti 90, 150, 190 in 230
- Ⓜ CZ Montážní návod pro „Skříň na náradí” velikost 90, 150, 190, 230
- Ⓜ HU Felépítési útmutató „Szerszámtároló” méretekre 90, 150, 190, 230
- Ⓜ HR Priručnik za montažu „Ormar za alat” veličine 90, 150, 190, 230
- Ⓜ RO Manual asamblare pentru Equipment Locker - marimile 90, 150, 190, 230

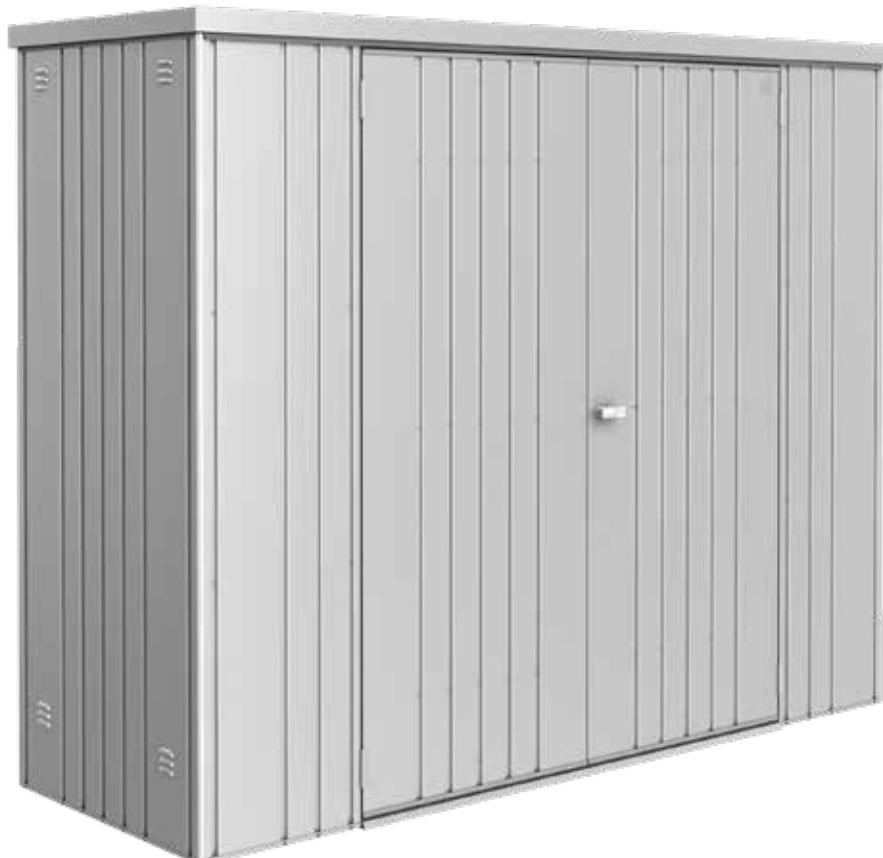

QUALITÄT AUS
ÖSTERREICH

WICHTIGE PUNKTE FÜR DEN AUFBAU!



VORLIEGENDE AUFBAUANLEITUNG ZEIGT DEN ZUSAMMENBAU VON „GERÄTESCHRANK“ GRÖSSE „230“; SIE GILT SINNGEMÄSS AUCH FÜR DIE GRÖSSE „90“, „150“ & „190“. FÜR EINIGE MONTAGESCHRITTE BENÖTIGEN SIE EINEN HELFER.

- GB** Important details regarding assembly! This assembly manual shows the erection of the "Equipment locker" size "230"; it is also valid for size "90", "150" & "190" For several assembly steps additional assistance of one person will be required.
- FR** Points importants lors du montage! Cette notice de montage décrit l'assemblage du produit « Armoire à outils » taille « 230 »; celle-ci est aussi valable pour la taille «90» «150» «190». Pour certaines étapes, demandez l'aide d'une personne.
- NL** Belangrijke punten voor de montage! Deze montage instructies hebben betrekking op de opbouw van de Tuinkast , grootte 230. De instructies zijn ook van toepassing op de grootte 90, 150 & 190. Voor enkele montage stappen heeft u 1 persoon nodig om u te helpen.
- ES** Notas importantes para el montaje: Estas instrucciones muestran el montaje del "Armario de jardín" en tamaño 230. También son válidas para el tamaño 90, 150 & 190. Es recomendable realizar el montaje con una otra persona.
- IT** Indicazioni importanti per il montaggio! Le seguenti istruzioni di montaggio fanno riferimento all'assemblaggio dell' "Armadio per attrezzi" misura "230"; per analogia sono valide anche per la misura "90", "150" & "190". Per alcune fasi di assemblaggio vi serviranno 1 aiutante.
- DK** Vigtige punkter ved samling! Samlemanualen viser opsætningen af modellen "Redskabsrum" str. "230"; gælder også for størrelse "90", "150" & "190". Ved flere punkter af opsætningen er yderligere hjælp påkrævet af 1 person.
- SE** Viktiga punkter för montering! Dessa monteringsanvisningar visar hur Redskapsskåp storlek 230 monteras. Anvisningarna gäller på motsvarande sätt för storlek 90, 150, 190. För vissa monteringssteg behöver du en medhjälpare.
- NO** Viktige punkter for montering! Denne monteringsanvisningen viser montering av boden "Utstyrsskap" størrelse "230"; den er også gyldig for størrelse "90", "150" og "190". Du trenger hjelp til noen av monteringsstrinnene.
- PL** Wskazówki dotyczące montażu. Niniejsza instrukcja wskazuje sposób montażu domku „Szafka narzędziowa” wielkość 230. Pozostałe wielkości - 90, 150, 190- analogicznie. Może być konieczna pomoc drugiej osoby.
- SK** Dôležité body pre montáž! Táto montážna príručka popisuje stavbu záhradného domčeka „Skriňa na náradie“ veľkosti „230“; platí aj pre veľkosť „90“, „150“ a „190“. Na niekoľko montážnych krokov budete potrebovať pomocníka.
- SI** Pomembne točke za montažo! Ta priročnik za montažo prikazuje postavitev vrtno lope model "Omara za orodje" velikosti "230"; velja tudi za velikosti "90", "150" in "190". Za nekatere korake sestavljanja boste potrebovali pomočnika.
- CZ** Důležité body pro montáž! Tyto montážní pokyny ukazují sestavení „Skříň na nářadí“ velikosti „230“; platí také pro velikosti "90, 150, 190". Pro některé kroky montáže budete potřebovat pomocníka.
- HU** Fontos információk az összeszereléshez! Ez a szerelési útmutató a "Szerszám tároló" 230 méretű ház összeszerelését mutatja; ez értelemszerűen a „90, 150, 190” méretekre is vonatkozik. Néhány összeszerelési lépéshez segítségre lesz szüksége.
- HR** Važne napomene za montažu! Ovaj priručnik za montažu prikazuje postavljanje vrtno kuće modela „Ormar za alat” veličine „230”; vrijedi i za veličine „90”, „150” i „190”. Za neke korake montaže će vam trebati pomoćnik.
- RO** Detalii importante pentru asamblare! Acest manual de asamblare arata montajul pentru "Equipment Locker" marime "230"; este valabil si pentru marimile "90", "150", "190". Pentru mai multi pasi de asamblare este necesara o persoana in plus pentru ajutor.

VERWENDEN SIE BEI DER MONTAGE ARBEITSHANDSCHUHE! UM KRATZER ZU VERMEIDEN, VERWENDEN SIE BITTE GEEIGNETE UNTERLAGEN!

- GB** Wear working gloves! Please use a suitable underlay to avoid scratches!
- FR** Portez des gants de travail! Pour éviter les rayures, utilisez les supports appropriés!
- NL** Handschoenen gebruiken! Om krassen te voorkomen raden wij u aan er iets onder te leggen!
- ES** Utilice unos guantes de trabajo. Por favor, coloque en el suelo una base protectora adecuada para evitar posibles arañazos.
- IT** Utilizzare guanti da lavoro. Utilizzare una base adatta per evitare graffi!
- DK** Brug arbejdshandsker! Benyt venligst et passende underlag for at undgå skrammer!
- SE** Använd arbetshandskar under monteringen! Använd lämpliga underlag för att undvika repor!
- NO** Bruk arbeidshansker! Bruk et passende underlag for å unngå riper!
- PL** Podczas montażu proszę używać rękawice ochronne. Chronić powierzchnię lakierowaną przed zarysowaniami.
- SK** Používajte pracovné rukavice! Prosím, použite vhodnú podložku, aby ste zabránili poškrábaniu!
- SI** Uporabite delovne rokavice! Uporabite ustrezno podlago, da se izognete praskam!
- CZ** Při montáži použijte pracovní rukavice! Použijte vhodné podložky, abyste se vyhnuli poškrábání!
- HU** Szerelésnél használjon védőkesztyűt! A karcolások elkerülése érdekében használjon megfelelő alátétetket!
- HR** Nosite radne rukavice! Upotrijebite odgovarajuće podlago, da se izognete praskam!
- RO** Purtati manusile de protectie! Va rog sa folositi o baza potrivita pentru a evita zgarieturile!



ACHTEN SIE AUF EINE STURMSICHERE BODENVERANKERUNG UND VERSPERREN SIE DIE TÜREN! NICHT BEI WIND AUFBAUEN!

- (GB)** Please make sure the product is anchored in a storm-proof manner and lock the doors! Do not assembly in windy condition!
- (FR)** Veillez à ce que le sol soit ancré de manière à résister aux tempêtes et verrouillez les portes! Ne pas procéder au montage dans des conditions venteuses !
- (NL)** Zorg voor een stormbestendige bodem verankering en vergrendel de deuren! Niet opbouwen in winderige omstandigheden!
- (ES)** Asegúrese de que el suelo cuente con un anclaje a prueba de tormentas y cierre las puertas. ¡No se instalen en condiciones de viento!
- (IT)** Assicuratevi che il pavimento sia ancorato a prova di tempesta e chiudete a chiave le porte! Non montare in condizioni di vento!
- (DK)** Vær opmærksom på at produktet forankres stormsikket samt at dør er aflåst! Bør ikke monteres ved kraftig vind!
- (SE)** Se till att markförankringen är stormsäker och lås dörrar! Genomför inte monteringen när det blåser!
- (NO)** Forsikre deg om at produktet er ordentlig forankret på en storm sikker måte og lås dørene! Ikke monter når det blåser mye!
- (PL)** Zwróć uwagę na wiatroodporne zakotwiczenie w ziemi i zamykaj drzwi! Nie montować przy silnym wietrze!
- (SK)** Dbajte na podlahové ukotvenie proti víchrici a zaistite dvere! Nerobte montáž pri vetre!
- (SI)** Prepričajte se, da je izdelek zasidran zaradi neviht in zaklepajte vrata! Ne sestavljajte v vetrovnem stanju!
- (CZ)** Zkontrolujte podlahové ukotvení odolné proti bouři a zamkněte dveře! Nenechávejte ve větru otevřené a nezajištěné!
- (HU)** Figyeljen a padló viharbiztos rögzítésére, valamint az ajtók és a tető zárhatóságára! Ne szélben építse fel!
- (HR)** Molimo osigurajte da je proizvod usidren na oluju i zaključajte vrata! Ne montirajte u vjetrovitom stanju!
- (RO)** Va rog sa va asigurati ca produsul este ancorat impotriva furtunii si incuiati usile! Nu asamblati in conditii de vant!



ACHTUNG: IM SOMMER KÖNNEN IM INNENRAUM SEHR HOHE TEMPERATUREN ENTSTEHEN!

- (GB)** Attention: during the summer high temperature might arise in the interior.
- (FR)** Attention: En été la température à l'intérieur de l'abri peut être élevée!
- (NL)** Let op: in de zomer kunnen in de berging zeer hoge temperaturen bereikt worden.
- (ES)** Tenga en cuenta que en el verano las temperaturas en el interior pueden ser altas.
- (IT)** I dadi devono essere serrati a fondo soltanto alla fine del montaggio!
- (DK)** Attention: Si prega di prendere nota che in estate si possono essere temperature molto elevate all'interno.
- (SE)** På sommaren kan mycket höga temperaturer uppstå inne i redskapsboden!
- (NO)** OBS: om sommeren kan det oppstå høy temperatur inne i produktet.
- (PL)** Uwaga: latem temperatura wewnątrz może wysoko wzrosnąć!
- (SK)** Pozor: v lete môže v interiéri dôjsť k zvýšeniu teploty.
- (SI)** Pozor: poleti se lahko v notranjosti pojavi visoka temperatura.
- (CZ)** Pozor: v létě může v interiéru dojít ke zvýšení teploty.
- (HU)** FIGYELEM: Nyáron a tárolók belsejében nagyon magas lehet a hőmérséklet!
- (HR)** Pažnja: tijekom ljeta u unutrašnjosti se može pojaviti visoka temperatura.
- (RO)** Atentie: in timpul verii in interior temperatura poate fi ridicata.

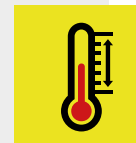

SCHRAUBVERBINDUNGEN GRUNDSÄTZLICH ERST AM ENDE DER MONTAGE FESTZIEHEN!

- (GB)** Nuts not to be tightened before the end of assembly!
- (FR)** Ne serrer les écrous à fond qu'à la fin du montage!
- (NL)** Schroeven pas aan het einde van de montage vastdraaien!
- (ES)** En principio, no apriete fijamente las tuercas hasta que no haya terminado de montar la caseta.
- (IT)** I dadi devono essere serrati a fondo soltanto alla fine del montaggio!
- (DK)** Møtrikkerne må ikke strammes før slutningen af opsætningen!
- (SE)** Dra alltid åt skruvförbanden först i slutet av monteringen!
- (NO)** Muttere som ikke skal strammes til før monteringen er ferdig!
- (PL)** Śruby dokręcić ostatecznie dopiero po zakończeniu montażu.
- (SK)** Matica dotahujte až pred koncom montáže!
- (SI)** Matic ne privijte pred koncem montaže!
- (CZ)** Matice dotahujte až před koncem montáže!
- (HU)** A csavarokat mindig csak az összeszerelés végén kell erősen meghúzni!
- (HR)** Matice ne treba stezati prije kraja montaže!
- (RO)** Piulitele nu trebuie stranse inainte de sfarsitul montajului!

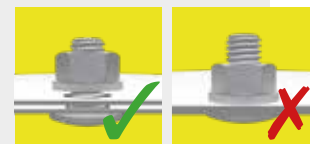

OPTIONALES ZUBEHÖR - SYMBOL!

Arbeitsschritte, die blau eingerahmt sind, zeigen den Einbau eines optionalen Zubehörteils.

- (GB)** Symbol of optional accessories: Blue framed assembly steps show the installation of optional accessories.
- (FR)** Accessoires en option-Symbole: La trame entourée en bleu indique une étape avec accessoires en option. A réaliser uniquement si vous avez commandé cet accessoire.
- (NL)** Extra Toebehoor: Montagestappen met een blauwe rand betreffen de inbouw van extra toebehoor.
- (ES)** Accesorio opcional – símbolo: Los pasos de montaje que se encuentran enmarcados en azul muestran el montaje de una pieza de un accesorio opcional.
- (IT)** Simbolo per accessori opzionali: Le fasi del montaggio incorniciate in colore azzurro mostrano l'installazione di un accessorio opzionale.
- (DK)** Symbol for ekstra udstyr: Blåt indrammet samletrin viser installationen af ekstraudstyr.
- (SE)** Symbol för extra tillbehör: Arbetssteg som är inramade i blått visar hur ett valfritt tillbehör installeras.
- (NO)** Symbol for tilleggsutstyr: Blå innrammede monteringsstrinn viser installasjonen av ekstrautstyr.
- (PL)** Wyposażenie dodatkowe - symbol: Czynności w niebieskiej ramce dotyczą elementów wyposażenia dodatkowego.
- (SK)** Symbol voliteľného príslušenstva: Montážne kroky v modrom rámečku ukazujú inštaláciu voliteľného príslušenstva.
- (SI)** Simbol dodatne opreme: Montažni koraki v modrem okvirju prikazujejo namestitve dodatne opreme.
- (CZ)** Symbol volitelného příslušenství: Montážní kroky v modrém rámečku ukazují instalaci volitelného příslušenství.
- (HU)** Opcionális tartozék – szimbólum: A kékek bekeretezett munkafolyamatok az opcionális tartozék beépítését jelölik.
- (HR)** Simbol dodatne opreme: Montažni koraci u plavom okviru ukazuju na ugradnju dodatne opreme.
- (RO)** Simbol accesorii optionale: Pasii de asamblare marcati cu albastru indica instalarea accesorilor optionale.



MASSTABSGETREUE ABBILDUNGEN DER ZU VERWENDENDEN SCHRAUBEN! (M 1:1)

- (GB)** Scale drawing 1:1 of the screws in use
- (FR)** Reproduction selon l'échelle 1:1.
- (NL)** Afbeelding : schaal 1:1 (ware grootte)
- (ES)** Reproducción a escala 1:1 de los tornillos que se utilizan para el montaje.
- (IT)** Immagine in scala delle viti da utilizzare!
- (DK)** Skala tegning af skruer er 1:1
- (SE)** Skalenliga ritningar av skruvarna som ska användas:
- (NO)** Måltegning 1: 1 av skruene som er i bruk
- (PL)** Skalowane ilustracje używanych śrub:
- (SK)** Mierka výkresu 1: 1 použitých skrutiek
- (SI)** Risba v merilu 1: 1 uporabljjenih vijakov
- (CZ)** Měřitko výkresu 1: 1 použitých šroubů
- (HU)** A felhasználandó csavarok méretarányos ábrái:
- (HR)** Crtež veličine 1: 1 vijaka koji se koriste
- (RO)** Scala desenului pentru suruburi este 1:1

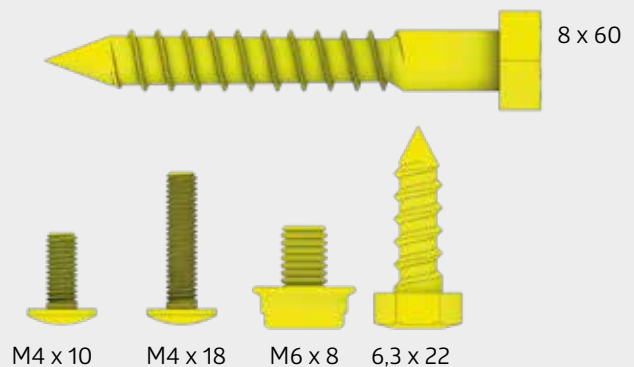

WASSERWAAGEN - SYMBOL!

Betreffendes Einbauteil mit der Wasserwaage ausrichten.

- (GB)** Symbol of spirit level: Align the respective parts by using the spirit level.
- (FR)** Symbole niveau à bulle: Lorsque ce symbole apparaît, vous devez ajuster l'élément à l'aide d'un niveau à bulle.
- (NL)** Waterpas – symbol: Bij montagestappen waar dit symbool bijstaat is het noodzakelijk het betreffende onderdeel waterpas in te bouwen.
- (ES)** Símbolo del nivelador: Indica que se debe ajustar y centrar la pieza con la ayuda de un nivelador.
- (IT)** Simbolo di livella a bolla d'aria: Allineare il componente in questione con l'ausilio di una livella a bolla d'aria.
- (DK)** Symbol for vaterpas: Juster de respektive dele ved hjælp af vaterpas.
- (SE)** Vattenpassymbol: Rikta in relevant installationsdel med vattenpasset.
- (NO)** Symbol på vater: Juster de respektive delene ved å bruke et vater.
- (PL)** Symbol poziomicy - element wypoziomować.
- (SK)** Symbol vodováhy: Vyrovnajte príslušnej časti pomocou vodováhy.
- (SI)** Simbol vodne tehtnice: Poravnajte ustrezne dele z uporabo vodne tehtnice.
- (CZ)** Symbol vodováhy: Vyrovnajte příslušné části pomocí vodováhy.
- (HU)** Vízmérték – szimbólum: A szükséges elem beállításához használjon vízmértéket.
- (HR)** Simbol libele: Poravnajte odgovarajuće dijelove pomoću libele.
- (RO)** Simbol nivela: Aliniați partile folosind nivela.

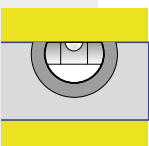

GRÖSSENABHÄNGIGER MONTAGESCHRITT!

Arbeitsschritte, die rot eingrahmt sind, zeigen den Zusammenbau eines größenabhängigen Montageschrittes.

- (GB)** Size-Dependent assembly step! Assembly steps that are framed in red show the assembly of a size-dependent assembly step
- (FR)** L'étape d'assemblage dépend de la taille de l'abri! Les étapes de montage encadrées en rouge sont des étapes de montage qui dépendent de la taille.
- (NL)** Montagesap afhankelijk van de grootte! In rood omkaderde montageschappen zijn niet voor alle maten van toepassing.
- (ES)** Paso de montaje dependiente del tamaño de la caseta! Los pasos de trabajo enmarcados en rojo muestran el montaje de un paso de montaje dependiente del tamaño.
- (IT)** Misura-dipendente fase di montaggio! Le fasi di lavoro incorniciate in rosso mostrano l'assemblaggio di una fase di assemblaggio dipendente dalle dimensioni.
- (DK)** Størrelses-afhængig montage skridt! Monteringsstrin, der er indrammet i rødt, viser samlingen af et størrelsesafhængigt samlingstrin
- (SE)** Storleksberoende monteringssteg! Monteringssteg som är inramade i rött visar monteringen av ett storleksberoende monteringssteg
- (NO)** Størrelsesavhengig monteringsstrinn! Monteringsstrinn som er innrammet i rødt viser monteringen av et størrelsesavhengig monteringsstrinn
- (PL)** Sposób montażu zależny od wielkości. Wskazówki, które są obramowane na czerwono, pokazują kroki montażowe w zależności od rozmiaru
- (SK)** Montážny krok závislý od veľkosti! Pracovný postup orámovaný červenou farbou znázorňuje montáž montážneho kroku závislého od veľkosti.
- (SI)** Korak montaže odvisen od velikosti! Koraki montaže, ki so uokvirjeni z rdečo barvo, prikazujejo sestavo koraka montaže, ki je odvisen od velikosti
- (CZ)** Montážní krok závislý na velikosti! Červené orámování znázorňuje sestavení montážního postupu v závislosti na velikosti.
- (HU)** Mérettől függő összeszerelési lépés! A piros kerettel ellátott munkalépések egy mérettől függő munkalépés elvégzését jelölik.
- (HR)** Korak sklopa ovisno o veličini! Koraci montaže koji su uokvirjeni crvenom bojom, prikazuju sastavljanje koraka montaže koji ovisi o veličini
- (RO)** Pas de asamblare în funcție de marimea produsului! Pasii de asamblare marcați cu roșu indică asamblarea anumitor componente în funcție de marimea produsului.



NAGEL - SYMBOL!

Bitte verwenden Sie den beiliegenden Nagel, um die Löcher der einzelnen Bleche auszurichten.

- (GB)** Symbol of nail: Please use the attached nail to align the holes of each sheet.
- (FR)** Symbole clou : veuillez utiliser le clou fourni pour aligner les trous sur chaque paroi.
- (NL)** Spijker-symbool: Bij montageschappen waar dit symbool bijstaat dient de spijker voor het laten corresponderen van 2 schroefgaten.
- (ES)** Símbolo del clavo: Utilice los clavos suministrados para alinear los orificios de cada chapa.
- (IT)** Simbolo del chiodo: Si prega di utilizzare il chiodo incluso per allineare i buchi di ogni lamiera.
- (DK)** Søm-symbol: Brug de medfølgende søm til at rette hullerne på de enkelte plader ind
- (SE)** Spiksymbol: Använd den medföljande spiken för att rikta in hålen i de enskilda plåtarna.
- (NO)** Symbol på spiker: Bruk den påsatte spikeren til å rette hullene på hvert plate.
- (PL)** Gwóźdź: Proszę użyć dołączonego gwoźdźca, aby wyrównać otwory poszczególnych arkuszy
- (SK)** Symbol klinca: Prosím, použite priložený klinec na vyrovnanie otvorov všetkých plechov.
- (SI)** Simbol žeblja: s pritrjenim žabljem poravnajte luknje na vsakem listu.
- (CZ)** Symbol hřebíku: Prosím, použijte přiložený hřebík k vyrovnaní otvorů všech plechů.
- (HU)** Szeg-szimbólu: Kérem, használja a mellékelt szöveget az egyes lemezek lyukainak kiigazításához
- (HR)** Simbol čavla: Pomoću priloženog čavla poravnajte rupe na svakom listu.
- (RO)** Simbol cui: Va rog sa folositi cuiul pentru alinierea orificiilor panourilor.



MONTAGESCHRITT ENTFÄLLT - SYMBOL!

Arbeitsschritt entfällt bei der im Symbol genannten Größe.

- (GB)** Symbol of assembly step not applicable: Assembly step is not applicable for the mentioned size in the symbol.
- (FR)** Étape de montage à supprimer - Symbole: Cette étape est supprimée selon la taille indiquée dans le symbole.
- (NL)** Montagesap vervalt - symbool: Montagesap vervalt bij de in het symbool genoemde grootte onderdeel waterpas in te bouwen.
- (ES)** Paso de montaje eliminado - Símbolo: Paso de trabajo eliminado en el tamaño indicado en el símbolo.
- (IT)** Questa fase di montaggio viene annullata - simbolo: Questa fase di lavoro viene annullata nella misura indicata con il simbolo.
- (DK)** Monteringskridtet ikke nødvendigt - symbolet: For arbejdsgangen falder bort for den størrelse, der vises med symbolet.
- (SE)** Symbol för uteblivet monteringssteg: Det här arbetssteget utgår för den storlek som anges i symbolen.
- (NO)** Symbol for monteringsstrinn ikke aktuelt: Monteringsstrinn gjelder ikke for den nevnte størrelsen i symbolet.
- (PL)** Nie dotyczy etapu montażu - symbol: Nie dotyczy etapu montażu podanego w symbolu
- (SK)** Montážne kroky sú vynechané - Symbol: Pracovný postup sa nevzťahuje na veľkosť zadanú v symbole.
- (SI)** Simbol koraka sestavljanja ni uporaben: korak sestavljanja ne velja za navedeno velikost simbola.
- (CZ)** Montážní kroky jsou vynechány - Symbol: Pracovní postup se nevztahuje na velikost zadanou v symbolu.
- (HU)** Összeszerelési lépés elmarad - szimbólum: Ez a lépés kimarad a szimbólumban megjelölt méreteknél.
- (HR)** Simbol koraka montaže nije primjenjiv: Korak montaže nije primjenjiv za spomenutu veličinu u simbolu.
- (RO)** Simbol pas de asamblare care nu se aplica: Pasul de asamblare nu se aplica pentru marimea mentionata in simbol.



PFLEGE UND WARTUNG!

Keine aggressiven Chemikalien wie z.B. Chlor oder Streusalz lagern!

Sonnenmilch und andere Cremes mit Wasser und Seife entfernen.

Keine scheuernden Reinigungsmittel verwenden!

Tiefe Kratzer sofort mit beiliegendem Lack ausbessern!

Ölen Sie das Schloss jährlich!

Schraubverbindungen regelmäßig kontrollieren!

- GB** Care and maintenance: Do not store aggressive substances i.e. chlorine or road salt! Remove suntan lotion or any other creams with soap and water! Do not use abrasive cleaning agents! Touch-up scratches immediately with the paint provided. Lubricate the lock once a year! Check screw connections regularly!
- FR** Entretien et maintenance: Ne pas stocker de produits chimiques (chlore, sel, etc...)! Nettoyez uniquement avec de l'eau les crèmes solaires et autres crèmes (pas de nettoyant chimique). Ne pas utiliser de produits nettoyant abrasifs! Corrigez immédiatement les rayures avec la laque jointe! Graissez la serrure et les charnières chaque année! Vérifiez régulièrement les raccords à vis!
- NL** Onderhoud: Geen chemicaliën in de berging opslaan! Zonnebrandolie/melk en andere cremes met water en glansmiddel verwijderen. Gebruik geen schuurmiddelen! Regelmatig bladeren van dak verwijderen! Krassen direct met de meegeleverde lak behandelen. Slot jaarlijks oliën. Controleer regelmatig de schroefverbindingen!
- ES** Cuidado y mantenimiento: No almacene productos químicos agresivos dentro de la caseta como por ejemplo cloro y sal antiescarcha. Evite dejar huellas o restos de cremas solares sobre la chapa. Limpie la caseta siempre con agua y jabón. No utilice ningún producto para fregar. En general, evite siempre cualquier producto químico para limpiar la caseta. Mantenga el tejado libre de hojas secas. Repare los arañazos lo antes posible con el barniz que se incluye. Aplique aceite en la cerradura y las bisagras una vez al año. ¡Compruebe las conexiones de los tornillos regularmente!
- IT** Manutenzione: Non lasciare prodotti chimici aggressivi (come ad esempio cloro o sale per strade) all'interno della casetta! Rimuovere crema solare e altre creme con acqua e brillantante! Non utilizzare detergenti contenenti sostanze aggressive! Mantenere il tetto libero da foglie! Ritoccare immediatamente eventuali graffi con la vernice fornita nella confezione! Lubrificare la serratura e le cerniere a cadenza annuale! Controllare regolarmente i collegamenti a vite!
- DK** Pleje og vedligeholdelse: Opbevar ikke aggressive stoffer dvs. Klor eller vejsalt! Fjern solcreme eller andre typer af creme med vand og rensningsmiddel! Brug ikke aggressive rengøringsmidler! Hold taget fri for blade! Ved skrammer, brug straks malingen som er stillet til rådighed! Smør låsen årligt! Kontroller skruesamlinger jævnligt!
- SE** Skötsel och underhåll: Förvara inga aggressiva kemikalier som klor eller vägsalt öppet! Ta bort solkräm och andra krämer med tvål och vatten. Använd inte slipande rengöringsmedel! Ta bort löv från taget regelbundet! Kontrollera avloppsrännan! Reparera omedelbart djupa repor med medföljande färg! Olja låset årligen! Kontrollera skruvanslutningarna regelbundet!
- NO** Stell og vedlikehold: ikke oppbevar aggressive stoffer, dvs. klor eller veisalt! Fjern solkrem eller andre kremer med vann og skyllemiddel! Ikke bruk slipende rengjøringsmidler! Hold taket fritt for blader! Lakk over riper umiddelbart med medfølgende lakkstift. Smør låsen en gang i året! Kontroller skruerforbindelsene regelmessig!
- PL** Pielęgnacja i konserwacja: Nie przechowywać chemikaliów jak związki chloru lub sól drogowa. Ewentualne zabrudzenia usuwać mydłem i wodą. Nie używaj ściernych środków czyszczących! Regularnie usuwaj liście z dachu! Natychmiast napraw głębokie zadrapania za pomocą dołączonej farby! Co roku smaruj zamek! Regularnie kontroluj dokręcenie śrub!
- SK** Starostlivosť a údržba: Neskladujte agresívne látky, napr. chlór alebo posypovú soľ! Opaľovací krém alebo iné krémy odstráňte vodou a leštidlom! Nepoužívajte abrazívne čistiace prostriedky! Udržujte strechu bez listia! Škrabance okamžite opravte priloženým opravným lakom. Raz ročne premažte zámky! Pravidelne kontrolujte skrutkové spoje!
- SI** Nega in vzdrževanje: Ne shranjujte agresivnih snovi, npr. Klor ali cestne soli! Losjon za sončenje ali druge kreme odstranite z vodo in sredstvom za izpiranje! Ne uporabljajte abrazivnih čistil! Na strehi naj ne bo listja! Prask se takoj dotaknite s priloženo barvo. Ključavnico namažite enkrat letno! Redno preverjajte vijačne povezave!
- CZ** Péče a údržba: Neskladujte agresivní látky, např. chlor nebo posypovou sůl! Opaľovací krém nebo jiné krémy odstráňte vodou a leštídem! Nepoužívejte abrazivní čisticí prostředky! Udržujte střechu bez listí! Škrábance okamžitě opravte přiloženým opravným lakem. Jednou ročně promažte zámky! Pravidelně kontrolujte šroubové spoje!
- HU** Ápolás és karbantartás: Ne tároljon semmiféle agresszív vegyszert, mint pl.: klórt vagy sót bontatlan állapotban! Távolítsa el a naptej és az egyéb krémeket víz és szappan használatával. Ne használjon súrolószereket! Rendszeresen távolítsa el a leveleket a tetőről! A mellékelt lakkal javítsa ki rögtön a mély karcolásokat! Évente olajozza be a zárat! Rendszeresen ellenőrizze a csavarokat!
- HR** Njega i održavanje: Ne skladištite agresivne tvari, tj. Klor ili cestovnu sol! Losion za sunčanje ili bilo koje druge kreme uklonite vodom i sredstvom za ispiranje! Ne koristite abrazivna sredstva za čišćenje! Krov ne ostavljajte bez lišća! Odmah dodirnite ogrebotine s priloženom bojom. Podmažite bravu jednom godišnje! Redovito provjeravajte vijčane spojeve!
- RO** Îngrijire și întreținere: Nu depozitați substanțe agresive, de exemplu cloruri sau substanțe saline! Îndepartați urmele de la cremele de protecție solară sau alte creme cu apă și săpun! Nu folosiți substanțe de curățare abrazive! Reparați zgărieturile cu kit-ul de vopsea de la noi. Aplicați ulei la incuietori o dată pe an! Verificați piulițele regulat!

UMGANG MIT BESCHÄDIGTEN TEILEN!

Verbauen Sie keine beschädigten Teile! Falls Sie Beschädigungen feststellen, müssen diese vorab inkl. aussagekräftiger Bilder an uns gemeldet werden. Durch den Verbau gelten die Teile als akzeptiert.

- (GB)** Handling of damaged parts: Do not install damaged parts! If you note damages, they must be reported to us in advance, including meaningful pictures. The parts are considered accepted by the installation.
- (FR)** Manipulation des pièces endommagées: N'installez pas de pièces endommagées! Si vous découvrez des dommages, vous devez nous en informer à l'avance, en nous envoyant des photos significatives. Après le montage, les pièces sont considérées comme acceptées.
- (NL)** Omgaan met beschadigde onderdelen: Monteer géén beschadigde onderdelen! Als u schade ontdekt, moet dit vooraf aan ons worden gemeld, inclusief duidelijke foto's. Als u de beschadigde onderdelen toch monteert, dan heeft u hiermee het product "geaccepteerd".
- (ES)** Manejo de partes dañadas: Por favor, NO instale partes dañadas, Si descubre algún daño, debe informarnos con antelación, incluyendo fotos claras de los daños. Las piezas se consideran aceptadas si se realiza su la instalación.
- (IT)** Gestione di parti danneggiate: Non installare parti danneggiate! Se si rivela un danno, questo deve essere segnalato in anticipo per mail con materiale fotografico a supporto del reclamo. Se si procede all'installazione delle parti danneggiate, Biohort si riserva il diritto di respingere il reclamo.
- (DK)** Håndtering af beskadigede dele: Brug ikke beskadigede dele! Hvis du opdager nogen skade, skal dette rapporteres til os på forhånd, herunder meningsfulde billeder. Dele betragtes som accepteret gennem installationen.
- (SE)** Hantering av skadade delar: Använd inte skadade delar! Om du upptäcker några skador måste detta rapporteras till oss i förväg, inklusive meningsfulla bilder. Delarna anses accepterade när de installeras.
- (NO)** Håndtering av ødelagte deler: Ikke monter ødelagte deler! Hvis du registrerer skader, må du rapportere dette til oss, og sende bilder av de skadde delene. Hvis skadde deler blir montert, anses de som akseptert av montøren.
- (PL)** POSTĘPOWANIE Z USZKODZONYMI CZĘŚCIAMI Nie używaj uszkodzonych części! W przypadku stwierdzenia jakichkolwiek uszkodzeń należy je zgłosić wraz ze szczegółowymi zdjęciami. Elementy uszkodzone zainstalowane uważane są za zaakceptowane.
- (SK)** Zaochádzanie s poškodenými dielmi: V prípade že zistíte nejaké poškodenia, musia nám byť tieto nahlásené aj s príslušnými fotografiami. V prípade zabudovania budú diely považované za akceptované.
- (SI)** Ravnanje s poškodovanimi deli: Poškodovanih delov ne nameščajte! Če opazite škodo, nam je to treba sporočiti vnaprej, vključno s slikami. Namestitvev šteje, kot da so deli sprejeti.
- (CZ)** Manipulace s poškozenými částmi: Pokud zjistíte poškození, musíte nám to nahlásit předem, včetně průkazných obrázků. Díly jsou považovány za přijaté jejich instalací.
- (HU)** A sérült alkatrészek kezelése: Ha bármilyen sérülést észlel, a sérült elemeket képekel igazolva jeleni kell felénk. A beépítéssel, az elemeket elfogadottnak tekintjük.
- (HR)** Rukovanje oštećenim dijelovima: Nemojte postavljati oštećene dijelove! Ako primijetite štetu, morate nam je prijaviti unaprijed, uključujući značajne slike. Instalacija smatra da su dijelovi prihvaćeni.
- (RO)** Manipularea pieselor deteriorate: Nu instalati piesele deteriorate! Dacă observati deteriorari, trebuie sa ne anuntati inainte de asamblare, impreuna cu fotografii clare. Dacă le asamblati se considera acceptate.

HALTEN SIE WÄHREND DES ZUSAMMENBAUS ALLE MITGELIEFERTEN KLEINTEILE ODER VERPACKUNGSMATERIALIEN FERN VON KLEINKINDERN!

Bauteile weisen scharfe Kanten auf oder stehen vor, achten Sie während der Montage und bei der täglichen Nutzung darauf.

- (GB)** Keep all supplied small parts or packaging materials away from small children during assembly. Components have sharp edges or protrude, pay attention to them during assembly and during daily use.
- (FR)** Gardez toutes les petites pièces ou les matériaux d'emballage fournis hors de portée des enfants pendant le montage. Les pièces d'assemblage peuvent être tranchantes, faites-y attention lors de l'assemblage et de l'utilisation quotidienne.
- (NL)** Houd alle kleine onderdelen of verpakkingsmaterialen die worden mee geleverd uit de buurt van kleine kinderen tijdens de montage. Onderdelen hebben scherpe randen of steken uit, let op bij de montage en bij het dagelijks gebruik.
- (ES)** Mantenga todas las piezas pequeñas o materiales de embalaje suministrados lejos de los niños durante el montaje. Los componentes tienen bordes afilados o salientes, preste atención a ellos durante el montaje y durante el uso diario.
- (IT)** Tenere tutte le piccole parti o i materiali d'imballaggio forniti lontano dalla portata dei bambini durante il montaggio. I componenti hanno spigoli vivi o sporgenti, prestare attenzione ad essi durante il montaggio e durante l'uso quotidiano.
- (DK)** Hold alle leverede smådele og emballage utilgængeligt for børn under montagen. Komponenter har skarpe kanter eller stikker ud, vær opmærksom på dem under montering og under daglig brug.
- (SE)** Håll alla medföljande smådelar och förpackningsmaterial borta från småbarn under monteringen. Komponenterna kan ha vassa kanter eller utstickande delar, var uppmärksam på detta vid montering och daglig användning.
- (NO)** OBS: Hold alle smådeler og emballasjemateriale borte fra små barn under montering. Komponentene har skarpe kanter eller noe som stikker ut, vær oppmerksom på dette under monteringen og under den daglig bruken.
- (PL)** ZACHOWAJ WSZYSTKIE MAŁE CZĘŚCI PODCZAS MONTAŻU LUB MATERIAŁY OPAKOWANIA Z DALA OD MAŁYCH DZIECI. Elementy mają ostre lub wystające krawędzie, należy zwracać na to uwagę podczas montażu i codziennego użytkowania.
- (SK)** Udržujte počas montáže všetky dodané malé diely a obalové materiály mimo dosahu malých detí. Komponenty majú ostré hrany alebo vyčnievajúce časti. Dbajte na to počas montáže a každodenného používania.
- (SI)** POZOR: Med montažo naj bodo vsi dobavljeni majhni deli ali embalažni materiali oddaljeni od majhnih otrok. Sestavni deli imajo ostre robove ali pa štrlijo, bodite pozorni nanje med sestavljanjem in med vsakodnevno uporabo.
- (CZ)** Během montáže udržujte všechny malé dodávané díly nebo obalové materiály mimo dosah malých dětí. Díly mají ostré hrany nebo vyčnívají, věnujte jim pozornost při montáži a každodenním používání, aby nedošlo k úrazu.
- (HU)** Az összeszerelés során kisgyerekektől tartsa távol az apró alkatrészeket valamint a csomagolóanyagokat. A szerelés és a napi használat során ügyeljen az éles szélékre valamint a kiálló részekre.
- (HR)** PAŽNJA: Tijekom montaže držite sve isporučene male dijelove ili materijale za pakiranje podalje od male djece. Sastavni dijelovi imaju oštre robove ili štrše, obratite pažnju na njih tijekom montaže i tijekom svakodnevnog uporabe.
- (RO)** Nu lasati piesele mici sau ambalajul la indemana copiilor. Componentele au margini taioase sau inteapa, aveti grija in timpul asamblării si in timpul folosirii zilnice.

VORSCHLÄGE FÜR DAS FUNDAMENT!

Bitte achten Sie bei der Fundamentgestaltung darauf, dass Niederschlagswasser nicht seitlich unter den Bodenprofilen in das Gerätehaus eindringen kann! Aufsteigende Bodenfeuchtigkeit und Kondensation vermeiden Sie mittels einer starken Kunststoffolie unter dem Fundament.

- GB** Proposals for a secure foundation: When making the foundation arrangements please take necessary precaution to ensure that water cannot leak in under the floor profiles. Rising ground moisture and condensation can be avoided by using a strong plastic sheet underneath the paving slabs or underneath the concrete foundation.
- FR** Conseils pour les fondations: Lors de la réalisation de la fondation, veillez à ce que l'eau de pluie ne puisse pas pénétrer dans l'abri ou par les côtés sous les profils de sol. Vous pouvez éviter l'humidité du sol et la condensation en mettant un film plastique épais sous les plaques de béton.
- NL** Voorstellen voor fundament : Let er bij het maken van de fundering op dat regenwater niet onder het bodemprofiel kan doorlopen. Een vochtige bodem en condensatie kunt u vermijden door het aanbrengen van een sterke kunststoffolie onder de tegels of het betonfundament.
- ES** Medidas y recomendaciones para los cimientos: Al colocar los cimientos, asegúrese de que el agua de lluvia no puede penetrar en la caseta por los laterales debajo del perfil del suelo. Evite la humedad y la condensación en el suelo colocando una lámina de plástico bajo las losas o los cimientos de hormigón.
- IT** Proposte per il basamento: Il basamento deve essere progettato in modo da evitare infiltrazioni di acqua piovana all'interno della casetta. Un telo di plastica spesso posto in corrispondenza dell'area di pavimento evita infiltrazioni di umidità dal terreno e la formazione di condensa.
- DK** Forslag til sikkert fundament: Ved etablering af fundament skal du tage de nødvendige forholdsregler for at sikre, at vand ikke kan sive ind under gulvprofilerne. Stigende fugt og kondens i jorden kan undgås ved at bruge plastik under flisebelægningen eller under betonfundamentet.
- SE** Förslag för fundamentet: Se till att regnvatten inte kan tränga in i redskapsboden från sidan under golvprofilerna när du utformar fundamentet! Du kan undvika stigande markfuktighet och kondens genom att placera en kraftig plastfilm under fundamentet.
- NO** Forslag til ett sikkert fundament: Når du lager fundamentet, må du ta nødvendige forholdsregler for å sikre at vann ikke kan lekke inn under gulvprofilene. Økende fuktighet og kondens på bakken kan unngås ved å bruke en sterk plastduk under belegningsplatene eller under betongfundamentet.
- PL** Uwagi dot. Fundamentu: Przy projektowaniu fundamentu należy zwrócić uwagę, aby woda opadowa nie przedostawała się do wnętrza pod profilami podłogowymi! Stosować izolację z folii z tworzywa sztucznego.
- SK** Návrhy pre bezpečný základ: Pri príprave základov prosím vykonajte potrebné opatrenia, aby ste zabezpečili, že pod podlahovými profilmi nebude môcť presakovať voda. Stúpajúci zemnej vlhkosti a kondenzácii možno zabrániť použitím silného plastového plechu pod dlažobnými doskami alebo pod betónovým základom.
- SI** Predlogi za varne temelje: Pri pripravi temeljev upoštevajte ustrezne previdnostne ukrepe, da zagotovite, da voda ne more uhajati pod talnimi profili. Naraščajoči vlagi in kondenzaciji tal se lahko izognemo z uporabo močne plastične folije pod tlakovci ali pod betonskim temeljem.
- CZ** Návrhy pro bezpečný základ: Při přípravě základů prosím proveďte nezbytná opatření, abyste zajistili, že pod podlahovými profily nebude moci prosakovat voda. Stoupající zemní vlhkosti a kondenzaci lze zabránit použitím silného plastového plechu pod dlažebními deskami nebo pod betonovým základem.
- HU** Javaslatok az alapzathoz: Az alapzat elhelyezésekor kérem, ügyeljen arra, hogy az esővíz ne juthasson be a padlóprofilok alatt a szerszámtárolóba!! Elkerülheti az emelkedő talajnedvességet és páralecsapódást úgy, hogy egy erős műanyag fóliát helyez az alapzatra.
- HR** Prijedlozi za siguran temelj: Prilikom izrade temelja, poduzmite potrebne mjere predostrožnosti kako biste osigurali da voda ne može procuriti ispod podnih profila. Povećana vlaga i kondenzacija u tlu mogu se izbjeći upotrebom jakog plastičnog lima ispod pločica za popločavanje ili ispod betonskog temelja.
- RO** Sugestii pentru o fundatie sigura: Cand analizati optiunile pentru fundatie va rog sa va asigurati ca apa nu se infiltreaza sub podeaua casutei. Umiditatea si condensul pot fi evitate daca utilizati o folie sub pavaj sau sub fundatia de beton.

FUNDAMENTDETAILS!

Weitere Details betreffend Fundament finden Sie auch unter www.biohort.com/Fundament

- GB** Further details about foundations you will find at www.biohort.com/foundation
- FR** Pour des détails supplémentaires, veuillez consulter www.biohort.com/foundations
- NL** Verdere details over het fundament vindt u ook op www.biohort.com/fundament
- ES** Encuentre información detallada sobre los cimientos en: www.biohort.com > servicios > cimientos
- IT** Per ulteriori dettagli si prega di consultare www.biohort.com/it/servizi/suggerimenti-per-le-fondamenta
- DK** Yderligere informationer om fundamentet finder du på www.biohort.com/foundation
- SE** Mer information om fundamentet hittar du även på www.biohort.com/se/service/fundamenttips
- NO** Ytterligere informasjon om fundament finner du på www.biohort.com/foundation
- PL** Więcej informacji n.t. montażu fundamentów na stronie: www.biohort.com/Fundament
- SK** Ďalšie informácie o základoch nájdete na www.biohort.com/foundation
- SI** Nadaljnje podrobnosti o temeljih najdete na www.biohort.com/foundation
- CZ** Další informace o základech najdete na www.biohort.com/foundation
- HU** Az alapzathoz szakséges további részletek a www.biohort.com/hu/szerviz/alapzat-oetletek oldalon találhatóak.
- HR** Dodatne detalje o zakladama naći ćete na www.biohort.com/foundation
- RO** Mai multe detalii despre fundatie gasiti la www.biohort.com/fundatie

SMARTBASE



SMARTBASE^{PLUS}



BETONFUNDAMENT

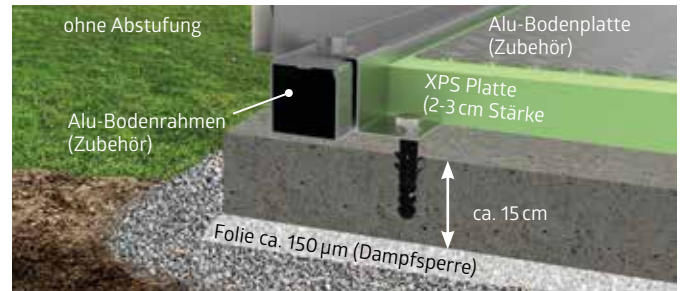

PUNKTFUNDAMENT

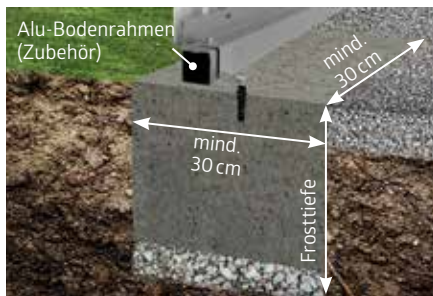

GEHWEGPLATTEN

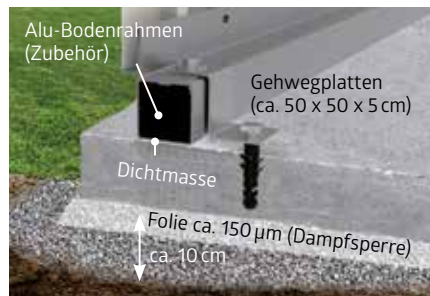

BODENRAHMEN

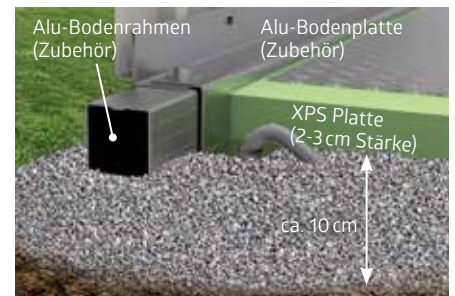

ABMESSUNGEN FÜR DAS FUNDAMENT!

- (GB)** Foundation dimensions:
- (FR)** Dimensions pour la fondation:
- (NL)** Maat voor het fundament:
- (ES)** Medidas de los cimientos:
- (IT)** Dimensioni del basamento:
- (DK)** Fundament dimensioner:
- (SE)** Fundamentets mått:
- (NO)** Fundament dimensjoner:
- (PL)** Wymiary fundamentu:
- (SK)** Rozměry základov:
- (SI)** Dimenzije temelja:
- (CZ)** Rozměry základů:
- (HU)** Alapzathoz szükséges méretek:
- (HR)** Dimenzije temelja:
- (RO)** Dimensiunile fundatiei:

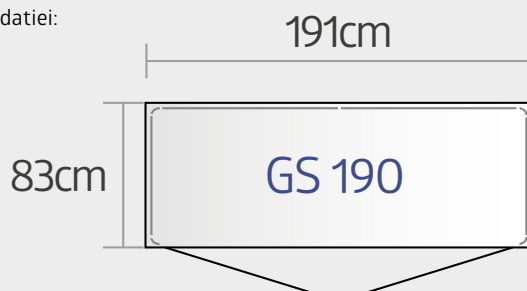
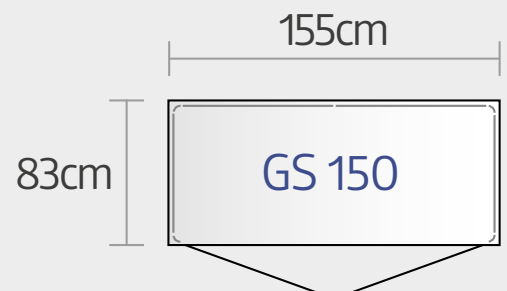
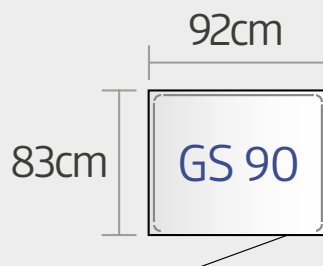

BODENRAHMEN - OPTIONALES ZUBEHÖR

Floor frame · Cadre de sol · Bodemframe · Marco de suelo · Telaio perimetrale · Bundramme · Bottenram · Gulvramme · Rama podłogowa · Podlahový rám · Rama podłogowa · Talni okvir · Padlókeret · Podni okvir · Rama podea

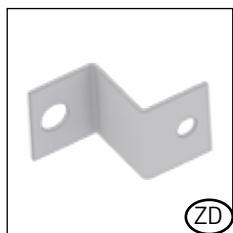

GERÄTESCHRANK 90

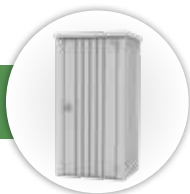

TEILEÜBERSICHT

Parts list · Liste des pièces · Stuklijst · Lista de piezas · Lista de parti · Deloversigt · Delöversikt · Del liste · Przegląd elementów · Zoznam dielov · Seznam delov · Seznam dílů · Tételék áttekintése · Popis dijelova · Lista pieselor

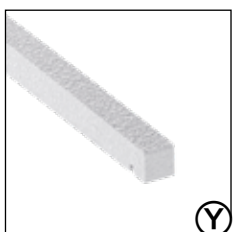
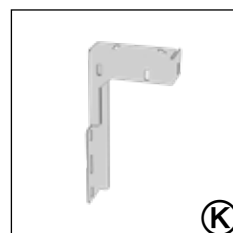
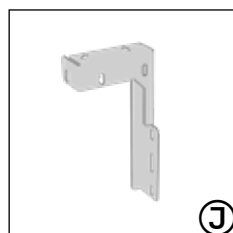
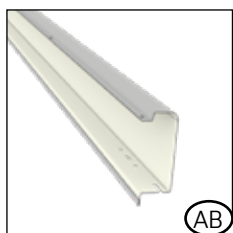
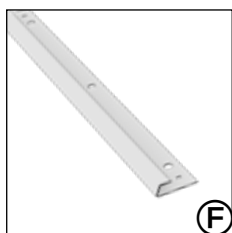
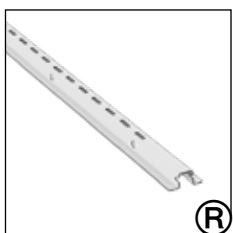
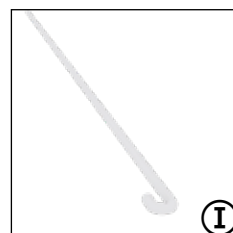
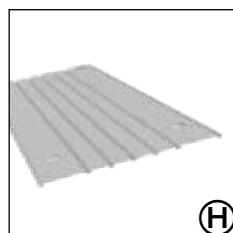
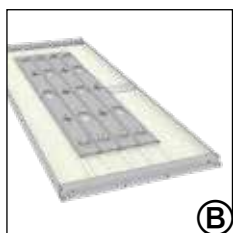
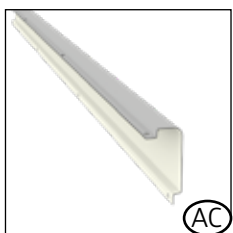
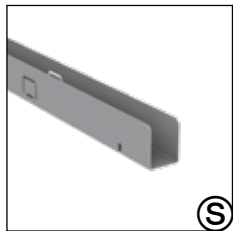
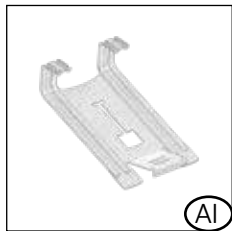
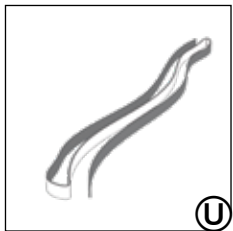
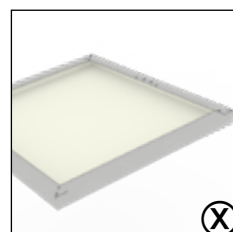
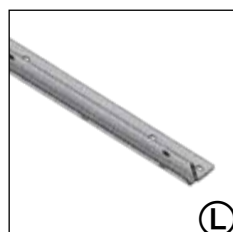
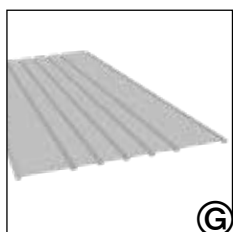
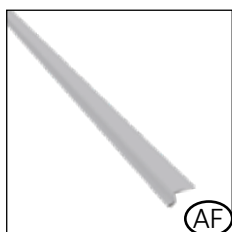
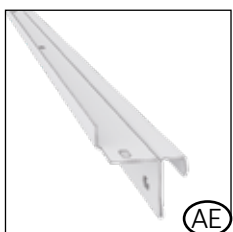

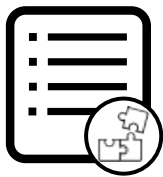

TEILEÜBERSICHT

Parts list · Liste des pièces · Stuklijst · Lista de piezas · Lista de parti · Deloversigt · Delöversikt · Del liste · Przegląd elementów · Zoznam dielov · Seznam delov · Seznam dílů · Tétélek áttekintése · Popis dijelova · Lista pieselor



DACH - PROFILPAKET

Roof profile package · Carton de profils de toit · Dakprofielpakket · Kit de perfiles de tejado · Pacco profili del tetto · Tagprofielpakke · Takprofielpaket · takprofil pakke · opakowanie zawierające profile dachowe · Balenie strešných profilov · Paket strešnih profilov · Balení střešních profilů · Tetőprofil csomag · Paket krovnih profila · Pachet profile acoperis

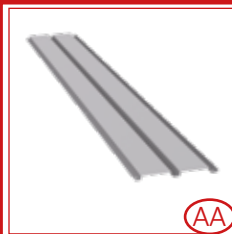
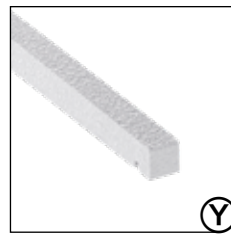
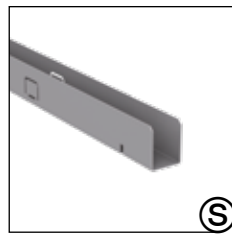
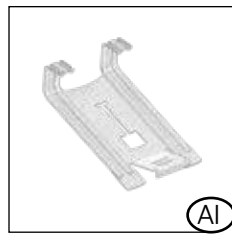
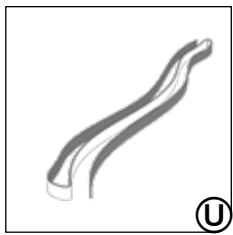
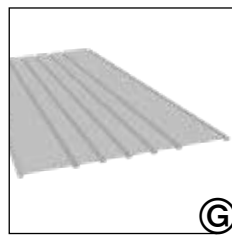
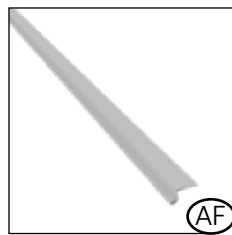
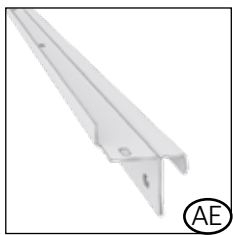

NUR FÜR GRÖSSE 190

- GB** Only for size 190
- FR** Uniquement pour taille 190
- NL** Alleen voor maat 190
- ES** Sólo para el tamaño 190
- IT** Solo per misura 190
- DK** Kun for størrelse 190
- SE** Endast för storlek 190
- NO** Bare til str 190
- PL** Czynność tylko dla wielkości 190
- SK** Len pre veľ. 190
- SI** Samo za velikosti 190
- CZ** Pouze pro vel. 190
- HU** Csak 190-es mérethez
- HR** Samo za veličine 190
- RO** Doar pentru latimea 190



NUR FÜR GRÖSSE 230

- GB** Only for size 230
- FR** Uniquement pour taille 230
- NL** Alleen voor maat 230
- ES** Sólo para el tamaño 230
- IT** Solo per misura 230
- DK** Kun for størrelse 230
- SE** Endast för storlek 230
- NO** Bare til str 230
- PL** Czynność tylko dla wielkości 230
- SK** Len pre veľ. 230
- SI** Samo za velikosti 230
- CZ** Pouze pro vel. 230
- HU** Csak 230-es mérethez
- HR** Samo za veličine 230
- RO** Doar pentru latimea 230





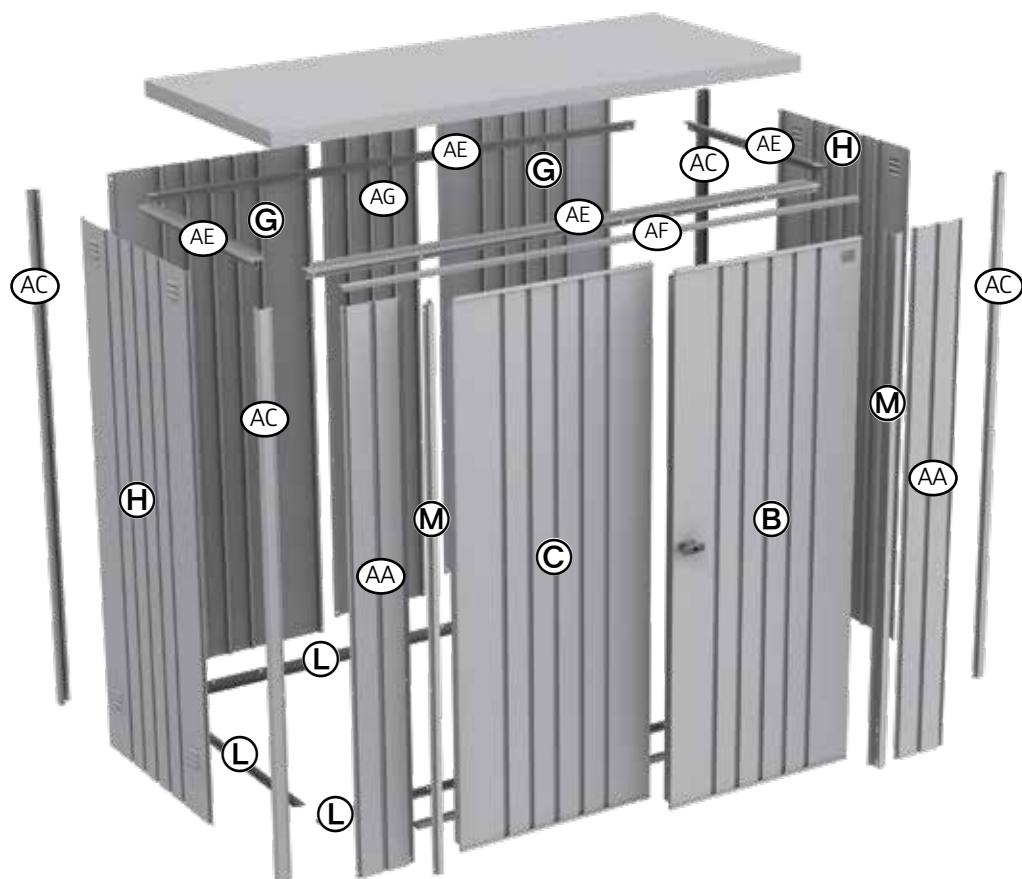
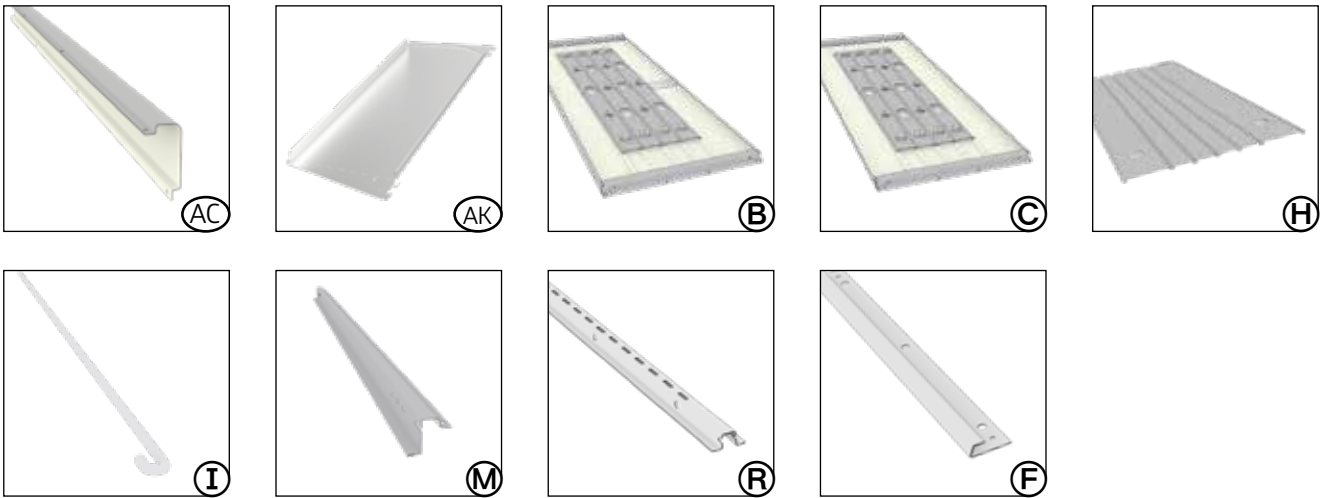

2 KORPUS - TÜRPAKET



Corpus-door package · Carton de l'ossature et la porte deur-corpus paket · Paquete de la puerta y del corpus · Pacchetto di corpus e porta · Dørpakke kasse · Stomdörrspaket · Corpus-dør pakke · opakowanie zawierające drzwi i elementy ścienne · Korpus - dverný set · Paket korpusnih vrata · Korpus - dveřní set · Korpusz-ajtócsomag · Paket korpusnih vrata · Pachet panou-usa



1.

 Ⓛ	GS 90: 2x L1 (770mm) 2x L2 (870mm) GS 150: 2x L1 (770mm) 2x L2 (1490mm) GS 190: 2x L1 (770mm) 2x L2 (1850mm) GS 230: 2x L1 (770mm) 2x L2 (2210mm)	 Ⓧ	GS 90: 1x	 Ⓨ	GS 90: 1x
M4 x 10    ⓓ2	GS 90: 10x GS 150: 4x GS 190: 4x GS 230: 4x				

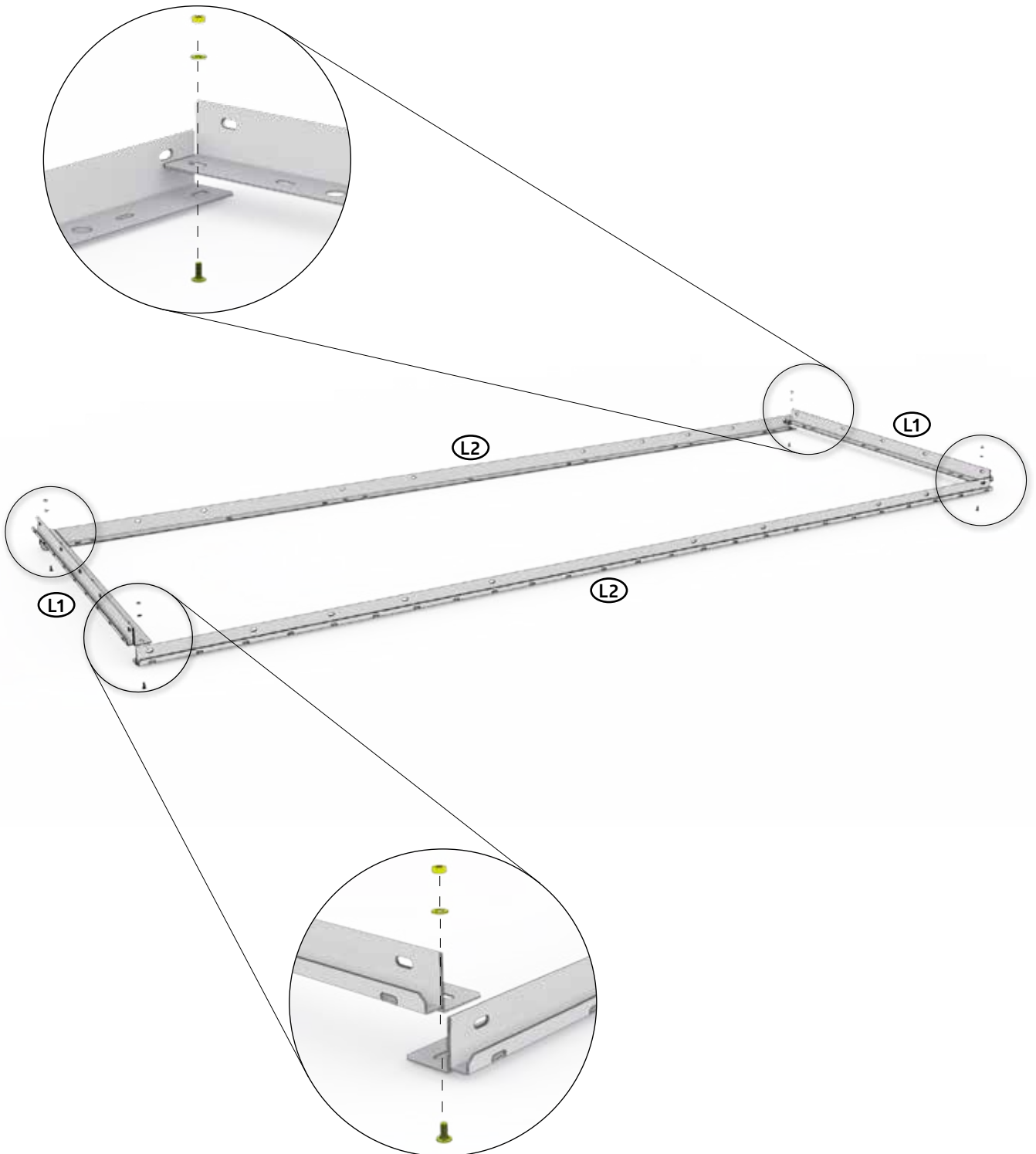





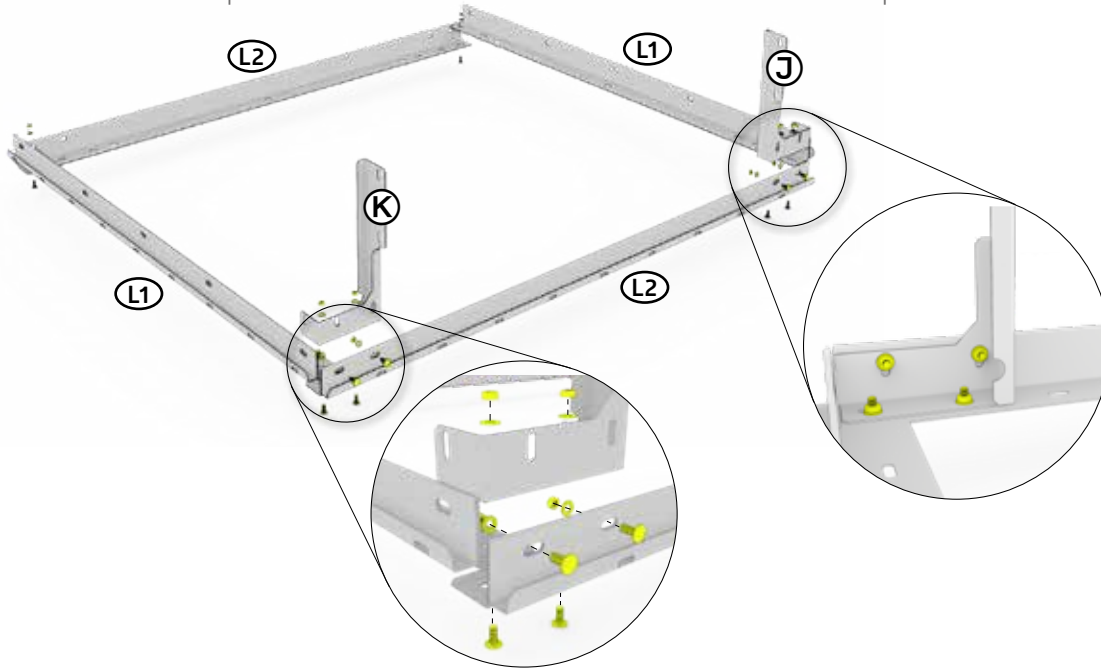

Größenabhängiger Montageschritt - Size-Dependent assembly step - Dépendant de la taille - Size-Dependent montagestep - Paso de montaje de tamaño Dependiente - Taglia-Dependent fase di montaggio - Størrelses-anhængig montage skridt - Storleksberoende monteringssteg!

Nur für Größe 90 - Only for width 90 - Juste pour la largeur de 90 - Alleen voor breedte 90 - Sólo para el ancho de 90 - Solo per larghezza 90 - Kun for størrelse 90 - Endast för storlek 90 - Bare til str 90 - Czyność tylko dla wielkości 90 - Len pre veľ. 90 - Samo za velikosti 90 - Pouze pro vel. 90 - Csak 90 méret esetén - Samo za veličine 90 - Doar pentru latimea 90



Størrelsesavhengig monteringsstrinn! - Sposób montażu zależny od wielkości. - Montážny krok závislý od veľkosti! - Korak montaže odvisen od velikosti! - Montážní krok závislý na velikosti! - Mérettől függő összeszerelési lépés! - Korak sklopa ovisno o veličini! - Pas de asamblare in functie de marime

2.

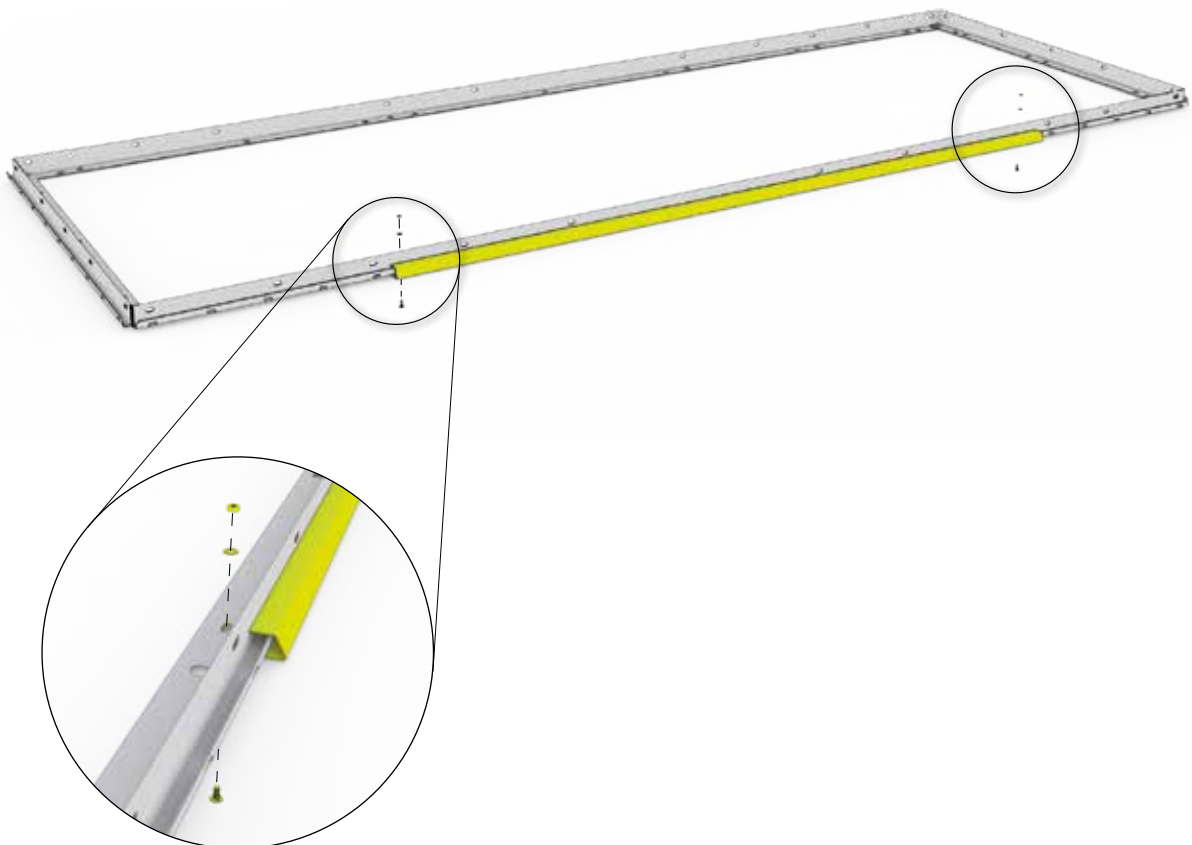

 <p>Ⓕ</p>		GS 90: 1X (690mm)	<p>M4 x 10</p>    <p>Ⓓ2</p>	GS 90: 2X
	GS 150: 1X (1380mm)	GS 150: 2X		
	GS 190: 1X (1380mm)	GS 190: 2X		
	GS 230: 1X (1380mm)	GS 230: 2X		

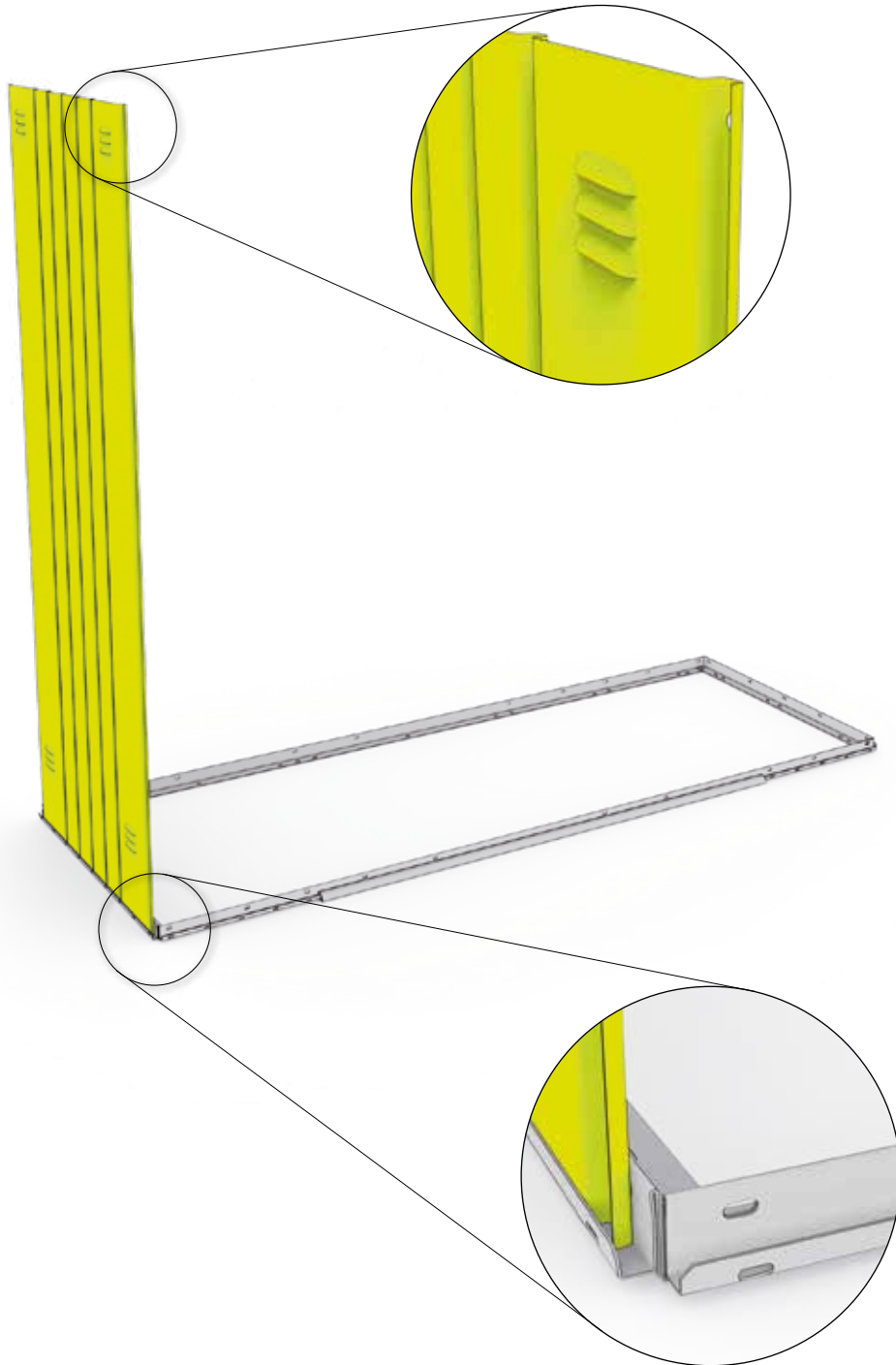
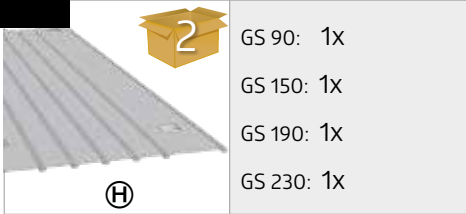

3.

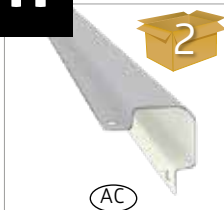

4.

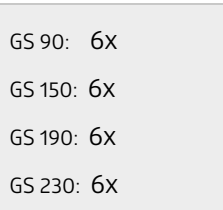
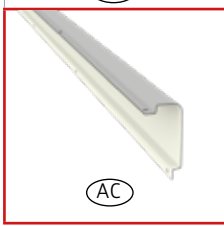
 <p>GS 150: 2x GS 190: 2x GS 230: 2x</p> <p>(AC)</p>	<p>M4 x 10</p>  <p>(D2)</p>	<p>GS 90: 6x GS 150: 6x GS 190: 6x GS 230: 6x</p>	 <p>(AB)</p>	<p>GS 90: 1x</p>
 <p>(AC)</p>	<p>GS 90: 1x</p>			

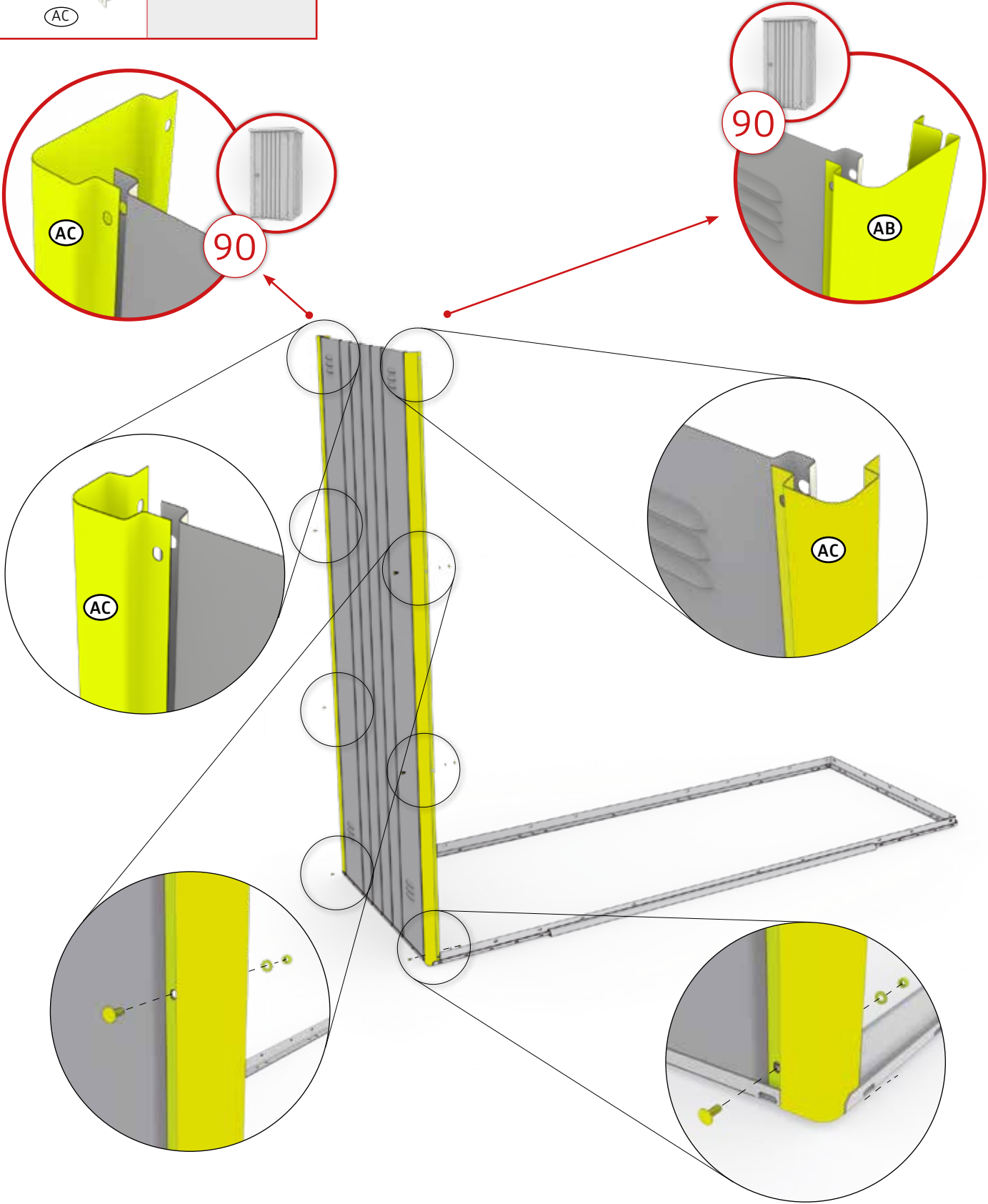



Größenabhängiger Montageschritt - Size-Dependent assembly step - Dépendant de la taille - Size-Dependent montagestep - Paso de montaje de tamaño Dependiente - Taglia-Dependent fase di montaggio - Størrelses-afhængig montage skridt - Storleksberoende monteringssteg!

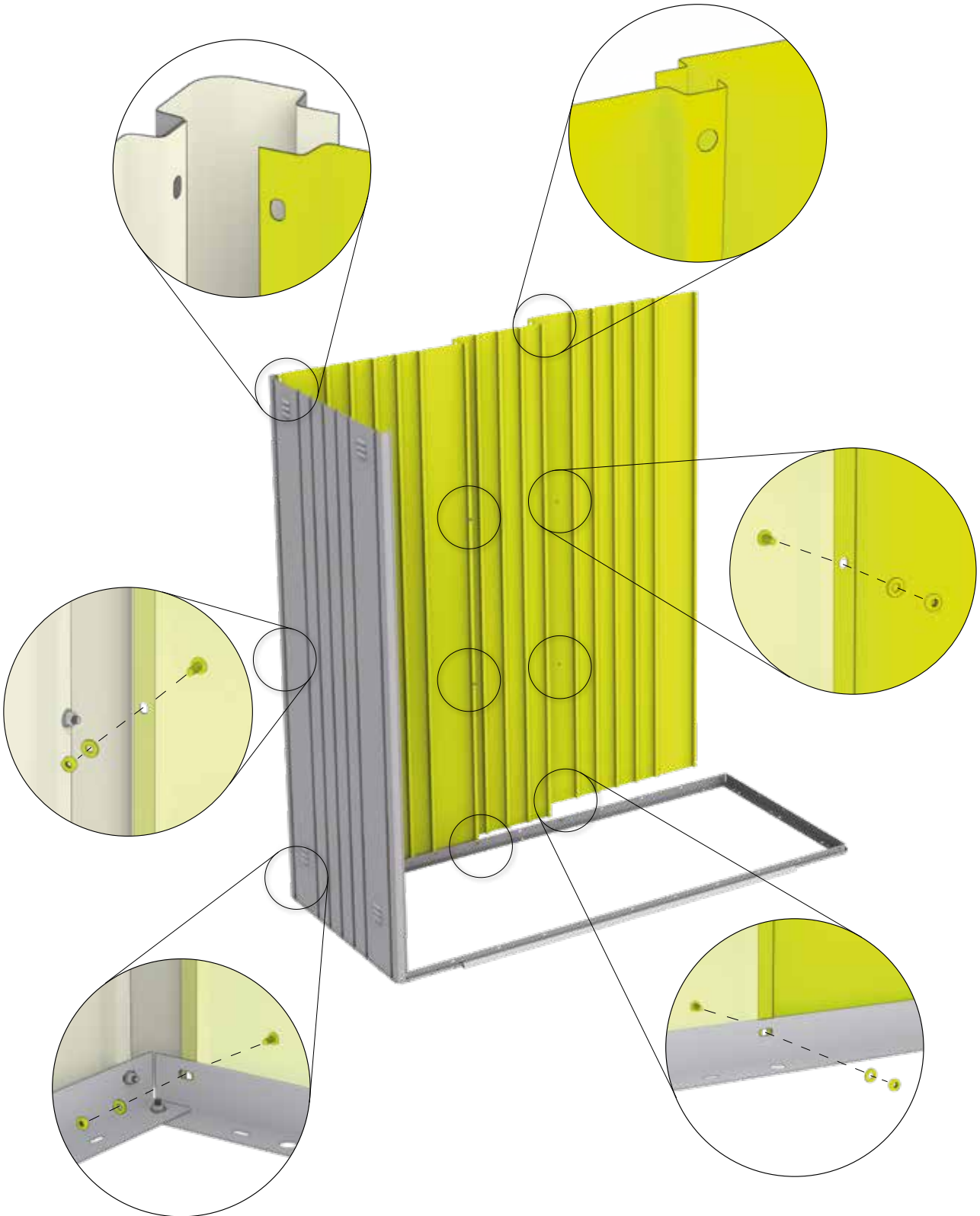

Nur für Größe 190 - Only for width 190 · Juste pour la largeur de 190 · Alleen voor breedte 190 · Sólo para el ancho de 190 · Solo per larghezza 190 · Kun for størrelse 190 · Endast för storlek 190 · Bare til str 190 · Czyność tylko dla wielkości 190 · Len pre veľ. 190 · Samo za velikosti 190 · Pouze pro vel. 190 · Csak 190 méret esetén - Samo za veličine 190 · Doar pentru latimea 190

 GS 190: 2x	 GS 190: 1x	M4 x 10 	GS 190: 9x
Ⓒ	AG	D2	

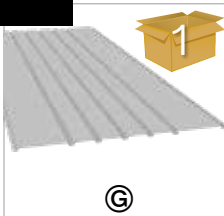

Størrelsesavhengig monteringsstrinn! - Sposób montażu zależny od wielkości. - Montážny krok závislý od veľkosti! - Korak montaže odvisen od velikosti!
- Montážní krok závislý na velikosti! - Mérettől függő összeszerelési lépés! - Korak sklopa ovisno o veličini! - Pas de asamblare în funcție de mărime

5.

	<p>GS 90: 1x GS 150: 2x GS 230: 3x</p>	<p>M4 x 10</p>  <p>D2</p>	<p>GS 90: 3x GS 150: 6x GS 230: 9x</p>
--	--	--	--

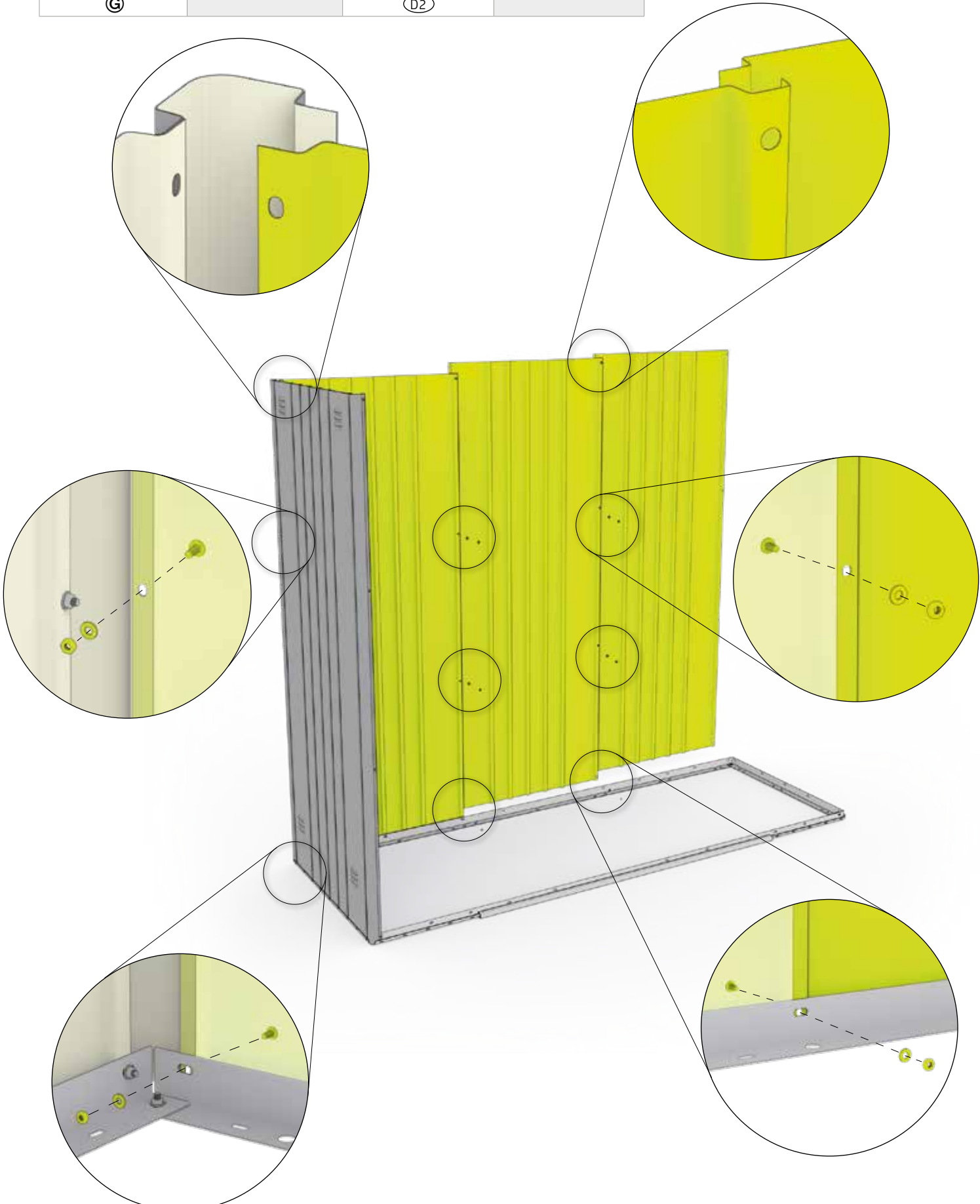

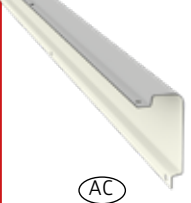

6.

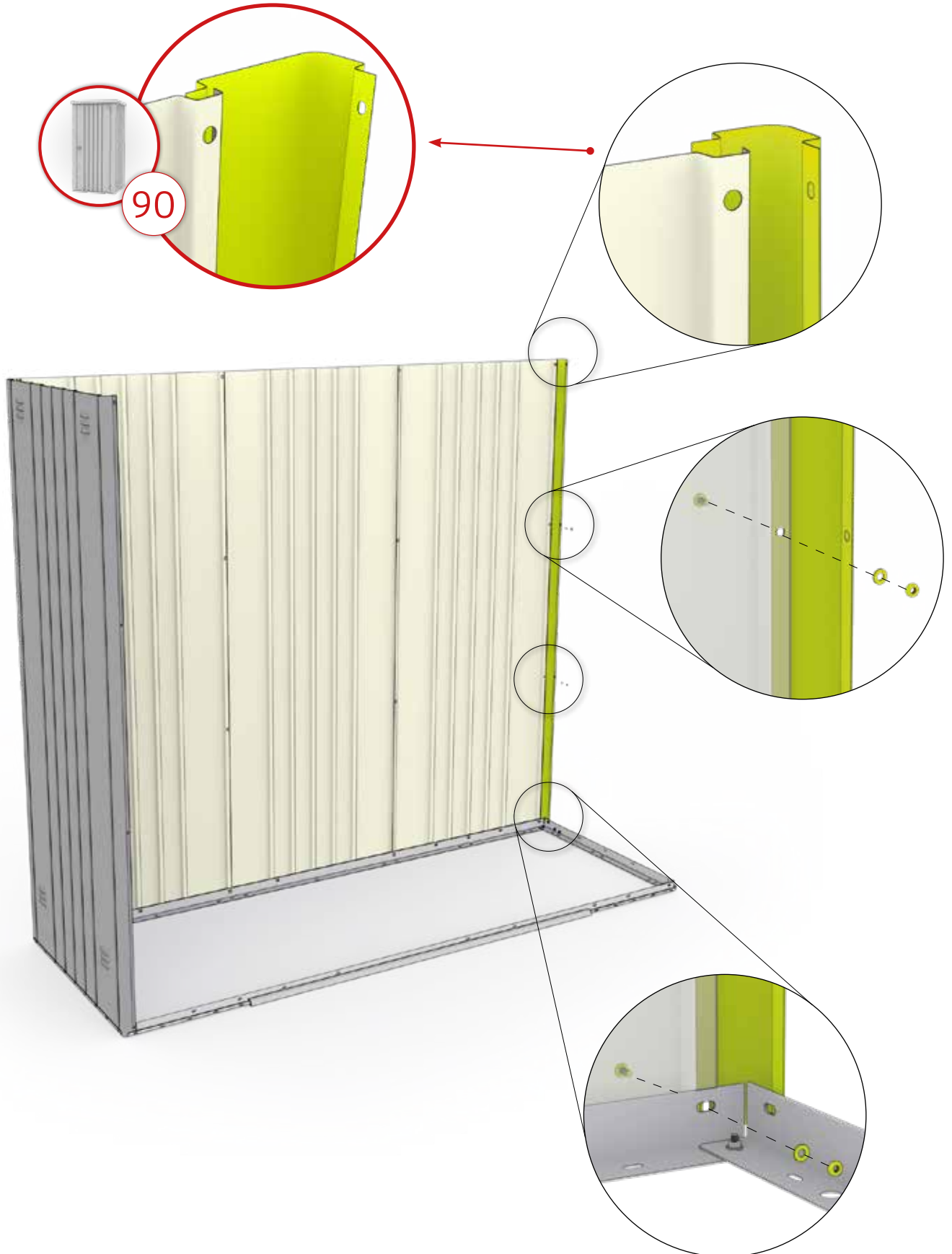
 GS 150: 1X GS 190: 1X GS 230: 1X (AC)	M4 x 10 (D2)	GS 90: 3X GS 150: 3X GS 190: 3X GS 230: 3X	 GS 90: 1X (AC)
---	-----------------	---	--



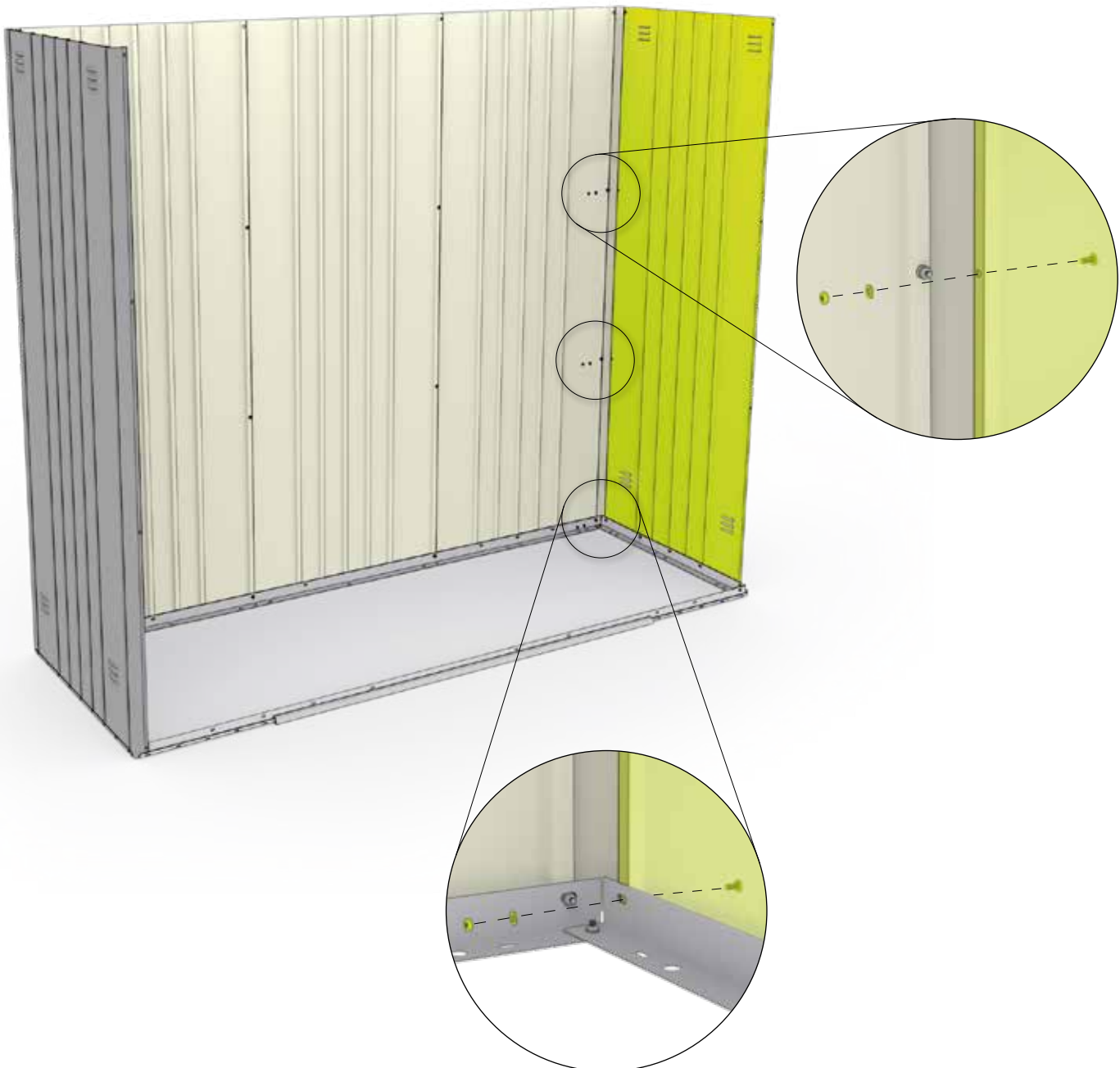

7.

		GS 90: 1x		M4 x 10	GS 90: 3x
		GS 150: 1x		GS 150: 3x	
		GS 190: 1x		GS 190: 3x	
		GS 230: 1x		GS 230: 3x	





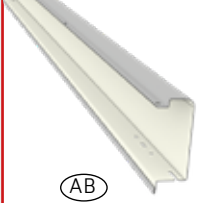

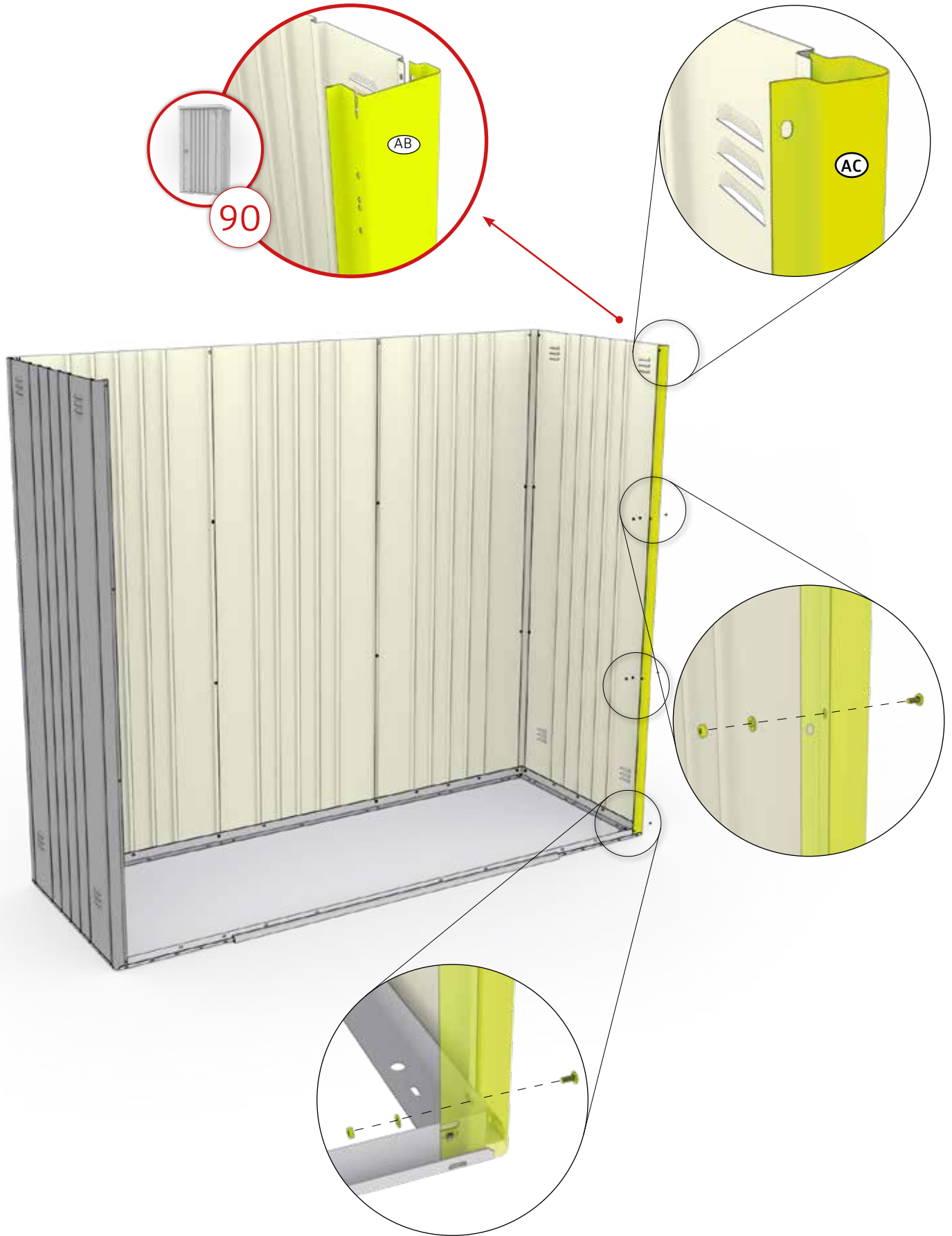
8.

 AC	 GS 150: 1x GS 190: 1x GS 230: 1x	M4 x 10  D2	GS 90: 3x GS 150: 3x GS 190: 3x GS 230: 3x	 AB	GS 90: 1x
---	---	--	---	---	-----------



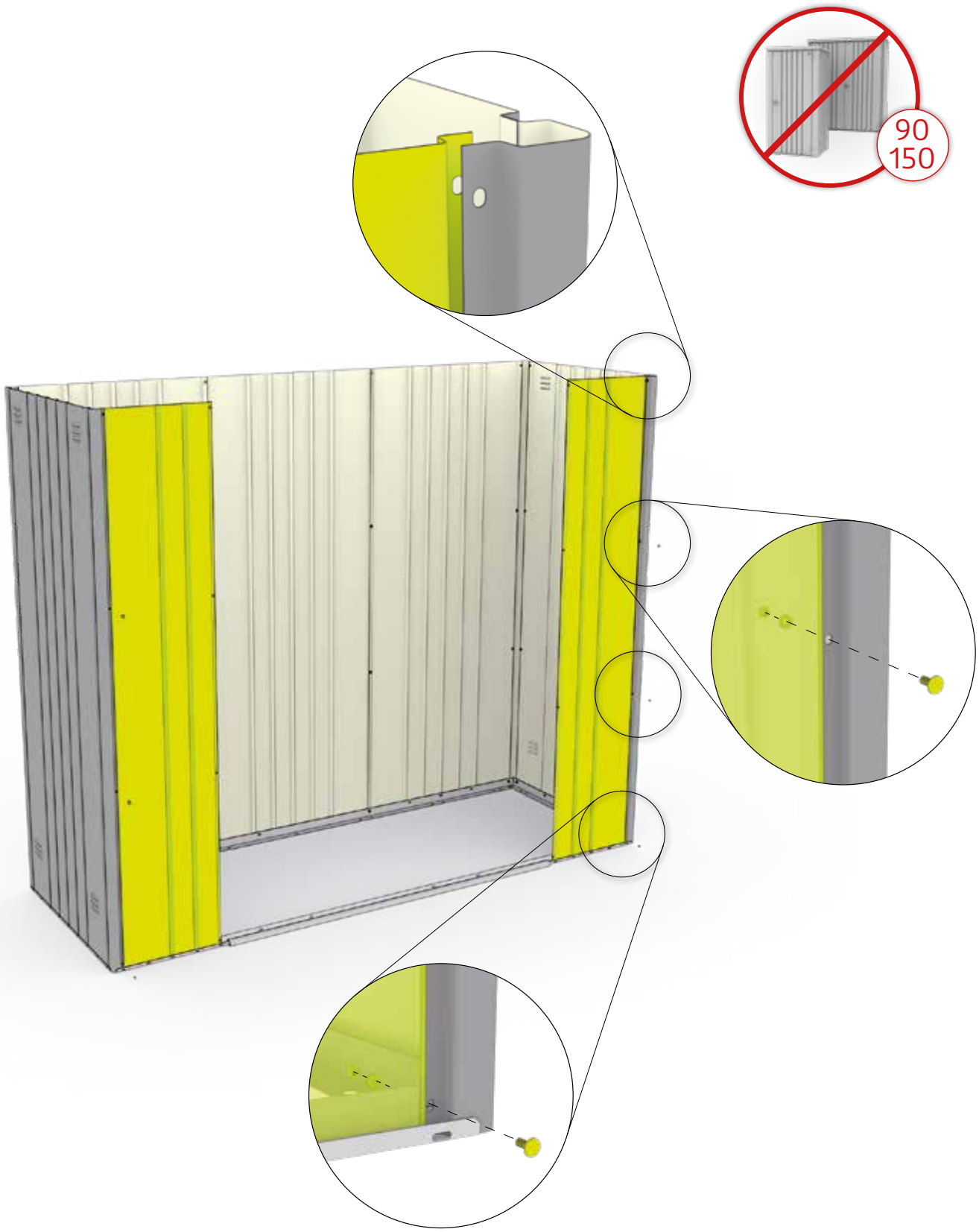

9.

 Ⓐ	 GS 230: 2x	 ⒶⒶ	 GS 190 2x	M4 x 10  ⒹⒺ	GS 190: 6x GS 230: 6x
--	---	---	--	--	--------------------------





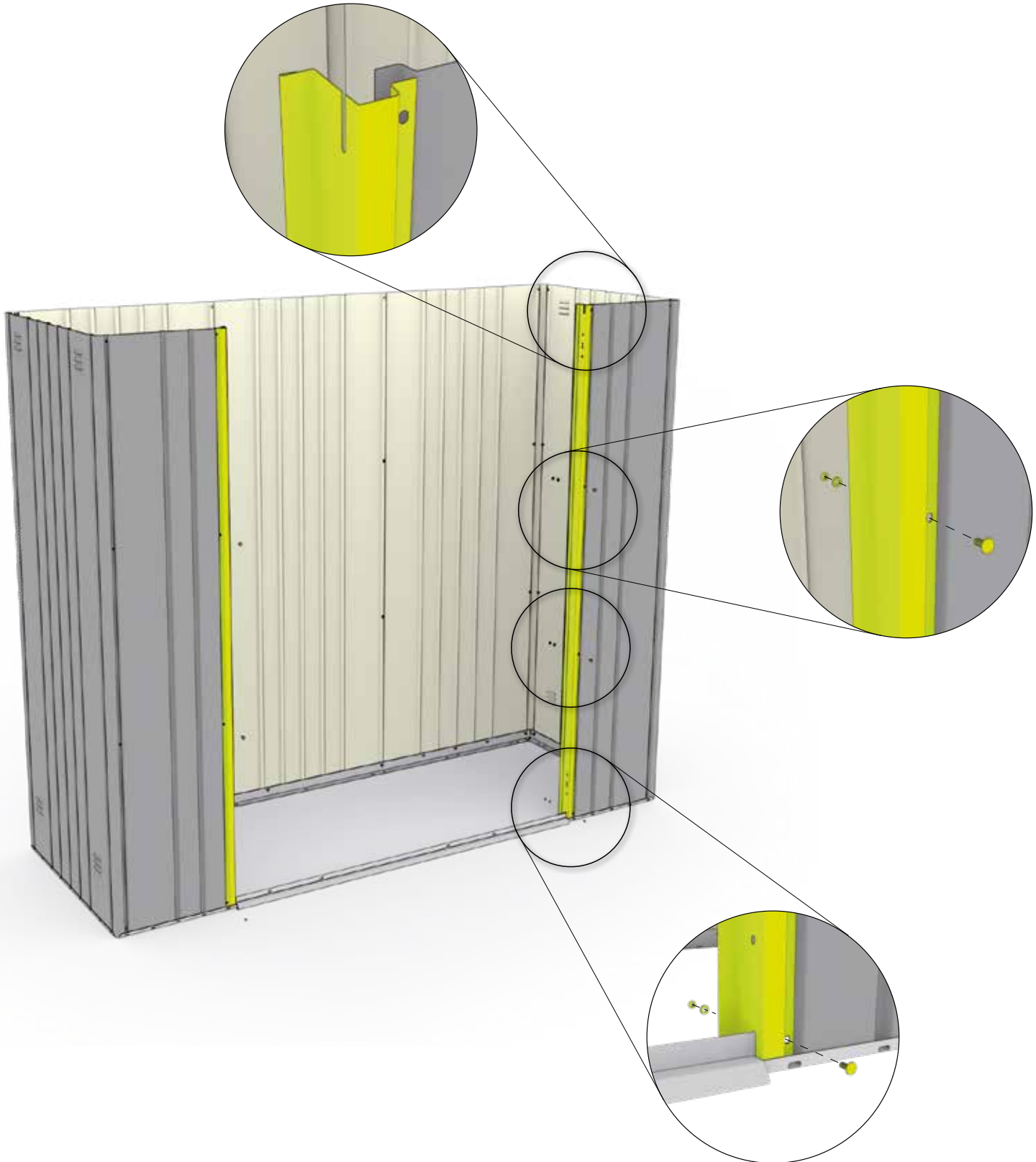

10.

		GS 150: 2X		M4 x 10	GS 150: 6X
		GS 190: 2X		GS 190: 6X	
		GS 230: 2X		GS 230: 6X	

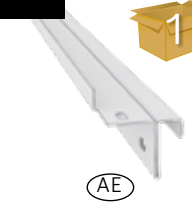

11.



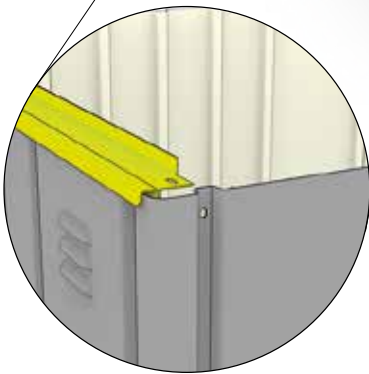
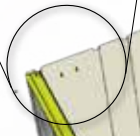
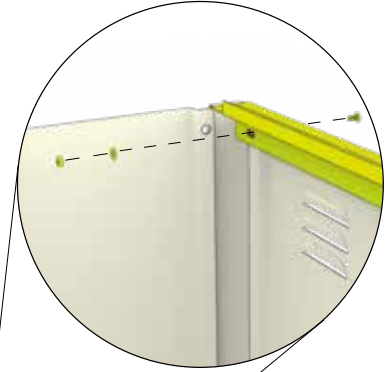
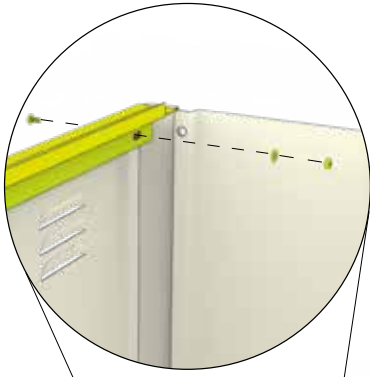





 (AE)		GS 90: 2X (770mm)	   (D2)	GS 90: 2X
		GS 150: 2X (770mm)		GS 150: 2X
		GS 190: 2X (770mm)		GS 190: 2X
		GS 230: 2X (770mm)		GS 230: 2X
		M4 x 10		



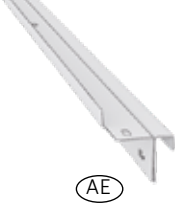

Größenabhängiger Montageschritt - Size-Dependent assembly step - Dépendant de la taille - Size-Dependent montagestep - Paso de montaje de tamaño Dependiente - Taglia-Dependent fase di montaggio - Størrelses-afhængig montage skridt - Storleksberoende monteringssteg! -





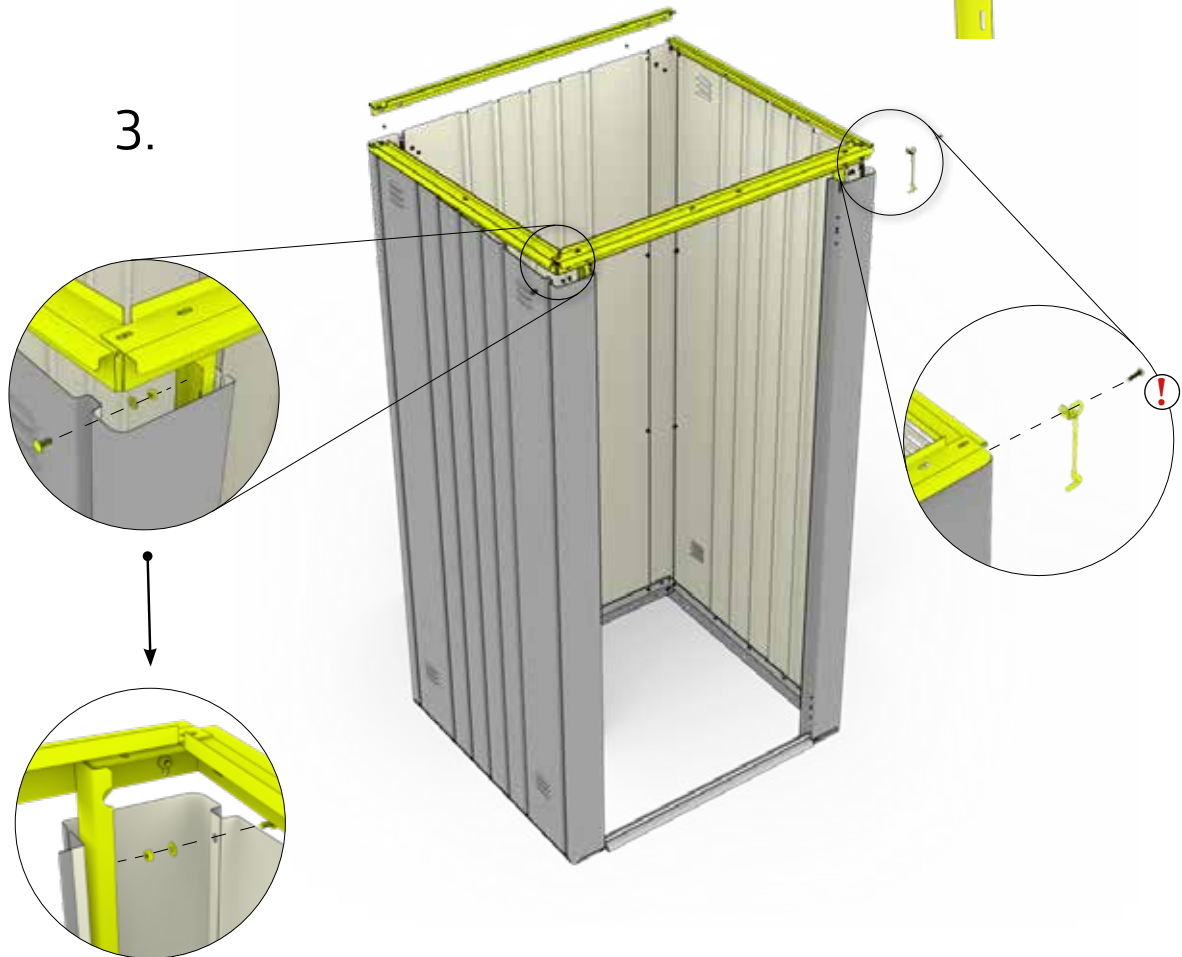
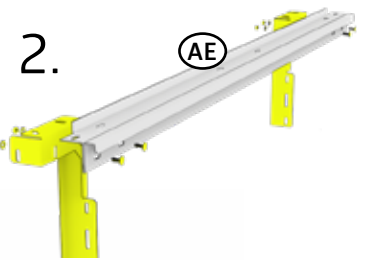



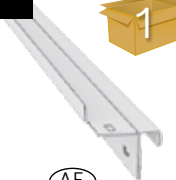

Nur für Größe 90 - Only for width 90 · Juste pour la largeur de 90 · Alleen voor breedte 90 · Sólo para el ancho de 90 · Solo per larghezza 90 · Kun for størrelse 90 · Endast för storlek 90 · Bare til str 90 · Czyność tylko dla wielkości 90 · Len pre veľ. 90 · Samo za velikosti 90 · Pouze pro vel. 90 · Csak 90 méret esetén - Samo za veličine 90 · Doar pentru latimea 90

 ⓐ	GS 90: 1x	 Ⓚ	GS 90: 1x	 ⓐⓔ	GS 90: 2x (870mm)
 ⓓ1	GS 90: 1x	 ⓓ1	GS 90: 1x	 ⓓ1	GS 90: 1x
M4 x 18  ⓓ2	GS 90: 1x	M4 x 10  ⓓ2	GS 90: 9x		



Størrelsesavhengig monteringsstrinn! - Sposób montażu zależny od wielkości. - Montážny krok závislý od veľkosti! - Korak montaže odvisen od velikosti!
- Montážní krok závislý na velikosti! - Mérettől függő összeszerelési lépés! - Korak sklopa ovisno o veličini! - Pas de asamblare in functie de marime

12.

 <p>(AE)</p>	 <p>GS 150: 2X (1490mm) GS 190: 2X (1850mm) GS 230: 2X (2210mm)</p>	 <p>(D1)</p>	 <p>GS 150: 2X GS 190: 2X GS 230: 2X</p>	 <p>(D1)</p>	<p>GS 150: 2X GS 190: 2X GS 230: 2X</p>
 <p>(D1)</p>	<p>GS 150: 2X GS 190: 2X GS 230: 2X</p>	 <p>(D1)</p>	<p>GS 150: 2X GS 190: 2X GS 230: 2X</p>	<p>M4 x 10</p>  <p>(D2)</p>	<p>GS 150: 5X GS 190: 8X GS 230: 8X</p>
<p>M4 x 18</p>  <p>(D2)</p>	<p>GS 150: 2X GS 190: 2X GS 230: 2X</p>	 <p>90</p>			

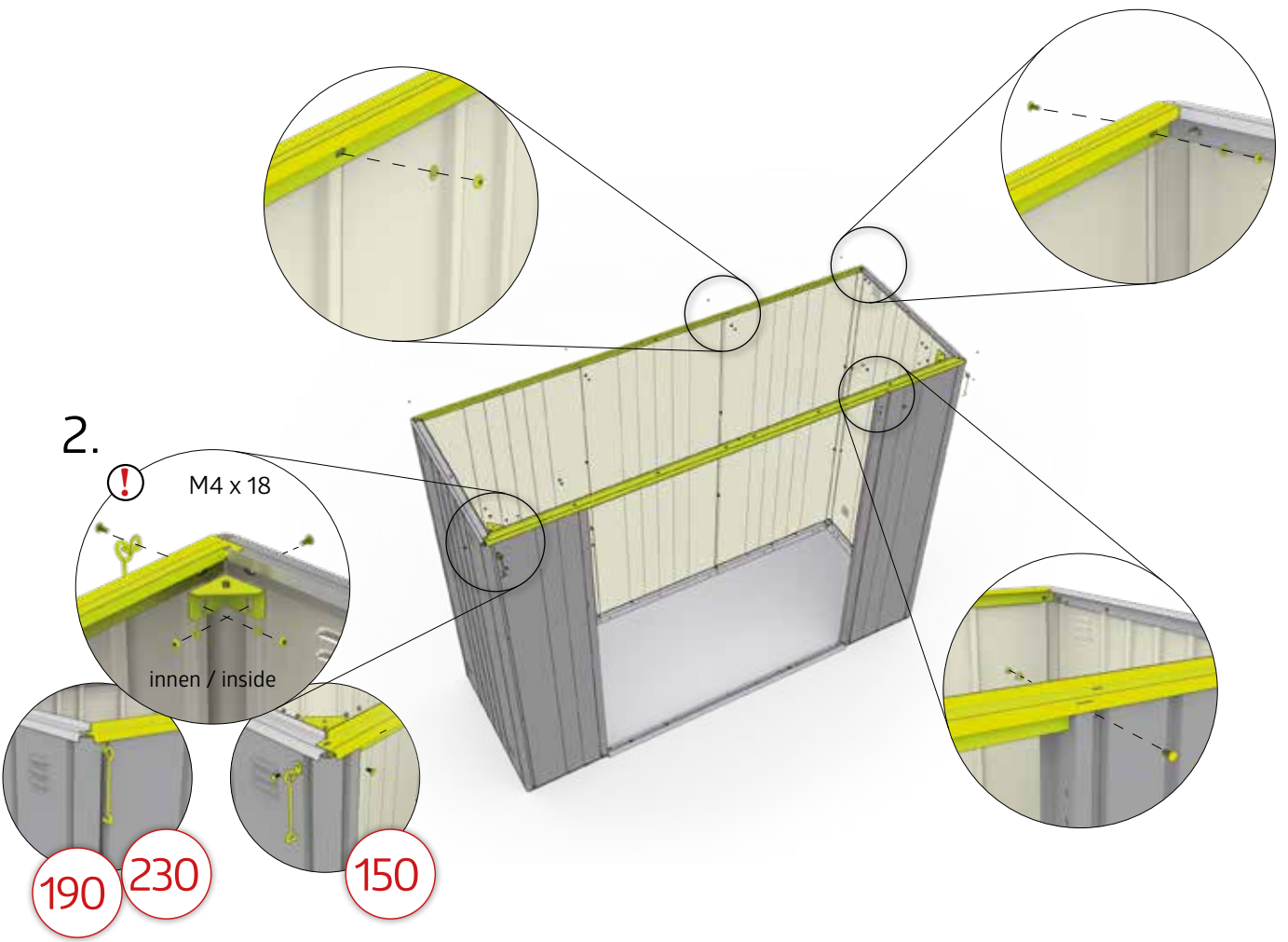
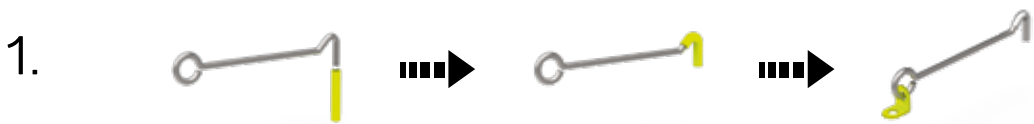



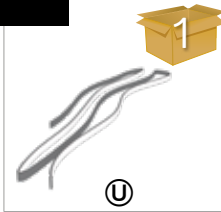

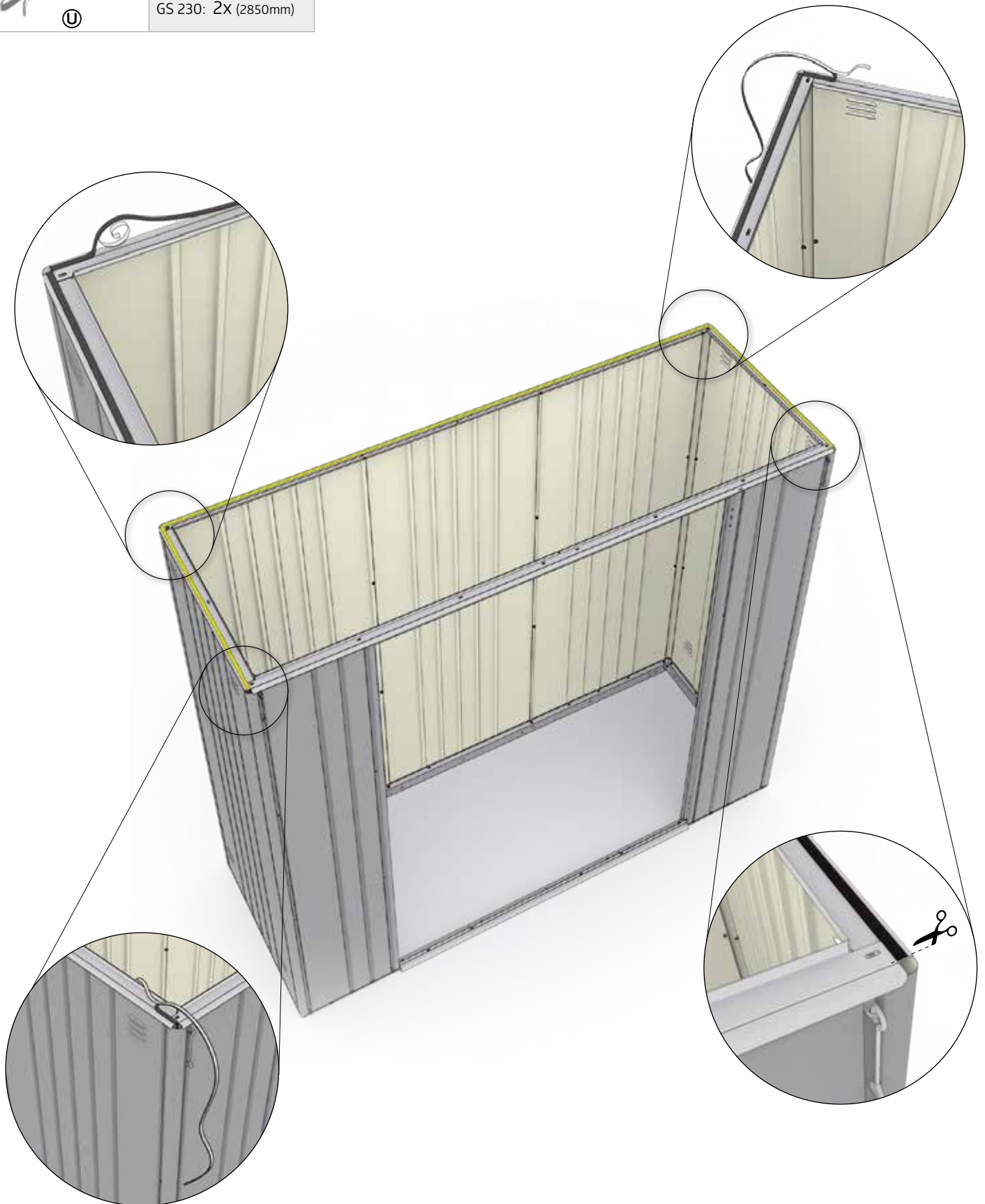
13.

	GS 90: 1X (2850mm) GS 150: 2X (2850mm) GS 190: 2X (2850mm) GS 230: 2X (2850mm)
--	---



14.

 Ⓢ	 GS 90: 1X GS 150: 2X GS 190: 3X GS 230: 3X	 Ⓨ	 GS 90: 1X GS 150: 2X GS 190: 3X GS 230: 3X
---	--	--	--

1.

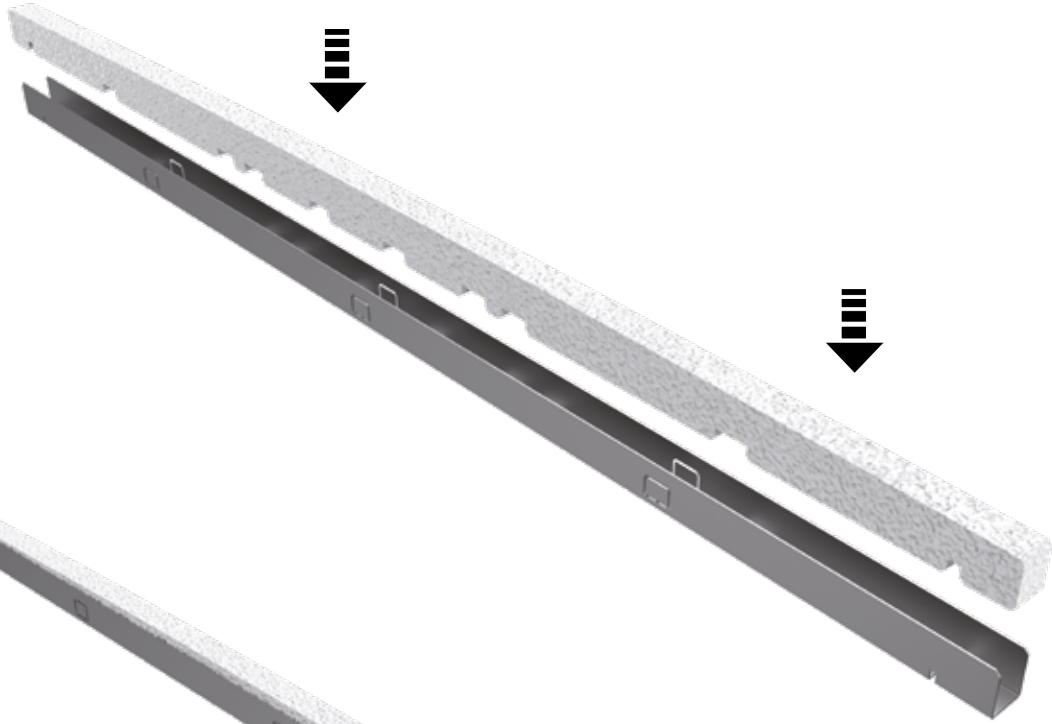

2.

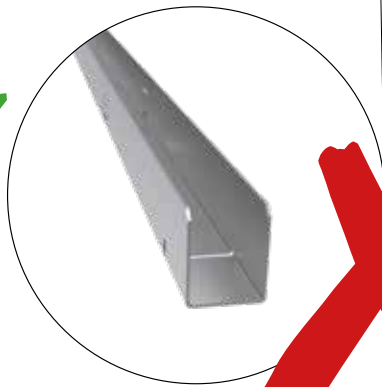
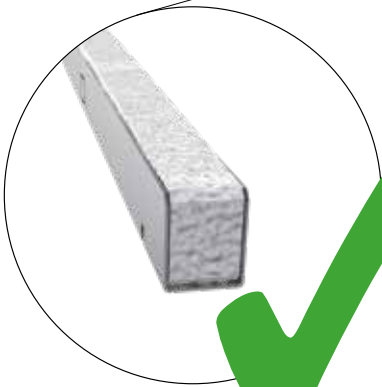

15.

	GS 90: 1X
	GS 150: 1X
	GS 190: 1X
	GS 230: 1X

⊗

1.

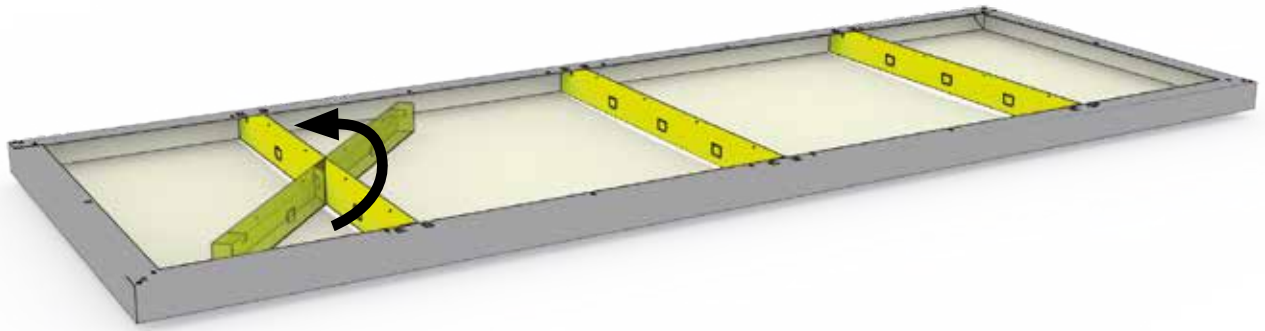



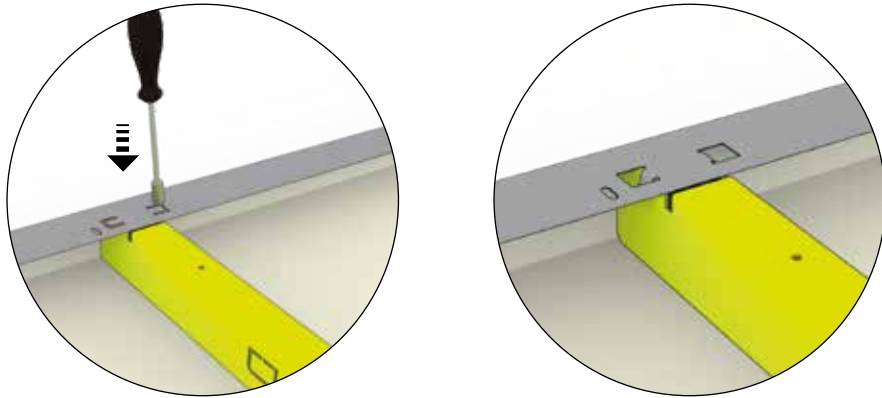

2.



3.



16.

M4 x 10 D2		GS 90: 14x
		GS 150: 8x
		GS 190: 14x
		GS 230: 18x

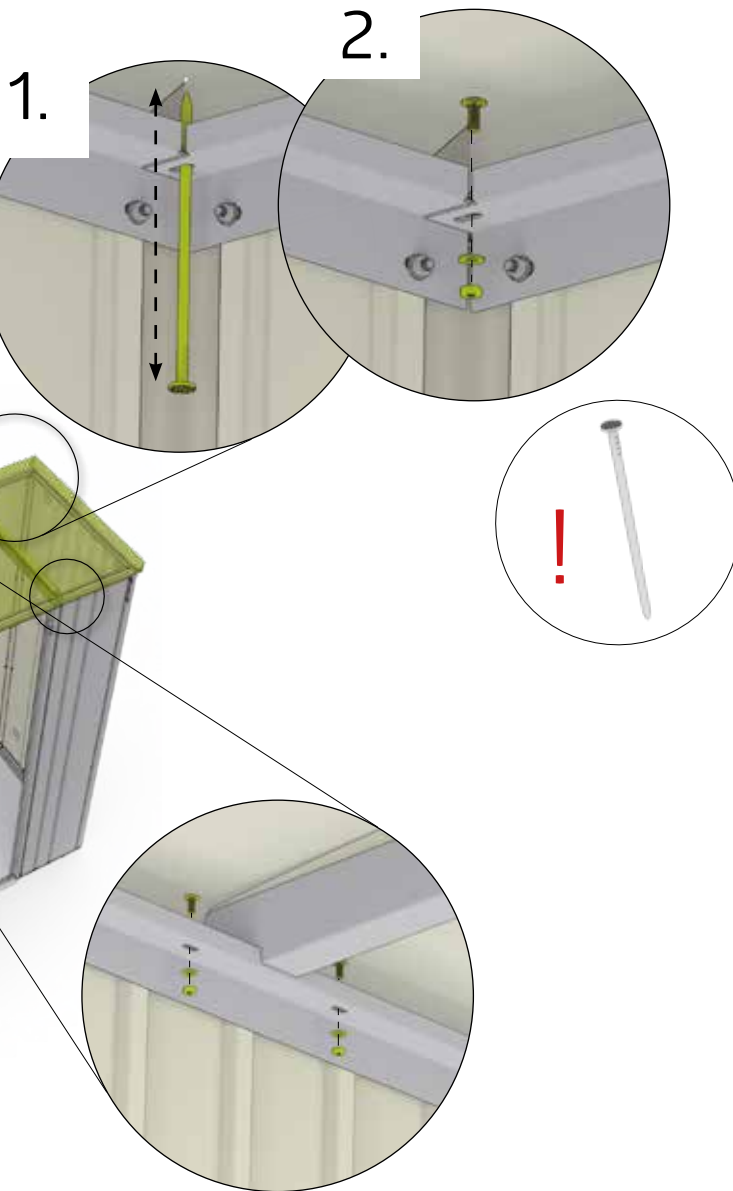

Größenabhängiger Montageschritt - Size-Dependent assembly step - Dépendant de la taille - Size-Dependent montagestep - Paso de montaje de tamaño Dependiente - Taglia-Dependent fase di montaggio - Størrelses-afhængig montage skridt - Storleksberoende monteringssteg!

Nur für Größe 90 - Only for width 90 - Juste pour la largeur de 90 - Alleen voor breedte 90 - Sólo para el ancho de 90 - Solo per larghezza 90 - Kun for størrelse 90 - Endast för storlek 90 - Bare til str 90 - Czyność tylko dla wielkości 90 - Len pre veľ. 90 - Samo za velikosti 90 - Pouze pro vel. 90 - Csak 90 méret esetén - Samo za veličine 90 - Doar pentru latimea 90

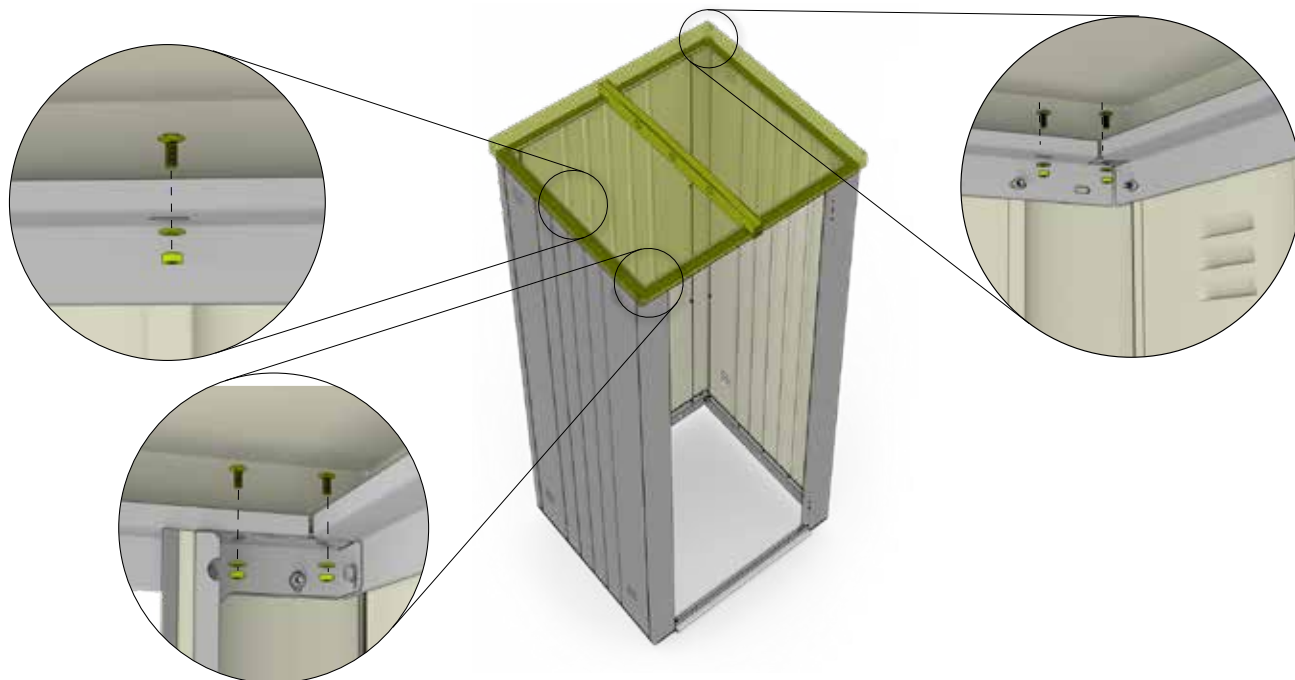

Størrelsesafhængig monteringsstrinn! - Sposób montażu zależny od wielkości. - Montážny krok závislý od veľkosti! - Korak montaže odvisen od velikosti! - Montážní krok závislý na velikosti! - Mérettől függő összeszerelési lépés! - Korak sklopa ovisno o veličini! - Pas de asamblare în funcție de marime



Größenabhängiger Montageschritt - Size-Dependent assembly step - Dépendant de la taille - Size-Dependent montagestep - Paso de montaje de tamaño Dependiente - Taglia-Dependent fase di montaggio - Størrelses-afhængig montage skridt - Storleksberoende monteringssteg!

Nur für Größe 90 - Only for width 90 · Juste pour la largeur de 90 · Alleen voor breedte 90 · Sólo para el ancho de 90 · Solo per larghezza 90 · Kun for størrelse 90 · Endast för storlek 90 · Bare til str 90 · Czyność tylko dla wielkości 90 · Len pre veľ. 90 · Samo za velikosti 90 · Pouze pro vel. 90 · Csak 90 méret esetén - Samo za veličine 90 · Doar pentru latimea 90

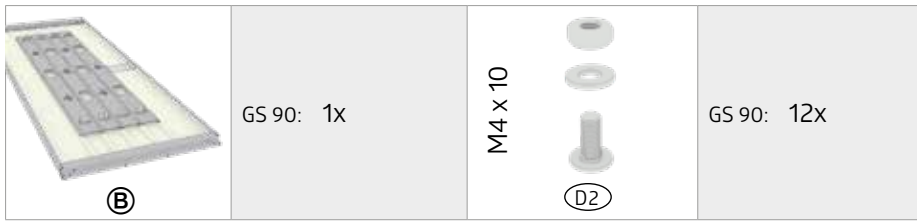

Variante 1 Proposal 1, Variant 1

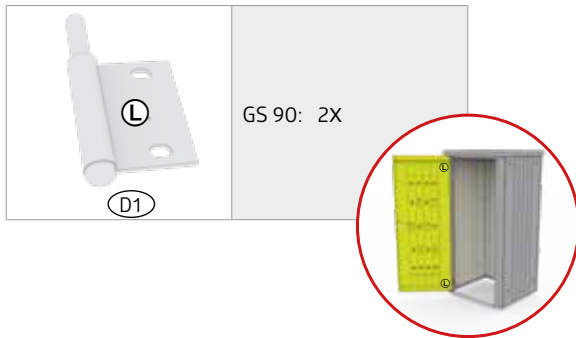



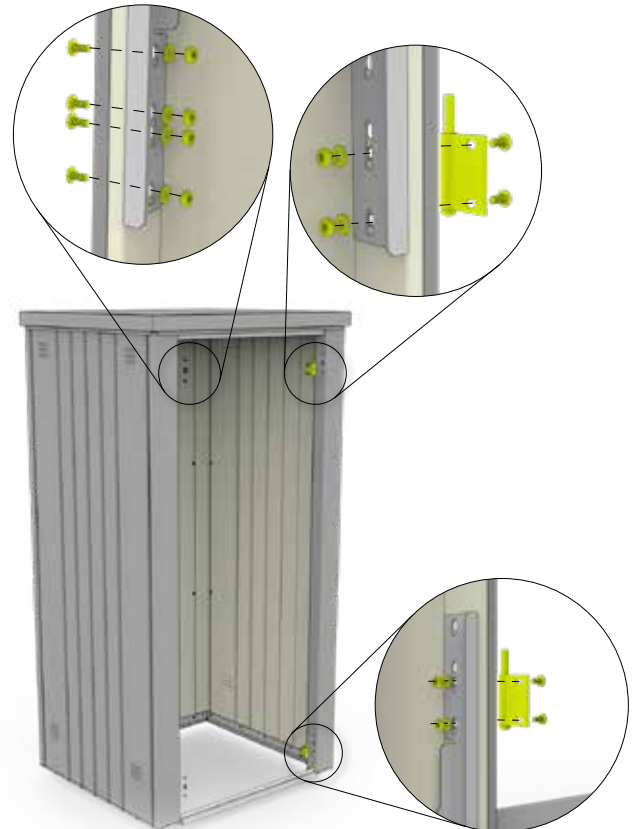
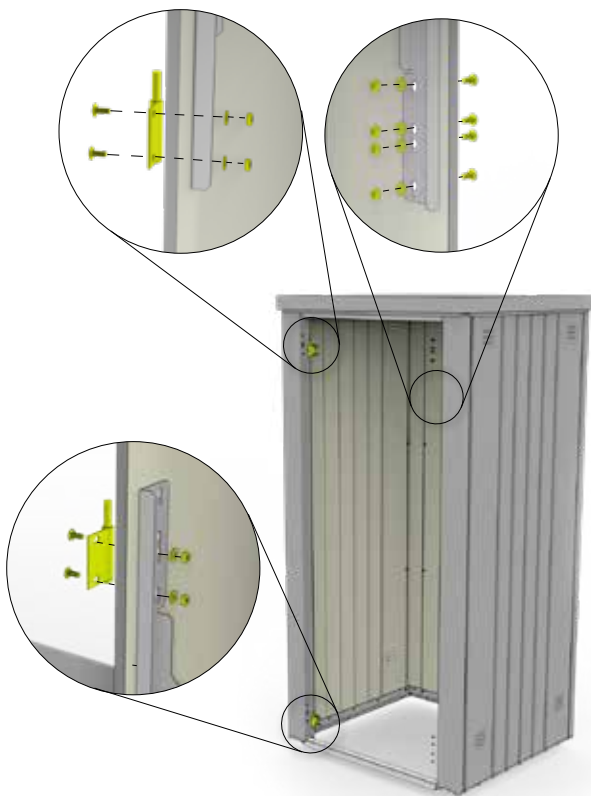

Variante 2 Proposal 2, Variant 2



Størrelsesafhængig monteringsstrinn! - Sposób montażu zależny od wielkości. - Montážny krok závislý od veľkosti! - Korak montaže odvisen od velikosti!
- Montážní krok závislý na velikosti! - Mérettől függő összeszerelési lépés! - Korak sklopa ovisno o veličini! - Pas de asamblare in functie de marime

17.

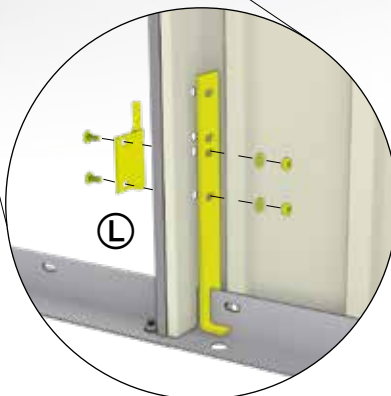
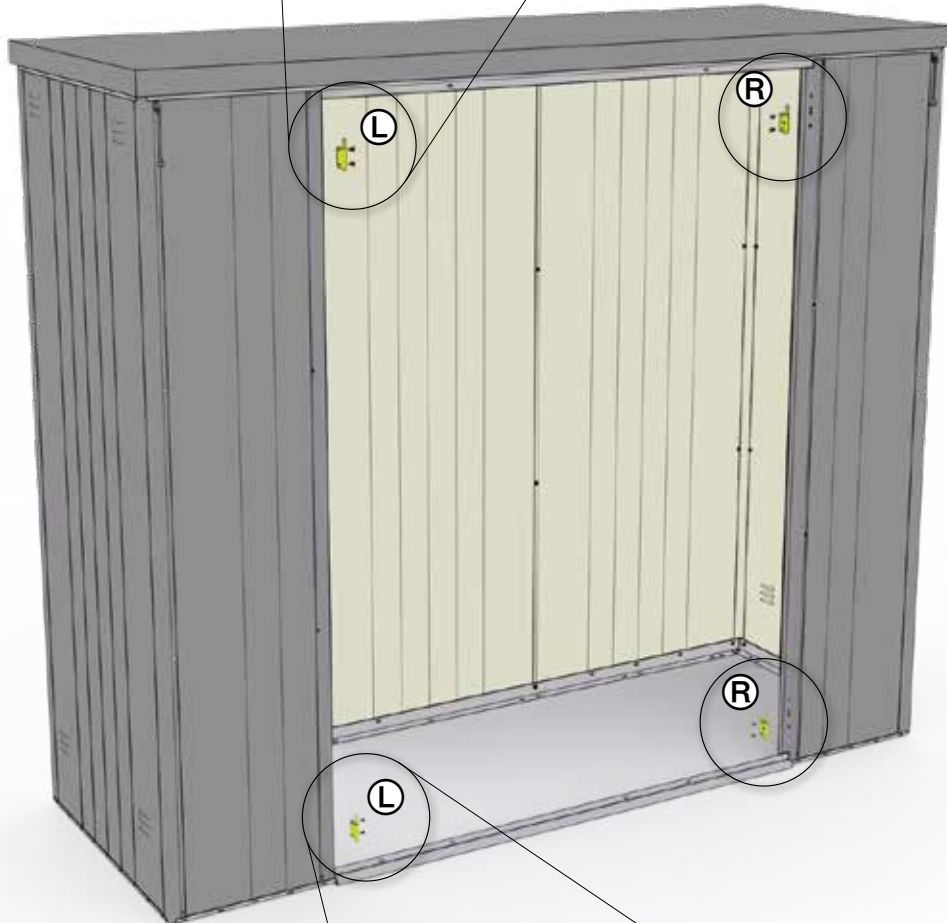
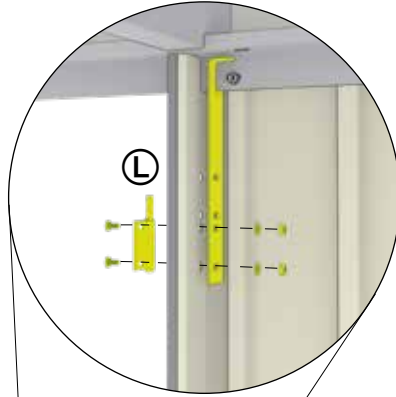

 <p>(D1)</p>	<p>GS 150: 4X GS 190: 4X GS 230: 4X</p>	 <p>(D1)</p>	<p>GS 150: 2X GS 190: 2X GS 230: 2X</p>	 <p>(D1)</p>	<p>GS 150: 2X GS 190: 2X GS 230: 2X</p>
<p>M4 x 10</p>  <p>(D2)</p>	<p>GS 150: 8X GS 190: 8X GS 230: 8X</p>				





Größenabhängiger Montageschritt - Size-Dependent assembly step - Dépendant de la taille - Size-Dependent montagestep - Paso de montaje de tamaño Dependiente - Taglia-Dependent fase di montaggio - Størrelses-anhængig montage skridt - Storleksberoende monteringssteg!

Nur für Größe 90 - Only for width 90 · Juste pour la largeur de 90 · Alleen voor breedte 90 · Sólo para el ancho de 90 · Solo per larghezza 90 · Kun for størrelse 90 · Endast för storlek 90 · Bare til str 90 · Czyność tylko dla wielkości 90 · Len pre veľ. 90 · Samo za velikosti 90 · Pouze pro vel. 90 · Csak 90 méret esetén - Samo za veličine 90 · Doar pentru latimea 90

	GS 90: 2x	M4 x 10 	GS 90: 4x
(D1)			

Variante 1 Proposal 1, Variant 1

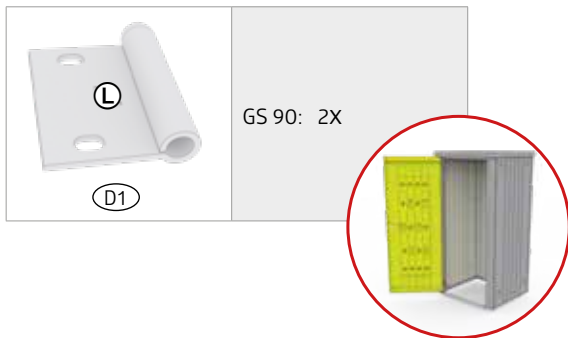

Variante 2 Proposal 2, Variant 2

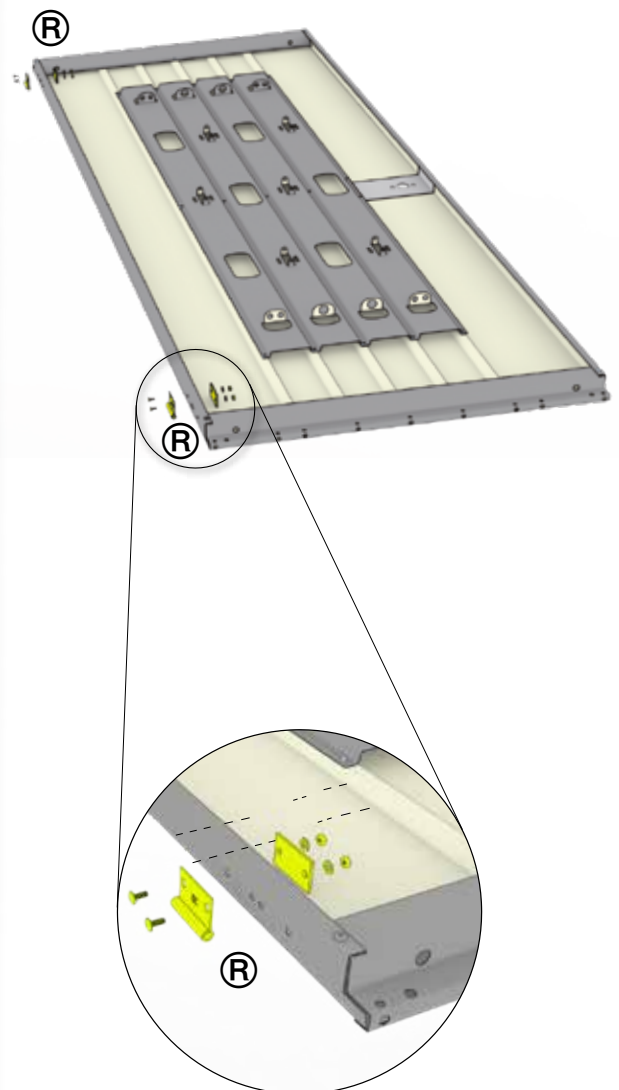
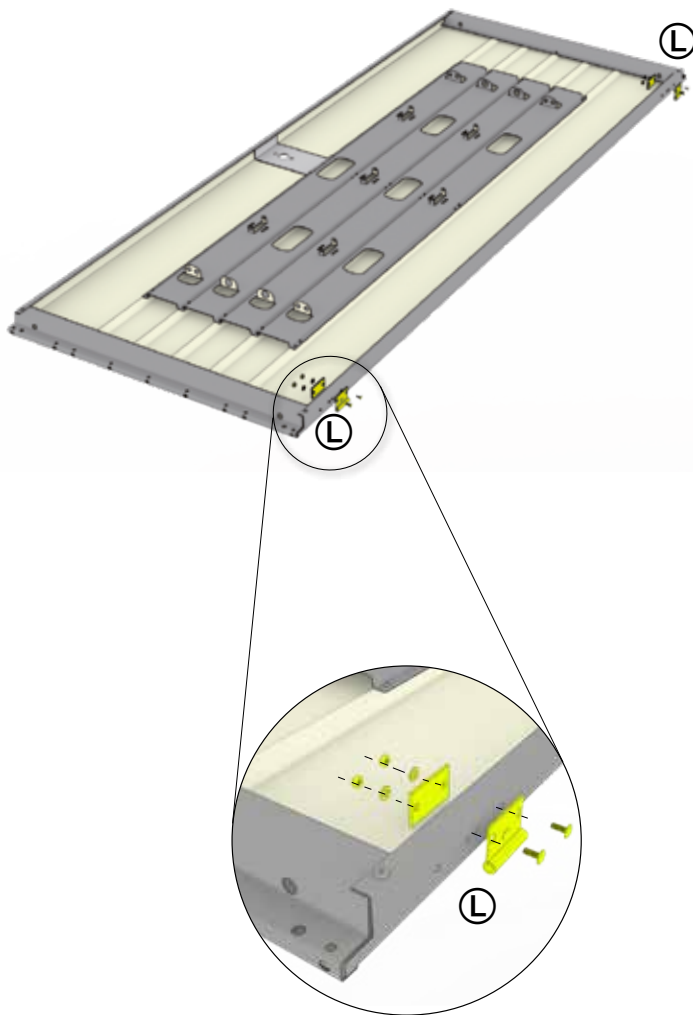



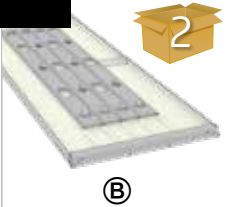
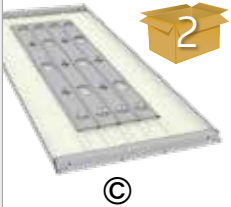
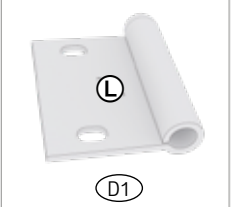
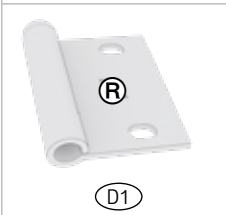
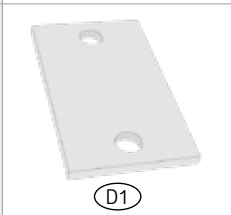
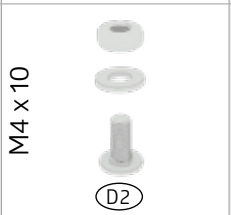

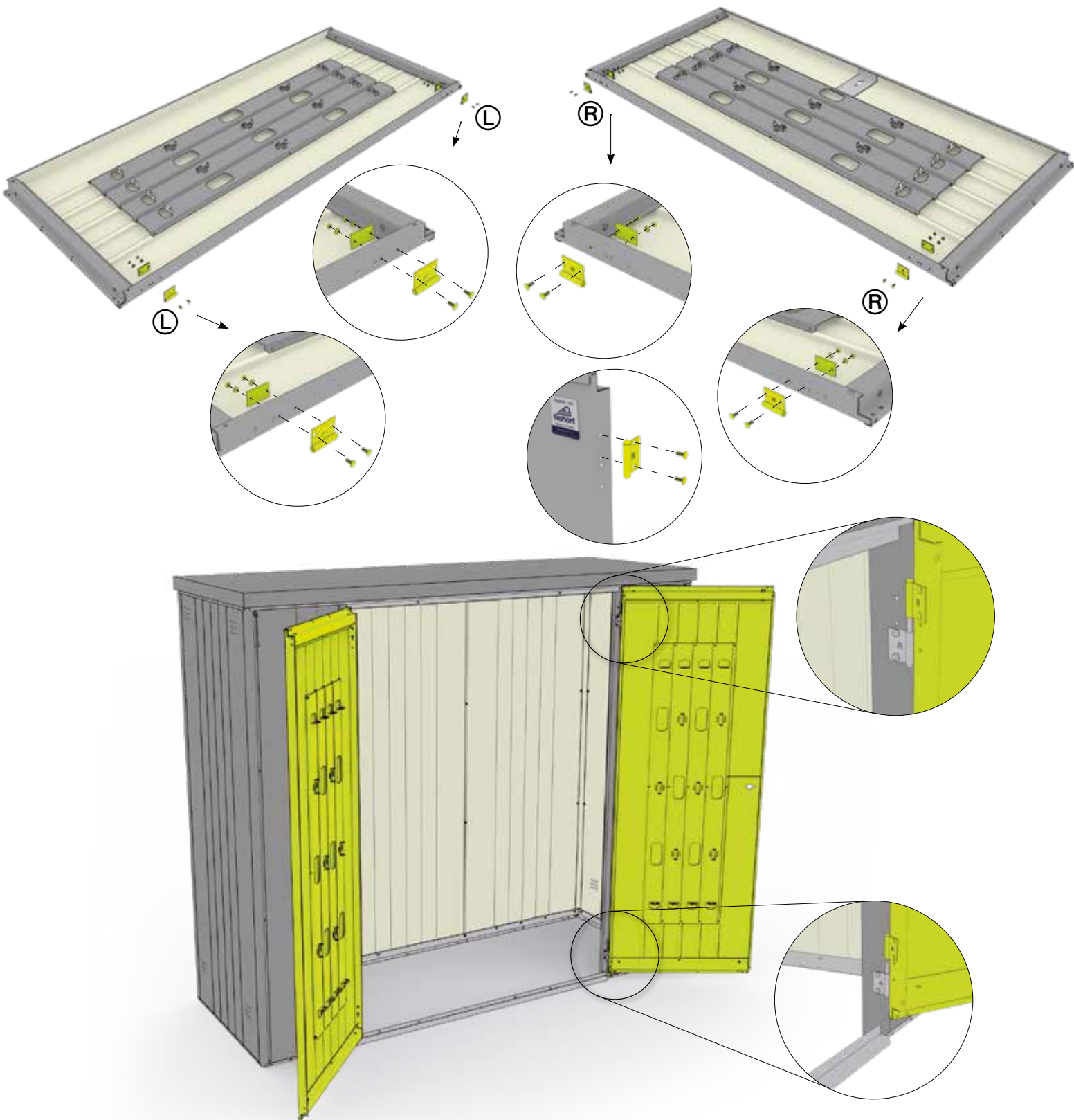
Størrelsesavhengig monteringsstrinn! - Sposób montażu zależny od wielkości. - Montážny krok závislý od veľkosti! - Korak montaže odvisen od velikosti!
- Montážní krok závislý na velikosti! - Méretől függő összeszerelési lépés! - Korak sklopa ovisno o veličini! - Pas de asamblare in functie de marime



 <p>ⓑ</p>	<p>GS 150: 1X GS 190: 1X GS 230: 1X</p>	 <p>ⓒ</p>	<p>GS 150: 1X GS 190: 1X GS 230: 1X</p>	 <p>ⓓ1</p>	<p>GS 150: 2X GS 190: 2X GS 230: 2X</p>
 <p>ⓓ1</p>	<p>GS 150: 2X GS 190: 2X GS 230: 2X</p>	 <p>ⓓ1</p>	<p>GS 150: 4X GS 190: 4X GS 230: 4X</p>	<p>M4 x 10</p>  <p>ⓓ2</p>	<p>GS 150: 8X GS 190: 8X GS 230: 8X</p>

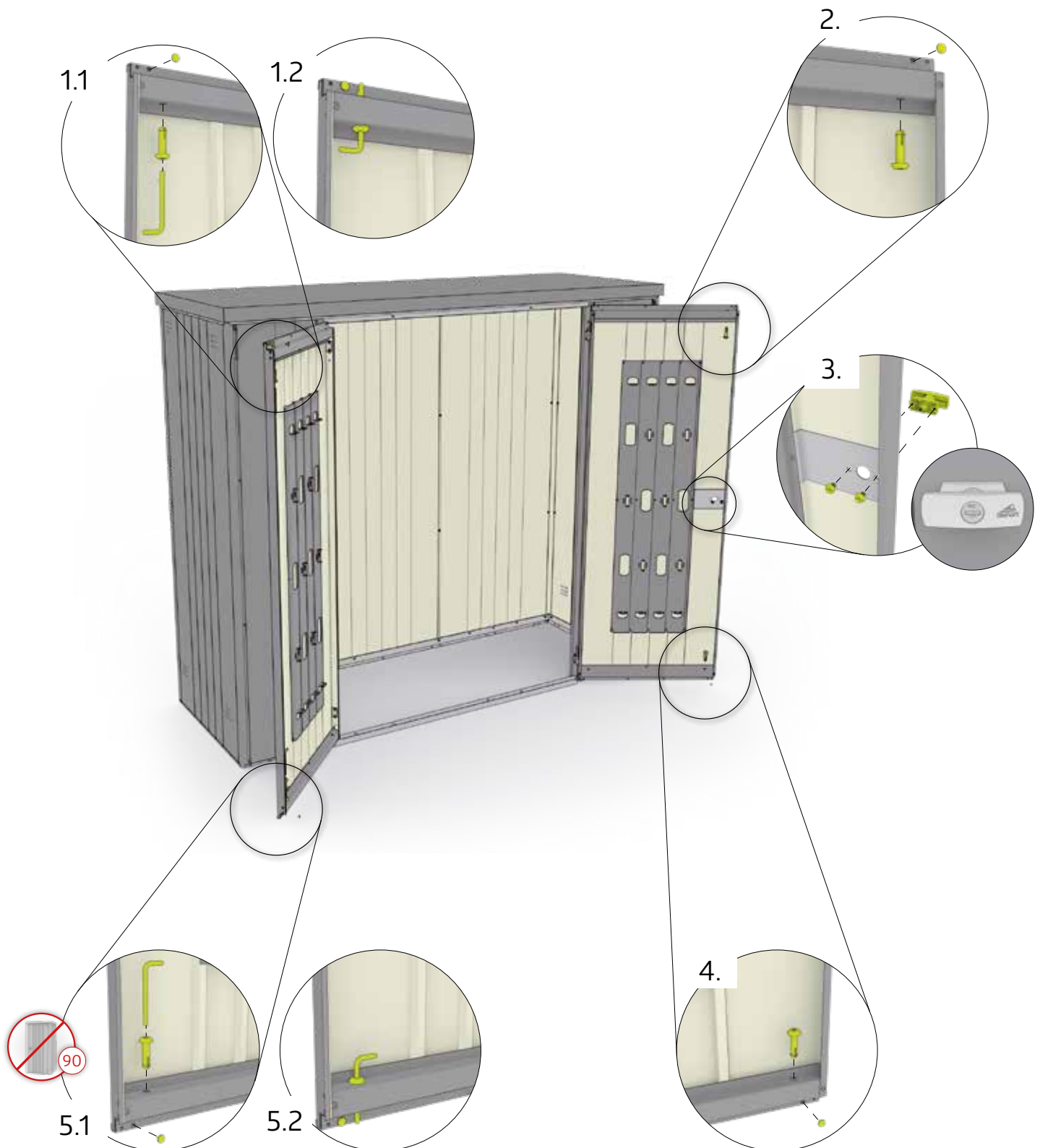

19.

 <p>(D1)</p>	<p>GS 150: 2X GS 190: 2X GS 230: 2X</p>	 <p>(D1)</p>	<p>GS 90: 2X GS 150: 4X GS 190: 4X GS 230: 4X</p>	 <p>(D1)</p>	<p>GS 90: 1X GS 150: 1X GS 190: 1X GS 230: 1X</p>
<p>M6 x 8</p>  <p>(D1)</p>	<p>GS 90: 2X GS 150: 2X GS 190: 2X GS 230: 2X</p>	 <p>(D1)</p>	<p>GS 90: 2X GS 150: 4X GS 190: 4X GS 230: 4X</p>		



 <p>(D1)</p>	GS 90: 1x	 <p>(I)</p>	GS 90: 2x	<p>M6 x 8</p>  <p>(D1)</p>	GS 90: 1x
	GS 150: 1x		GS 150: 2x		GS 150: 1x
	GS 190: 1x		GS 190: 2x		GS 190: 1x
	GS 230: 1x		GS 230: 2x		GS 190: 1x
					GS 230: 1x



JÄHRLICH ÖLEN!

- (GB) Lubricate annually
- (FR) Huiler chaque année
- (NL) Jaarlijks oliën
- (ES) Engrasar 1 vez al año
- (IT) Lubrificare una volta all'anno
- (DK) Olie årligt!
- (SE) Olja varje år!
- (NO) Olje årlig!
- (PL) Smaruj corocznie!
- (SK) Raz ročne premazať!
- (SI) Redno podmazujte!
- (CZ) Jednou ročně promazat!
- (HU) Évente olajozza be a zárát!
- (HR) Podmazujte godišnje
- (RO) Gresati anual

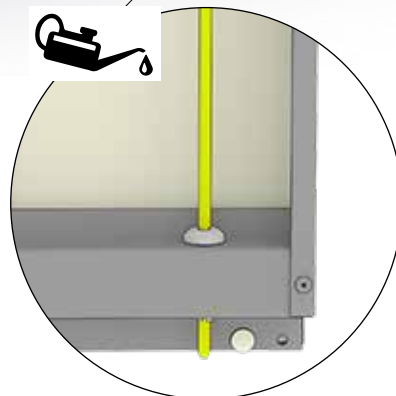
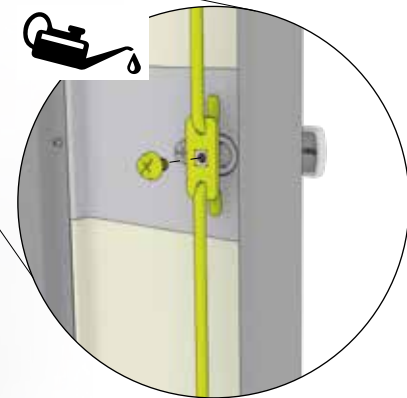
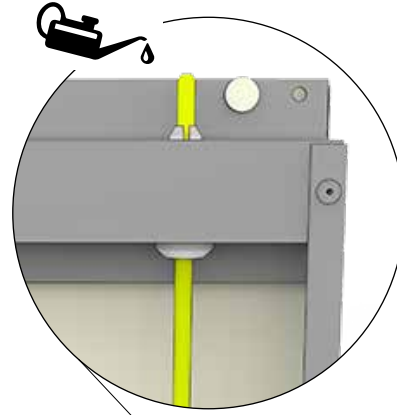
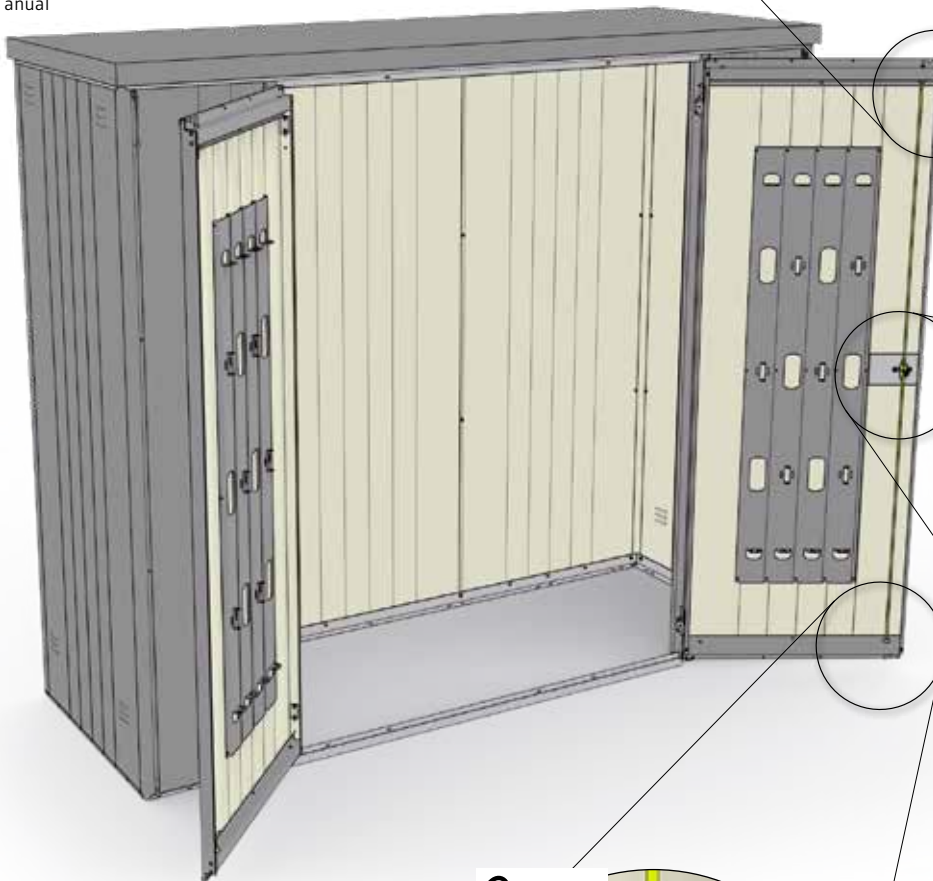

21.

	 GS 90: 1X (2850mm)		 GS 90: 1X
	GS 150: 1X (2850mm)		GS 150: 1X
	GS 190: 1X (2850mm)		GS 190: 1X
	GS 230: 1X (2850mm)		GS 230: 1X

1.

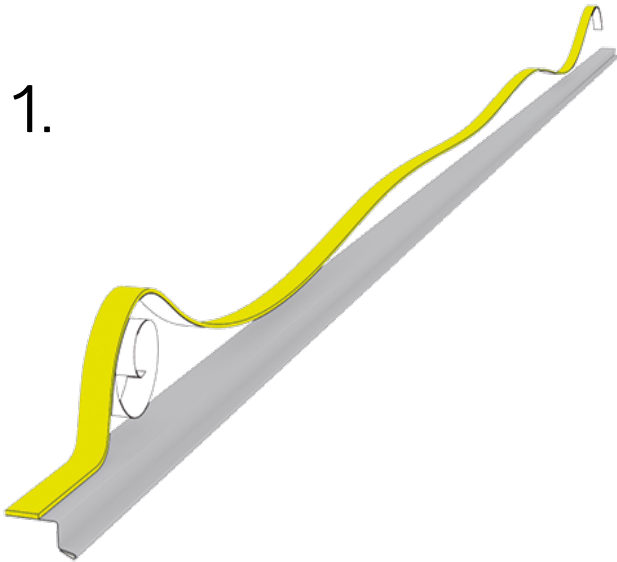

2.

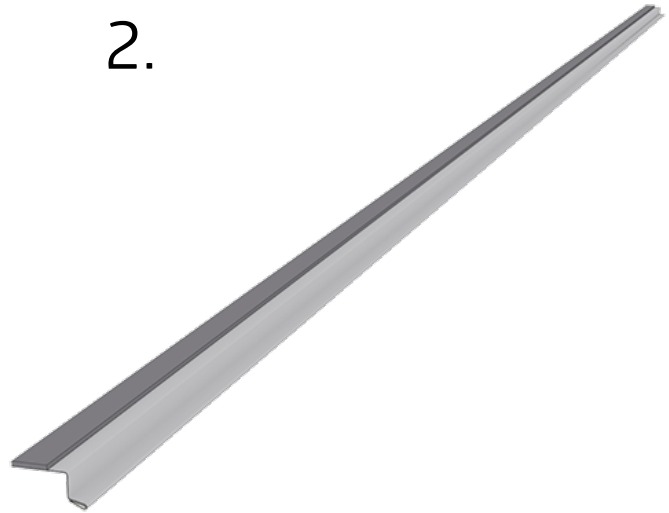

1.1

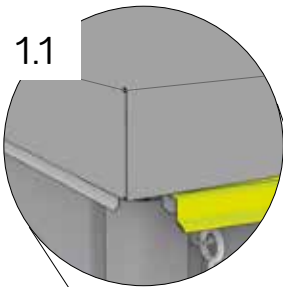

1.2



2.

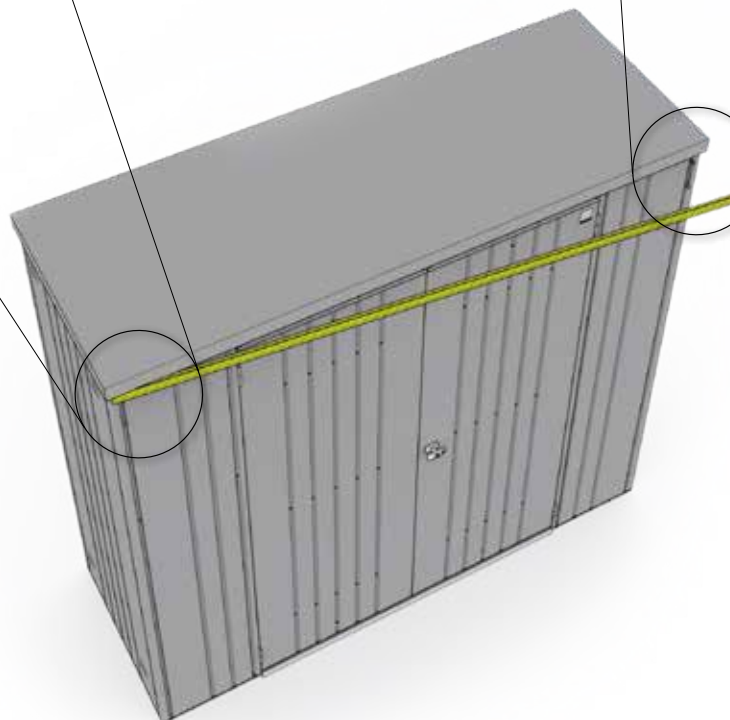
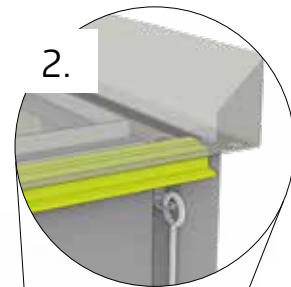

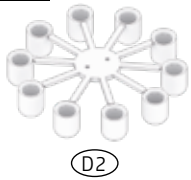

GS 90: 40x

GS 150: 70x

GS 190: 70x

GS 230: 70x

RECHTWINKELIG EINRICHTEN

- Ⓒ Set up at right angles
- Ⓕ Adjuster en forme rectangulaire
- Ⓖ Rechthoekig instellen
- Ⓔ Colóquelo en ángulo recto
- Ⓘ Installare ad angolo retto
- Ⓓ Opsættes i rette vinkler
- Ⓔ Ställ in rätt vinkel
- Ⓖ Settes opp i rett vinkel
- Ⓖ Ustawić prostopadle
- Ⓔ Zrovnať do pravého uhla
- Ⓔ Pripravite in postavite kvadrat
- Ⓔ Srovnat do pravého úhlu
- Ⓔ Derékszögbe beállítani
- Ⓔ Kvadrat osnovice
- Ⓔ Ajustat rectangular

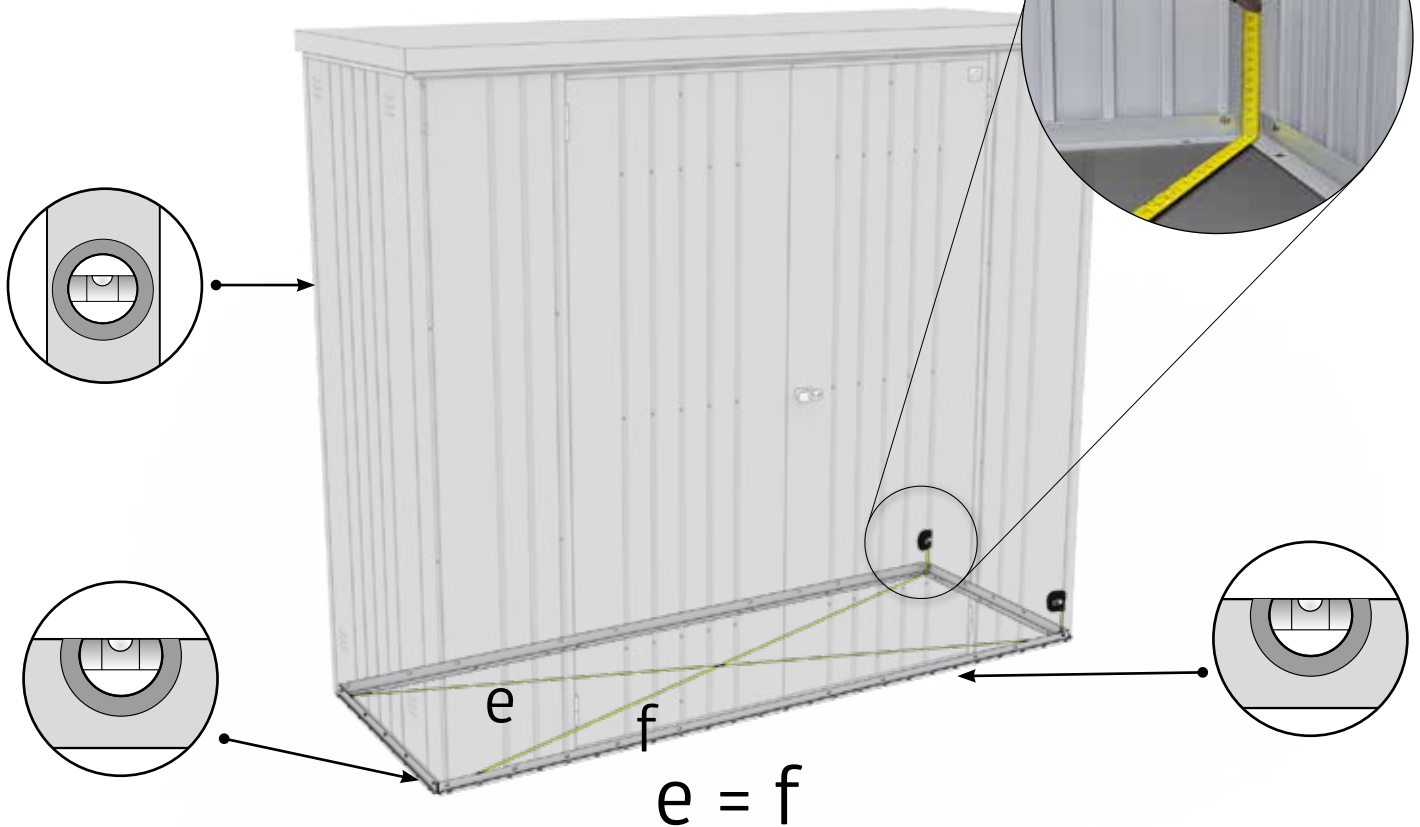

ZIEHEN SIE JETZT ALLE SCHRAUBVERBINDUNGEN FEST AN!

Tighten now all nuts and connections securely! - Serrez maintenant les vis à fond! - Draai nu alle schroeven vast! - Ahora puede apretar y fijar todos los tornillos y tuercas - Adesso serrare a fondo tutti i dadi - Fastspænd nu alle bolt-/skruerforbindelser! Dra nu åt alla skruvförband ordentligt! - Stram nå alle muttere og tilkoblinger! - Teraz dokręć wszystkie śruby - Teraz utiahnite všetky spoje! - Zdaj varno privijte vse matice in povezave! - Nyní utáhněte všechny spoje! - Most húzza meg jól az összes csavart! - Sada čvrsto zategnite sve matice i spojeve! - Strangeti acum suruburile si elementele de conectare!



TÜR EINRICHTEN

- Ⓒ Align the door
- Ⓕ Ajuster la porte
- Ⓖ Deur afstellen
- Ⓔ Ajuste la puerta
- Ⓙ Aggiustare la porta
- Ⓝ Justering af dør
- Ⓔ Justera dörren
- Ⓝ Juster døren
- Ⓟ Ustawić drzwi
- Ⓚ Porovnanie dverí
- Ⓛ Poravnajte vrata
- Ⓒ Srovnání dveří
- Ⓕ Ajtót beállítani
- Ⓕ Poravnajte vrata
- Ⓒ Aliniere usa

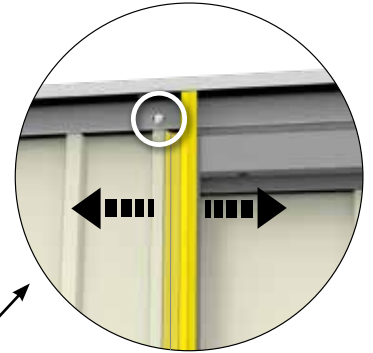
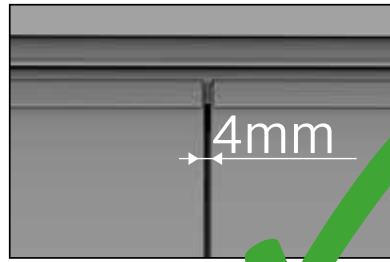

Größenabhängiger Montageschritt - Size-Dependent assembly step - Dépendant de la taille - Size-Dependent montagestep - Paso de montaje de tamaño Dependiente - Taglia-Dependent fase di montaggio - Størrelses-afhængig montage skridt - Storleksberoende monteringssteg!

Nur für Größe 90 - Only for width 90 - Juste pour la largeur de 90 - Alleen voor breedte 90 - Sólo para el ancho de 90 - Solo per larghezza 90 - Kun for størrelse 90 - Endast för storlek 90 - Bare til str 90 - Czyność tylko dla wielkości 90 - Len pre veľ. 90 - Samo za velikosti 90 - Pouze pro vel. 90 - Csak 90 méret esetén - Samo za veličine 90 - Doar pentru latimea 90

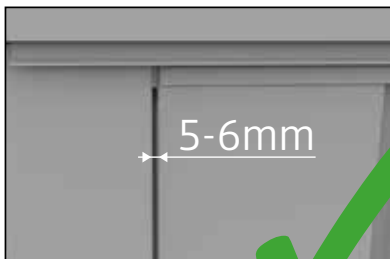

Størrelsesafhængig monteringsstrinn! - Sposób montażu zależny od wielkości. - Montážny krok závislý od veľkosti! - Korak montaže odvisen od velikosti! - Montážní krok závislý na velikosti! - Mérettől függő összeszerelési lépés! - Korak sklopa ovisno o veličini! - Pas de asamblare in functie de marime

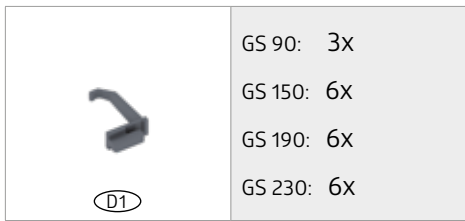

GS 90: 3X
 GS 150: 6X
 GS 190: 6X
 GS 230: 6X

FUNKTION WINDHAKEN

- Ⓒ(GB) Function of the door hooks
- Ⓒ(FR) Fonction des crochets de porte
- Ⓒ(NL) Functie van windhaken
- Ⓒ(ES) Función de los topes de seguridad
- Ⓒ(IT) Funzione gancio fermaporta
- Ⓒ(DK) Stormkrogenes funktion
- Ⓒ(SE) Funktion vindkrokar
- Ⓒ(NO) Dørkrokenes funksjon
- Ⓒ(PL) Funkcja haka wiatrowego
- Ⓒ(SK) Funkcia dverového háku
- Ⓒ(SI) Funkcija kljuk na vratih
- Ⓒ(CZ) Funkce dveřního háku
- Ⓒ(HU) Szélfogó kampó
- Ⓒ(HR) Funkcija kukica na vratima
- Ⓒ(RO) Funcția carligelor de la usa

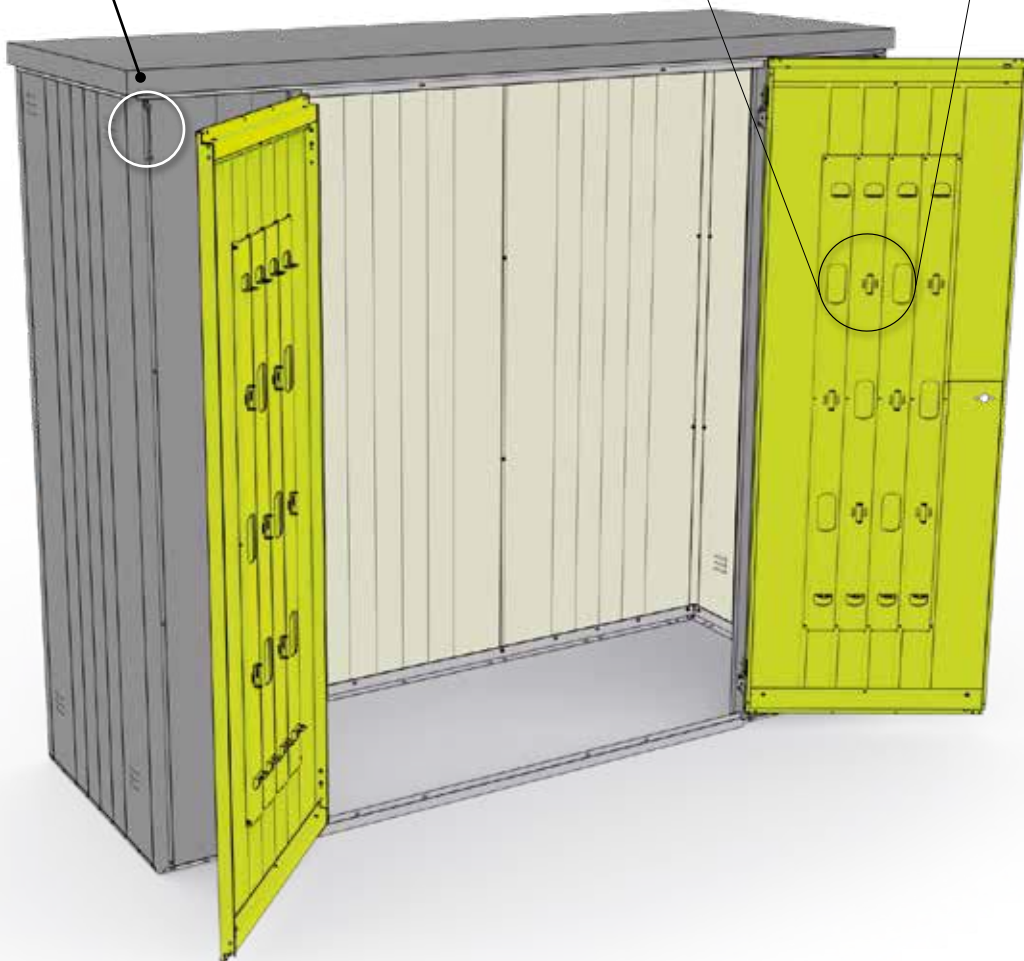
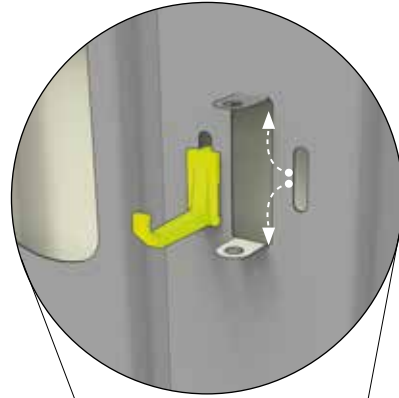
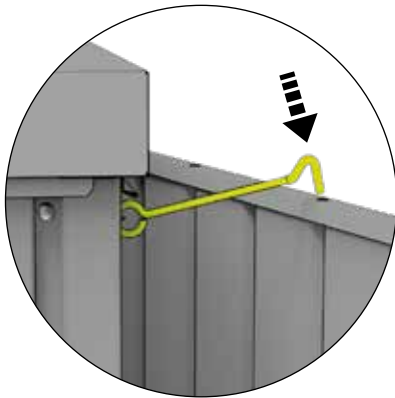



GS 90: 2X (800mm)
GS 150: 2X (1420mm)
GS 190: 2X (1780mm)
GS 230: 2X (2140mm)



GS 90: 2X (700mm)
GS 150: 2X (700mm)
GS 190: 2X (700mm)
GS 230: 2X (700mm)



GS 90: 4X
GS 150: 4X
GS 190: 4X
GS 230: 4X

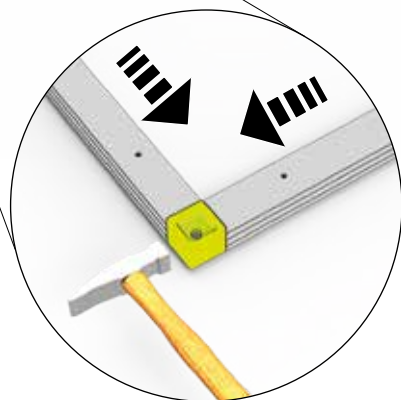



 (ZD)	GS 90: 4x	 (ZF)	GS 90: 12x
	GS 150: 4x		GS 150: 12x
	GS 190: 6x		GS 190: 12x
	GS 230: 6x		GS 230: 12x

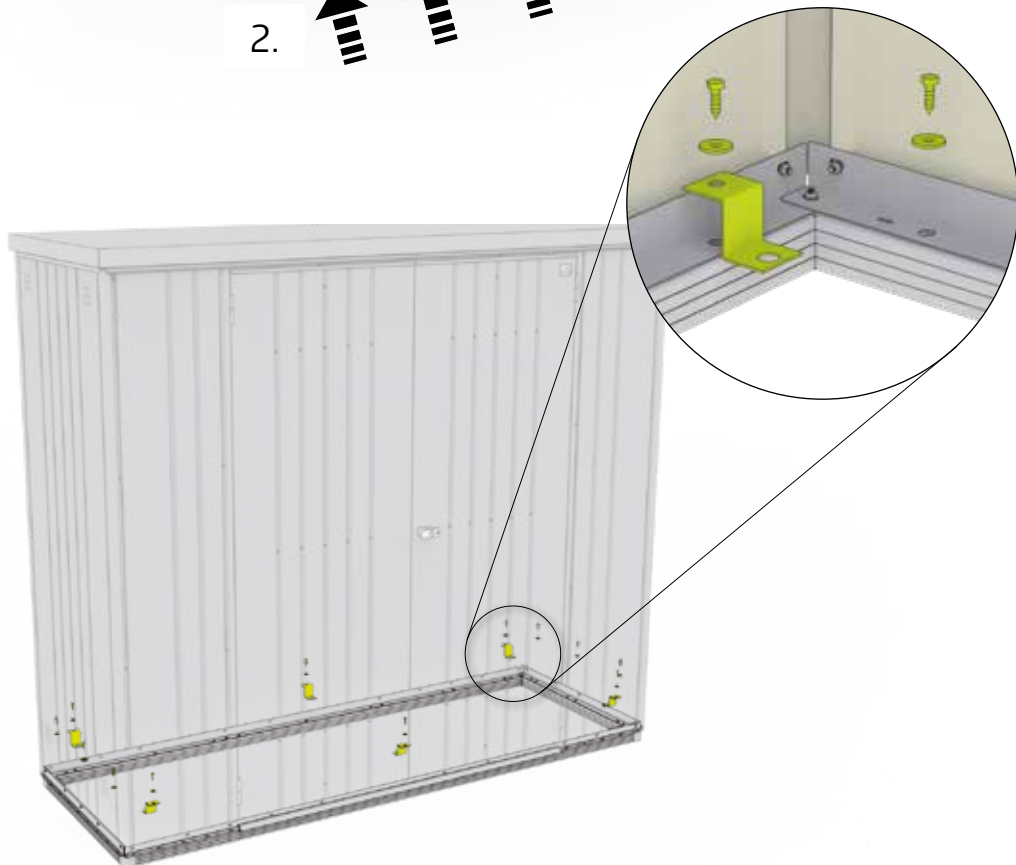
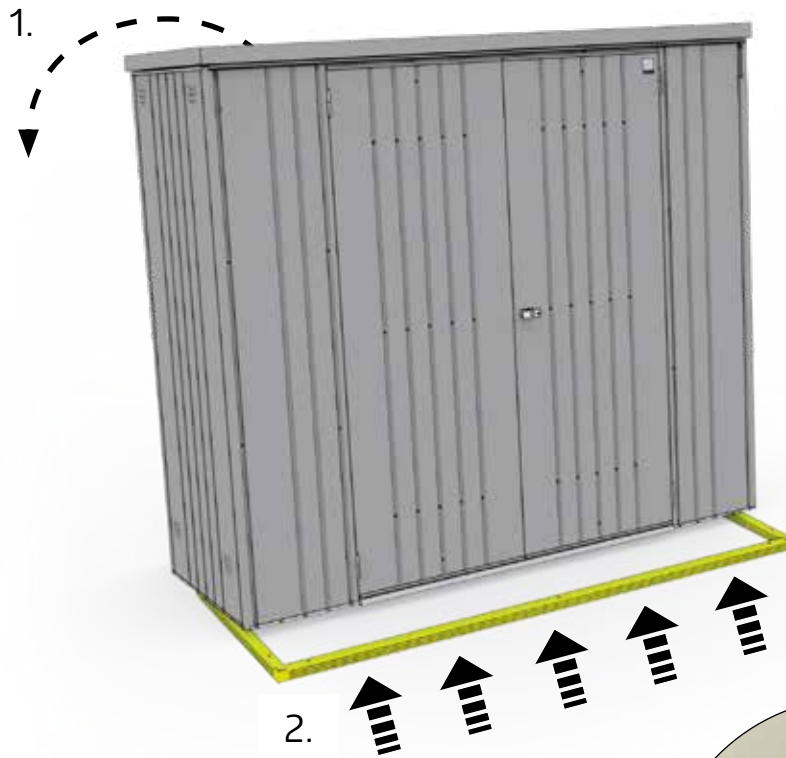



Variante 1 - Proposal 1 - Variant 1

	GS 90: 4X
	GS 150: 4X
	GS 150: 6X
	GS 230: 6X





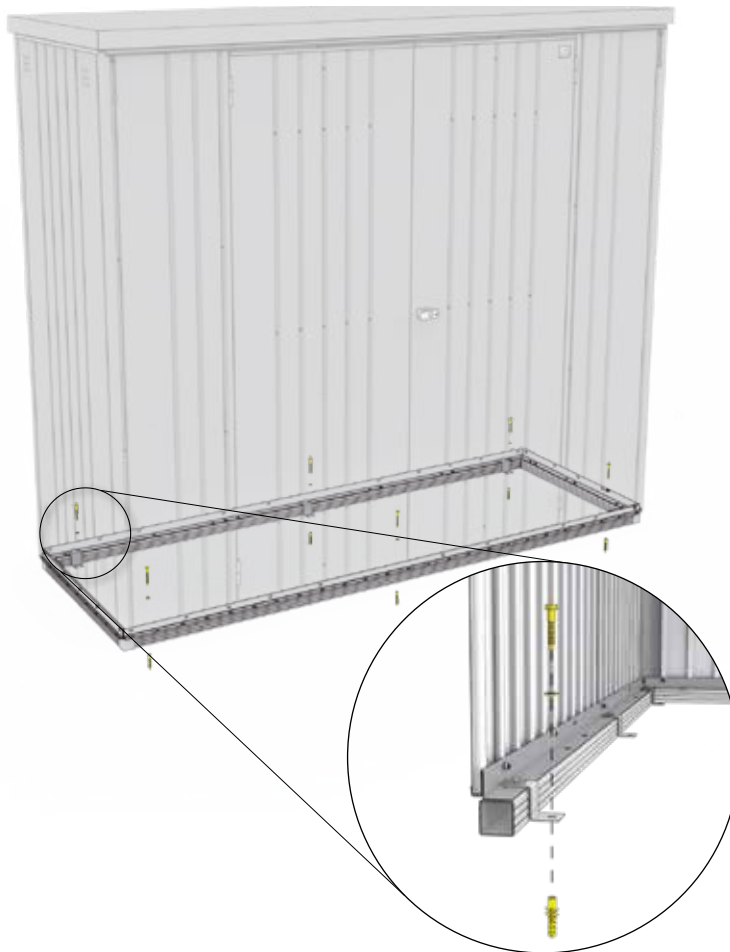
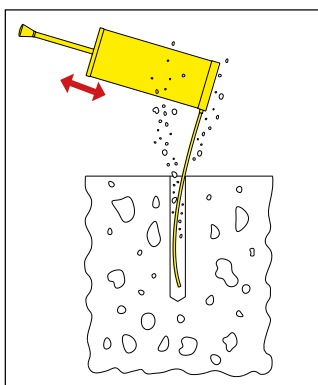
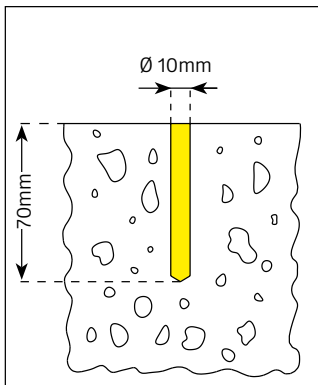

Variante 2 - Proposal 2 - Variant 2

8 x 60 	GS 90: 4X
	GS 150: 4X
	GS 190: 6X
	GS 230: 6X





24.

8 x 60 D1		GS 90: 6X
		GS 150: 6X
		GS 190: 6X
		GS 230: 6X

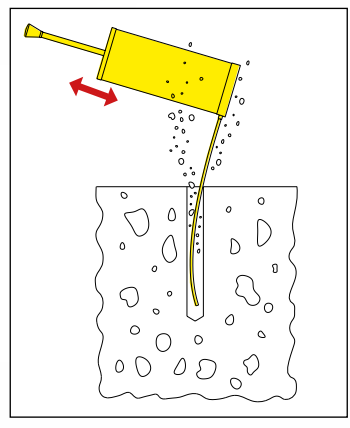
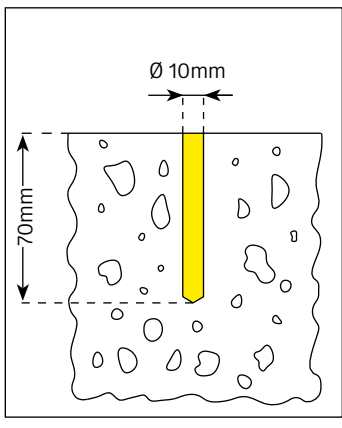
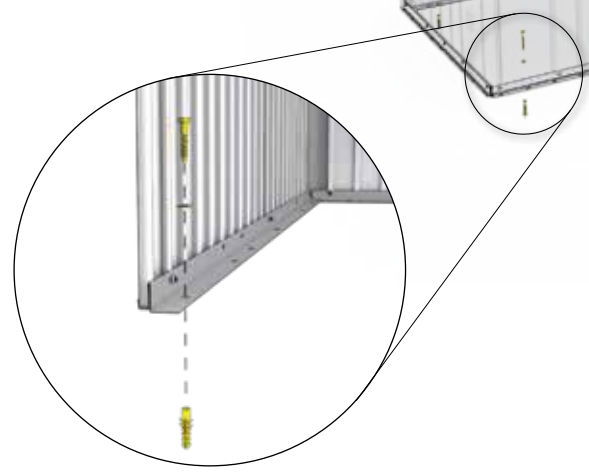
Variante 3 - Proposal 3 - Variant 3



25.

 A1		GS 90: 4X
		GS 150: 4X
		GS 190: 4X
		GS 230: 4X



KLICK



26.



GS 90: 2x

GS 150: 2x

GS 190: 2x

GS 230: 2x

®

1.

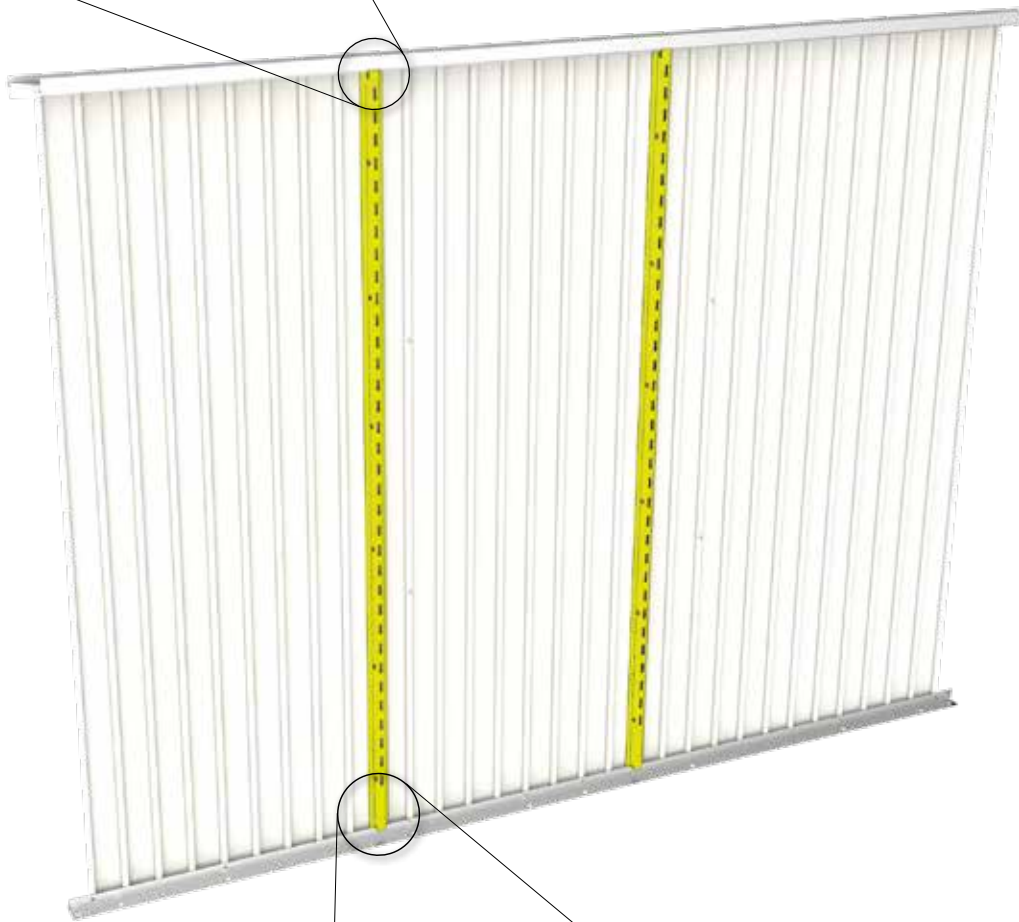
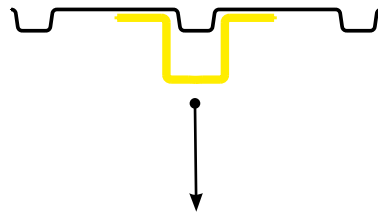
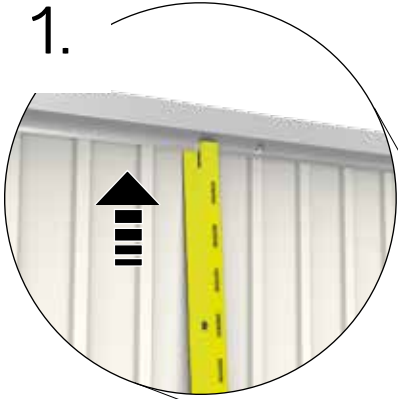

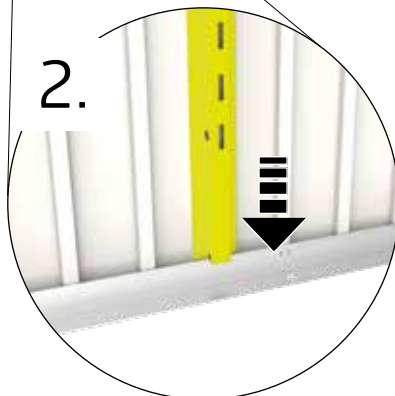

2.

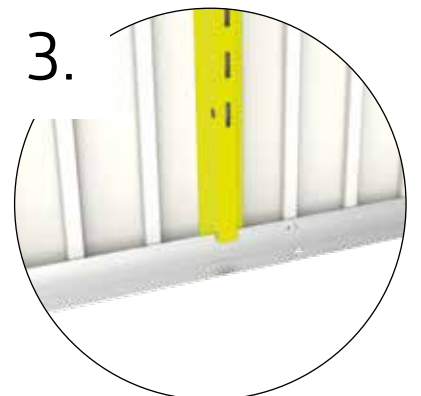

3.



	GS 90: 2x		GS 90: 4x
	GS 150: 2x		GS 150: 4x
	GS 190: 2x		GS 190: 4x
	GS 230: 2x		GS 230: 4x

Option 1:

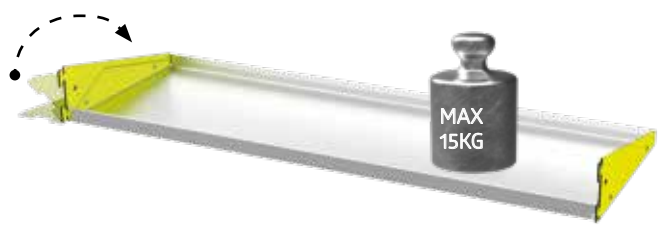

Option 2:

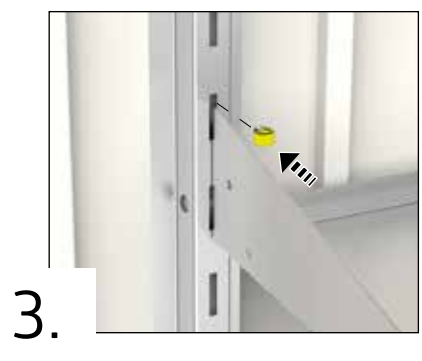
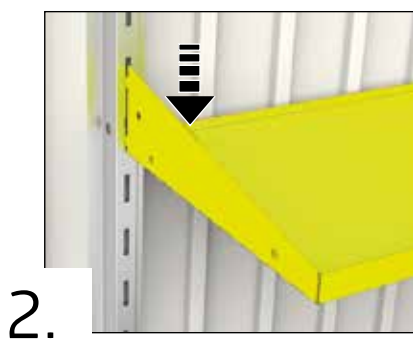
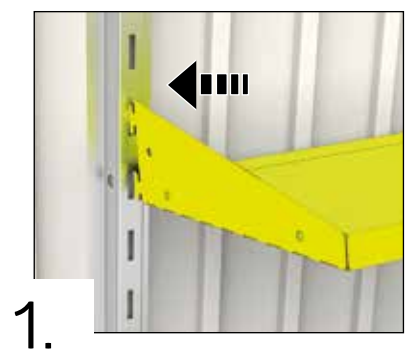
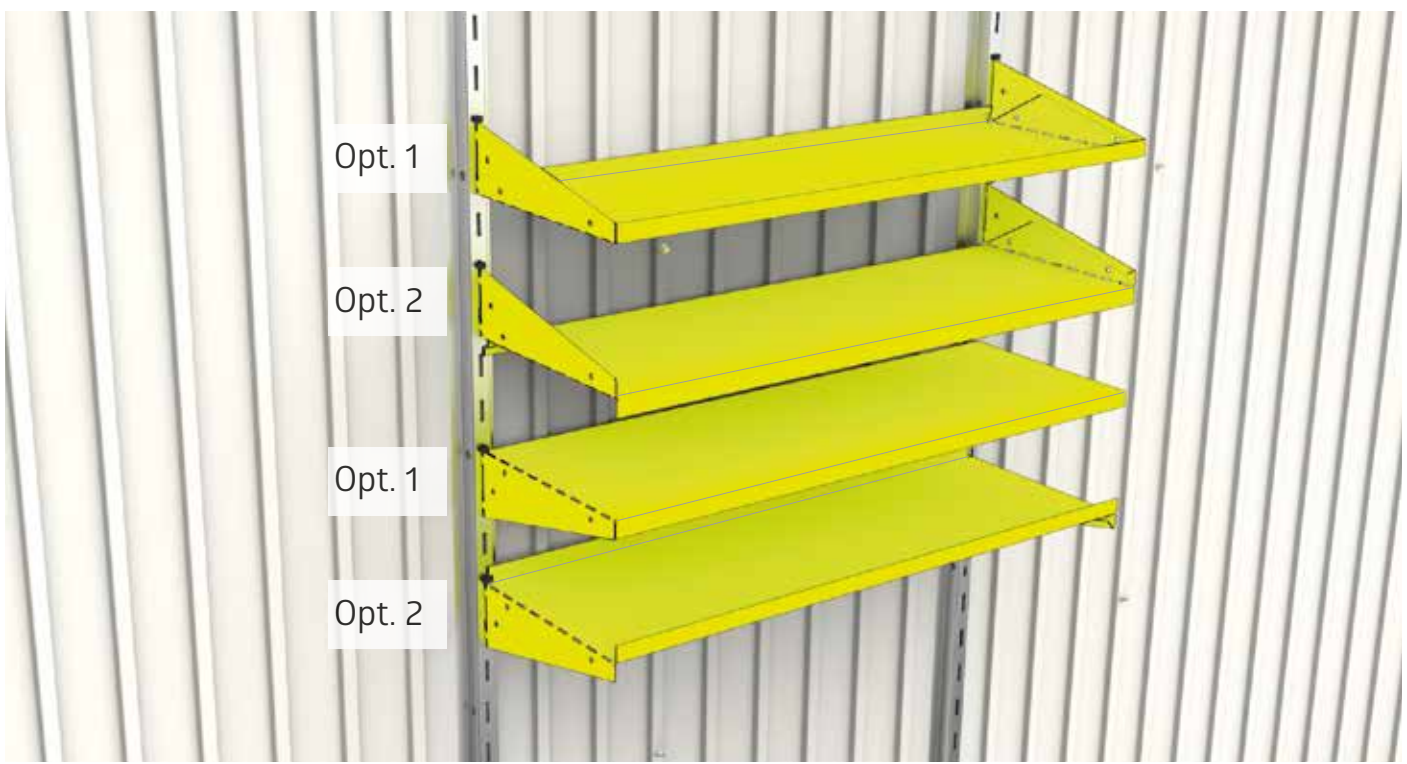



01 Gerätehalter
01 Tool Hanger



02 Regalböden / Regalsteher
02 Shelves / Support Rails



03 Haken-Set
03 Hook Set



04 Elektro-Montagepaneel
04 Electric Mounting Panel



05 LED-Leuchte
05 LED Light



06 Einhängesack
06 Suspension Basket



07 Klapptisch
07 Folding Table



GERÄTEHÄUSER – Setzen Sie auf Qualität & Langlebigkeit
GARDEN SHEDS – rely on quality & longevity



GARTENBOXEN – Outdoorboxen für Garten, Terrasse & Co.
OUTDOOR BOXES – outdoor boxes for garden, patio & etc.



FAHRRAD-GARAGEN – Fahrräder, Roller & Co. sicher verstaut
BICYCLE STORAGE – bicycles, scooters & etc. safely stowed



MÜLLTONNEN-BOXEN – Stylish, praktisch & wartungsfrei
DUSTBIN STORAGE – stylish, practical & maintenance free



GARTEN-HELFER – Gartendesign in Bestform
GARDENING HELPERS – garden design at its best



Biohort steht für
„LEBEN IM GARTEN“

Biohort stands for
„LIFE IN THE GARDEN“

follow us:

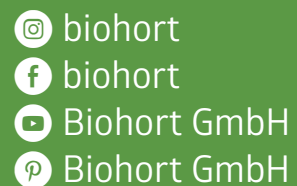

Biohort GmbH
 Pürnstein 43, 4120 Neufelden, Österreich
 +43 7282 / 7788 0
 E-Mail: office@biohort.at
 www.biohort.com



Adresses sur quefairedemesdechets.fr