

AUFBAUANLEITUNG „HighBoard 200“

- Ⓜ GB Assembly manual for “HighBoard 200”
- Ⓜ FR Notice de montage du “HighBoard 200”
- Ⓜ NL Opbouwbeschrijving voor “HighBoard 200”
- Ⓜ ES Instrucciones de montaje de “HighBoard 200”
- Ⓜ IT Istruzioni di montaggio “HighBoard 200”
- Ⓜ DK Monteringsvejledning for “HighBoard 200”
- Ⓜ SE Monteringsanvisning för “HighBoard 200”
- Ⓜ NO Monteringsveiledning for “HighBoard 200”
- Ⓜ PL Instrukcja montażu “HighBoard 200”
- Ⓜ SK Montážny návod pre “HighBoard 200”
- Ⓜ SI Priročnik za montažo “HighBoard 200”
- Ⓜ CZ Montážní manual pro “HighBoard 200”
- Ⓜ HU Felépítési útmutató “HighBoard 200”
- Ⓜ HR Priručnik za montažu za “HighBoard 200”
- Ⓜ RO Manual asamblare pentru “HighBoard 200”



WICHTIGE PUNKTE FÜR DEN AUFBAU!



VORLIEGENDE AUFBAUANLEITUNG ZEIGT DEN ZUSAMMENBAU VON HIGHBOARD „200“. FÜR EINIGE MONTAGESCHRITTE BENÖTIGEN SIE EINEN HELFER.

- GB** Important details regarding assembly! This assembly manual shows the erection of the HighBoard size "200". For several assembly steps additional assistance of one person will be required.
- FR** Points importants lors du montage! Cette notice de montage décrit l'assemblage du produit HighBoard taille « 200 ». Pour certaines étapes, demandez l'aide d'une ou deux personnes.
- NL** Belangrijke punten voor de montage! Deze montage instructies hebben betrekking op de opbouw van de HighBoard grootte 200. Bij enkele stappen tijdens de opbouw heeft u een 2e persoon nodig.
- ES** Notas importantes para el montaje: Estas instrucciones muestran el montaje del arcón HighBoard en tamaño 200. Es recomendable realizar el montaje entre dos personas.
- IT** Indicazioni importanti per il montaggio! Le seguenti istruzioni di montaggio fanno riferimento all'assemblaggio di HighBoard misura "200". Per alcune fasi di assemblaggio vi servirà qualche aiutante.
- DK** Vigtige punkter ved samling! Samlemanualen viser opsætningen af modellen HighBoard str. "200". Du skal bruge en hjælper til nogle af samlingstrinnene.
- SE** Viktiga punkter för montering! Dessa monteringsanvisningar visar hur LoungeBox® storlek "200" monteras. För vissa monteringssteg behöver du en medhjälpare.
- NO** Viktige punkter for montering! Denne monteringsanvisningen viser montering av HighBoard størrelse "200". Du trenger hjelp til noen av monteringsstrinnene.
- PL** Wskazówki dotyczące montażu. Niniejsza instrukcja wskazuje sposób montażu domku HighBoard wielkość „200”. Do wykonania niektórych czynności montażowych potrzebny będzie pomocnik.
- SK** Dôležité body pre montáž! Táto montážna príručka popisuje stavbu HighBoard veľkosti „200”. Na niekoľko montážnych krokov budete potrebovať pomocníka.
- SI** Pomembne točke za montažo! Ta priročnik za montažo prikazuje postavitev vrtno HighBoard velikosti "200". Za nekatere korake sestavljanja boste potrebovali pomočnika.
- CZ** Důležité body pro montáž! Tato montážní příručka popisuje stavbu HighBoard velikosti „200”. Pro některé kroky montáže budete potřebovat pomocníka.
- HU** Fontos információk az összeszereléshez! Ez a szerelési útmutató a HighBoard 200 összeszerelését mutatja. Néhány összeszerelési lépéshez segítségre lesz szüksége.
- HR** Važne napomene za montažu! Ovaj priručnik za montažu prikazuje postavljanje vrtno HighBoard veličine „200”. Za neke korake montaže će vam trebati pomoćnik.
- RO** Detalii importante pentru asamblare! Acest manual arata cum sa asamblati HighBoard marime "200". In mai multe momente in asamblare este necesar sa va ajute inca o persoana.

VERWENDEN SIE BEI DER MONTAGE ARBEITSHANDSCHUHE! UM KRATZER ZU VERMEIDEN, VERWENDEN SIE BITTE GEEIGNETE UNTERLAGEN!

- GB** Wear working gloves! Please use a suitable underlay to avoid scratches!
- FR** Portez des gants de travail! Pour éviter les rayures, utilisez les supports appropriés!
- NL** Handschoenen gebruiken! Om krassen te voorkomen raden wij u aan er iets onder te leggen!
- ES** Utilice unos guantes de trabajo. Por favor, coloque en el suelo una base protectora adecuada para evitar posibles arañazos.
- IT** Utilizzare guanti da lavoro. Utilizzare una base adatta per evitare graffi!
- DK** Brug arbejdshandsker! Benyt venligst et passende underlag for at undgå skrammer!
- SE** Använd arbetshandskar under monteringen! Använd lämpliga underlag för att undvika repor!
- NO** Bruk arbeidshansker! Bruk et passende underlag for å unngå riper!
- PL** Podczas montażu proszę używać rękawice ochronne. Chronić powierzchnię lakierowaną przed zarysowaniami.
- SK** Používajte pracovné rukavice! Prosím, použite vhodnú podložku, aby ste zabránili poškrábaniu!
- SI** Uporabite delovne rokavice! Uporabite ustrezno podlago, da se izognete praskam!
- CZ** Při montáži použijte pracovní rukavice! Použijte vhodné podložky, abyste se vyhnuli poškrábání!
- HU** Szerelésnél használjon védőkesztyűt! A karcolások elkerülése érdekében használjon megfelelő alátétet!
- HR** Nosite radne rukavice! Upotrijebite odgovarajuće podlago, da se izognete praskam!
- RO** Purtati manusile de protectie! Va rog sa folositi o baza potrivita pentru a evita zgarieturile!

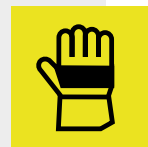

ACHTEN SIE AUF EINE STURMSICHERE BODENVERANKERUNG UND VERSPERREN SIE TÜREN/DECKEL! NICHT BEI WIND AUFBAUEN!

- (GB)** Please make sure the product is anchored in a storm-proof manner and lock the doors/lid! Do not assembly in windy condition!
- (FR)** Veillez à ce que le sol soit ancré de manière à résister aux tempêtes et verrouillez les portes/couvercles ! Ne pas procéder au montage dans des conditions venteuses !
- (NL)** Zorg voor een stormbestendige bodem verankering en vergrendel de deuren/deksel! Niet opbouwen in winderige omstandigheden!
- (ES)** Asegúrese de que el suelo cuente con un anclaje a prueba de tormentas y cierre las puertas/tapas. ¡No se instalen en condiciones de viento!
- (IT)** Assicuratevi che il pavimento sia ancorato a prova di tempesta e chiudete a chiave le porte/coperchio! Non montare in condizioni di vento!
- (DK)** Vær opmærksom på at produktet forankres stormsikkert samt at dør/låg er aflåst! Bør ikke monteres ved kraftig vind!
- (SE)** Se till att markförankringen är stormsäker och lås dörrar! Genomför inte monteringen när det blåser!
- (NO)** Forsikre deg om at produktet er ordentlig forankret på en storm sikker måte og lås dørene / lokket! Ikke monter når det blåser mye!
- (PL)** Zwróć uwagę na wiatroodporne zakotwiczenie w ziemi i zamykaj drzwi/pokrywy! Nie montować przy silnym wietrze!
- (SK)** Dbajte na podlahové ukotvenie proti víchrici a zaistite dvere/ poklop! Nerobte montáž pri vetre!
- (SI)** Prepričajte se, da je izdelek zasidran zaradi neviht in zaklepajte vrata / pokrov! Ne sestavljajte v vetrovnem stanju!
- (CZ)** Zkontrolujte podlahové ukotvení odolné proti bouři a zamkněte dveře/víka! Nenechávejte ve větru otevřené a nezajištěné!
- (HU)** Figyeljen a padló viharbiztos rögzítésére, valamint az ajtók és a tető zárhatóságára! Ne szélben építse fel!
- (HR)** Molimo osigurajte da je proizvod usidren na oluju i zaključajte vrata / poklopac! Ne montirajte u vjetrovitom stanju!
- (RO)** Sa va asigurati ca produsul este ancorat corespunzator si incuiati usa/capacul! Nu asamblati daca bate vantul!



WASSERWAAGEN - SYMBOL!

Betreffendes Einbauteil mit der Wasserwaage ausrichten.

- (GB)** Symbol of spirit level: Align the respective parts by using the spirit level.
- (FR)** Symbole niveau à bulle: Lorsque ce symbole apparaît, vous devez ajuster l'élément à l'aide d'un niveau à bulle.
- (NL)** Waterpas – symbool: Bij montageschappen waar dit symbool bijstaat is het noodzakelijk het betreffende onderdeel waterpas in te bouwen.
- (ES)** Símbolo del nivelador: Indica que se debe ajustar y centrar la pieza con la ayuda de un nivelador.
- (IT)** Simbolo di livella a bolla d'aria: Allineare il componente in questione con l'ausilio di una livella a bolla d'aria.
- (DK)** Symbol for vaterpas: Juster de respektive dele ved hjælp af vaterpas.
- (SE)** Vattenpassymbol: Rikta in relevant installationsdel med vattenpasset.
- (NO)** Symbol på vater: Juster de respektive delene ved å bruke et vater.
- (PL)** Symbol poziomicy - element wypoziomować.
- (SK)** Symbol vodováhy: Vyrovnajte príslušnej časti pomocou vodováhy.
- (SI)** Simbol vodne tehtnice: Poravnajte ustrezne dele z uporabo vodne tehtnice.
- (CZ)** Symbol vodováhy: Vyrovnajte příslušné části pomocí vodováhy.
- (HU)** Vízmérték – szimbólum: A szükséges elem beállításához használgon vízmértéket.
- (HR)** Simbol libele: Poravnajte odgovarajuće dijelove pomoću libele.
- (RO)** Simbol nivela: Aliniați partile folosind nivela.

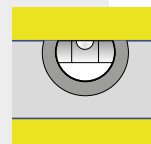

OPTIONALES ZUBEHÖR - SYMBOL!

Arbeitsschritte, die blau eingerahmt sind, zeigen den Einbau eines optionalen Zubehörteiles.

- (GB)** Symbol of optional accessories: Blue framed assembly steps show the installation of optional accessories.
- (FR)** Accessoires en option-Symbole: La trame entourée en bleu indique une étape avec accessoires en option. A réaliser uniquement si vous avez commandé cet accessoire.
- (NL)** Extra Toebehoor: Montageschappen met een blauwe rand betreffen de inbouw van extra toebehoor.
- (ES)** Accesorio opcional – símbolo: Los pasos de montaje que se encuentran enmarcados en azul muestran el montaje de una pieza de un accesorio opcional.
- (IT)** Simbolo per accessori opzionali: Le fasi del montaggio incorniciate in colore azzurro mostrano l'installazione di un accessorio opzionale.
- (DK)** Symbol for ekstra udstyr: Blåt indrammet samletrin viser installationen af ekstraudstyr
- (SE)** Symbol för extra tillbehör: Arbetssteg som är inramade i blått visar hur ett valfritt tillbehör installeras.
- (NO)** Symbol for tilleggsutstyr: Blå inrammede monteringsstrinn viser installasjonen av ekstrautstyr.
- (PL)** Wyposażenie dodatkowe - symbol: Czynności w niebieskiej ramce dotyczą elementów wyposażenia dodatkowego.
- (SK)** Symbol voliteľného príslušenstva: Montážne kroky v modrom rámečku ukazujú inštaláciu voliteľného príslušenstva.
- (SI)** Simbol dodatne opreme: Montažni koraki v modrem okvirju prikazujejo namestitve dodatne opreme.
- (CZ)** Symbol volitelného příslušenství: Montážní kroky v modrém rámečku ukazují instalaci volitelného příslušenství.
- (HU)** Opcionális tartozék – szimbólum: A kékkel bekeretezett munkafolyamatok az opcionális tartozék beépítését jelölik.
- (HR)** Simbol dodatne opreme: Montažni koraci u plavom okviru ukazuju na ugradnju dodatne opreme.
- (RO)** Simbol accesorii optionale: Pasii de asamblare marcate cu albastru indica instalarea accesorilor optionale.

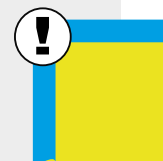

ACHTUNG: IM SOMMER KÖNNEN IM INNENRAUM SEHR HOHE TEMPERATUREN ENTSTEHEN!

- (GB)** Attention: during the summer high temperature might arise in the interior.
- (FR)** Attention: En été la température à l'intérieur de l'abri peut être élevée!
- (NL)** Let op: in de zomer kunnen in de berging zeer hoge temperaturen bereikt worden.
- (ES)** Tenga en cuenta que en el verano las temperaturas en el interior pueden ser altas.
- (IT)** I dadi devono essere serrati a fondo soltanto alla fine del montaggio!
- (DK)** Attention: Si prega di prendere nota che in estate si possono essere temperature molto elevate all'interno.
- (SE)** På sommaren kan mycket höga temperaturer uppstå inne i redskapsboden!
- (NO)** OBS: om sommeren kan det oppstå høy temperatur inne i produktet.
- (PL)** Uwaga: latem temperatura wewnątrz może wysoko wzrosnąć!
- (SK)** Pozor: v lete môže v interiéri dôjsť k zvýšeniu teploty.
- (SI)** Pozor: poleti se lahko v notranjosti pojavi visoka temperatura.
- (CZ)** Pozor: v létě může v interiéru dojít ke zvýšení teploty.
- (HU)** FIGYELEM: Nyáron a tárolók belsejében nagyon magas lehet a hőmérséklet!
- (HR)** Pažnja: tijekom ljeta u unutrašnjosti se može pojaviti visoka temperatura.
- (RO)** Atentie: in timpul verii in interior temperatura poate fi ridicata.

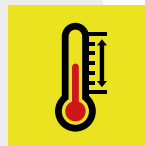

MASSTABSGETREUE ABBILDUNGEN DER ZU VERWENDENDEN SCHRAUBEN! (M 1:1)

- (GB)** Scale drawing 1:1 of the screws in use
- (FR)** Reproduction selon l'échelle 1:1.
- (NL)** Afbeelding : schaal 1:1 (ware grootte)
- (ES)** Reproducción a escala 1:1 de los tornillos que se utilizan para el montaje.
- (IT)** Immagine in scala delle viti da utilizzare!
- (DK)** Skala tegning af skruer er 1:1
- (SE)** Skalenliga ritningar av skruvarna som ska användas:
- (NO)** Måltegning 1: 1 av skruene som er i bruk
- (PL)** Skalowane ilustracje używanych śrub:
- (SK)** Mierka výkresu 1: 1 použitých skrutiek
- (SI)** Risba v merilu 1: 1 uporabljenih vijakov
- (CZ)** Měřitko výkresu 1: 1 použitých šroubů
- (HU)** A felhasználandó csavarok méretarányos ábrái:
- (HR)** Crtež veličine 1: 1 vijaka koji se koriste
- (RO)** Scala desenului pentru suruburi este 1:1

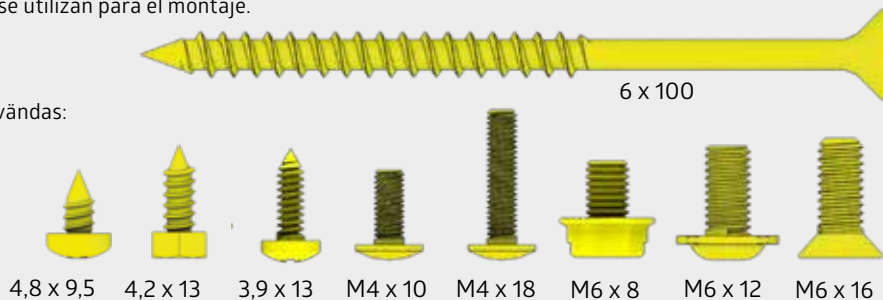

SCHRAUBVERBINDUNGEN GRUNDSÄTZLICH ERST AM ENDE DER MONTAGE FESTZIEHEN!

- (GB)** Nuts not to be tightened before the end of assembly!
- (FR)** Ne serrer les écrous à fond qu'à la fin du montage!.
- (NL)** Schroeven pas aan het einde van de montage vastdraaien!
- (ES)** En principio, no apriete fijamente las tuercas hasta que no haya terminado de montar la caseta.
- (IT)** I dadi devono essere serrati a fondo soltanto alla fine del montaggio!
- (DK)** Møtrikkerne må ikke strammes før slutningen af opsætningen!
- (SE)** Dra alltid åt skruvförbanden först i slutet av monteringen!
- (NO)** Muttere som ikke skal strammes til før monteringen er ferdig!
- (PL)** Śruby dokręcić ostatecznie dopiero po zakończeniu montażu.
- (SK)** Matica dotahujte až pred koncom montáže!
- (SI)** Matic ne privijte pred koncem montáže!
- (CZ)** Matice dotahujte až před koncem montáže!
- (HU)** A csavarokat mindig csak az összeszerelés végén kell erősen meghúzni!
- (HR)** Matice ne treba stezati prije kraja montáže!
- (RO)** Piulitele nu trebuie stranse înainte de sfarsitul montajului!

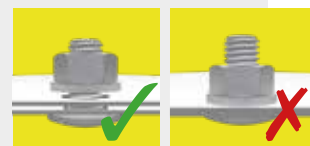

KEINE ABDECKUNG/HÜLLE FÜR DAS PRODUKT VERWENDEN!

- (GB)** Do not use a cover for the product!
- (FR)** Ne pas couvrir le produit, ne pas utiliser de housse.
- (NL)** Gebruik geen afdekhoes voor het product!
- (ES)** No utilice una cubierta/manga para el producto.
- (IT)** Non utilizzare una copertura/manica per il prodotto!
- (DK)** Brug ikke et dæksel/overtræk til produktet!
- (SE)** Använd inte lock/hölje för produkten!
- (NO)** Ikke bruk et deksel/omslag til produktet!
- (PL)** Nie używaj pokrowca ochronnego na produkt!
- (SK)** Nepoužívajte kryt pre tento produkt!
- (SI)** Ne uporabljajte prevleke/tulca za izdelek!
- (CZ)** Nepoužívejte kryt pro tento produkt!
- (HU)** Ne használjon semmilyen takartó,- vagy burkolóanyagot a termékhez!
- (HR)** Ne koristite pokrov/rukav za proizvod!
- (RO)** Nu acoperiti produsul!

HALTEN SIE WÄHREND DES ZUSAMMENBAUS ALLE MITGELIEFERTEN KLEINTEILE ODER VERPACKUNGSMATERIALIEN FERN VON KLEINKINDERN!

Bauteile weisen scharfe Kanten auf oder stehen vor, achten Sie während der Montage und bei der täglichen Nutzung darauf.

- (GB)** Keep all supplied small parts or packaging materials away from small children during assembly. Components have sharp edges or protrude, pay attention to them during assembly and during daily use.
- (FR)** Gardez toutes les petites pièces ou les matériaux d'emballage fournis hors de portée des enfants pendant le montage. Les pièces d'assemblage peuvent être tranchantes, faites-y attention lors de l'assemblage et de l'utilisation quotidienne.
- (NL)** Houd alle kleine onderdelen of verpakkingsmaterialen die worden mee geleverd uit de buurt van kleine kinderen tijdens de montage. Onderdelen hebben scherpe randen of steken uit, let op bij de montage en bij het dagelijks gebruik.
- (ES)** Mantenga todas las piezas pequeñas o materiales de embalaje suministrados lejos de los niños durante el montaje. Los componentes tienen bordes afilados o salientes, preste atención a ellos durante el montaje y durante el uso diario.
- (IT)** Tenere tutte le piccole parti o i materiali d'imballaggio forniti lontano dalla portata dei bambini durante il montaggio. I componenti hanno spigoli vivi o sporgenti, prestare attenzione ad essi durante il montaggio e durante l'uso quotidiano.
- (DK)** Hold alle leverede smådele og emballage utilgængeligt for børn under montagen. Komponenter har skarpe kanter eller stikker ud, vær opmærksom på dem under montering og under daglig brug.
- (SE)** Håll alla medföljande smådelar och förpackningsmaterial borta från småbarn under monteringen. Komponenterna kan ha vassa kanter eller utstickande delar, var uppmärksam på detta vid montering och daglig användning.
- (NO)** OBS: Hold alle smådeler og emballasjemateriale borte fra små barn under montering. Komponentene har skarpe kanter eller noe som stikker ut, vær oppmerksom på dette under monteringen og under den daglig bruken.
- (PL)** ZACHOWAJ WSZYSTKIE MAŁE CZĘŚCI PODCZAS MONTAŻU LUB MATERIAŁY OPAKOWANIA Z DALA OD MAŁYCH DZIECI. Elementy mają ostre lub wystające krawędzie, należy zwracać na to uwagę podczas montażu i codziennego użytkowania.
- (SK)** Udržujte počas montáže všetky dodané malé diely a obalové materiály mimo dosahu malých detí. Komponenty majú ostré hrany alebo vyčnievajúce časti. Dbajte na to počas montáže a každodenného používania.
- (SI)** POZOR: Med montažo naj bodo vsi dobavljeni majhni deli ali embalažni materiali oddaljeni od majhnih otrok. Sestavni deli imajo ostre robove ali pa štrlijo, bodite pozorni nanje med sestavljanjem in med vsakodnevno uporabo.
- (CZ)** Během montáže udržujte všechny malé dodávané díly nebo obalové materiály mimo dosah malých dětí. Díly mají ostré hrany nebo vyčnívají, věnujte jim pozornost při montáži a každodenním používání, aby nedošlo k úrazu.
- (HU)** Az összeszerelés során kisgyerekektől tartsa távol az apró alkatrészeket valamint a csomagolóanyagokat. A szerelés és a napi használat során ügyeljen az éles szélekre valamint a kiálló részekre.
- (HR)** PAŽNJA: Tijekom montaže držite sve isporučene male dijelove ili materijale za pakiranje podalje od male djece. Sastavni dijelovi imaju oštre rubove ili strše, obratite pažnju na njih tijekom montaže i tijekom svakodnevnog uporabe.
- (RO)** Nu lasati piesele mici sau ambalajul la indemana copiilor. Componentele au margini taioase sau inteapa, aveti grija in timpul asamblării si in timpul folosirii zilnice.

UMGANG MIT BESCHÄDIGTEN TEILEN!

Verbauen Sie keine beschädigten Teile! Falls Sie Beschädigungen feststellen, müssen diese vorab inkl. aussagekräftiger Bilder an uns gemeldet werden. Durch den Verbau gelten die Teile als akzeptiert.

- (GB)** Handling of damaged parts: Do not install damaged parts! If you note damages, they must be reported to us in advance, including meaningful pictures. The parts are considered accepted by the installation.
- (FR)** Manipulation des pièces endommagées: N'installez pas de pièces endommagées ! Si vous découvrez des dommages, vous devez nous en informer à l'avance, en nous envoyant des photos significatives. Après le montage, les pièces sont considérées comme acceptées.
- (NL)** Omgaan met beschadigde onderdelen: Monteer géén beschadigde onderdelen! Als u schade ontdekt, moet dit vooraf aan ons worden gemeld, inclusief duidelijke foto's. Als u de beschadigde onderdelen toch monteert, dan heeft u hiermee het product "geaccepteerd".
- (ES)** Manejo de partes dañadas: Por favor, NO instale partes dañadas, Si descubre algún daño, debe informarnos con antelación, incluyendo fotos claras de los daños. Las piezas se consideran aceptadas si se realiza su la instalación.
- (IT)** Gestione di parti danneggiate: Non installare parti danneggiate! Se si rivela un danno, questo deve essere segnalato in anticipo per mail con materiale fotografico a supporto del reclamo. Se si procede all'installazione delle parti danneggiate, Biohort si riserva il diritto di respingere il reclamo.
- (DK)** Håndtering af beskadigede dele: Brug ikke beskadigede dele! Hvis du opdager nogen skade, skal dette rapporteres til os på forhånd, herunder meningsfulde billeder. Dele betragtes som accepteret gennem installationen.
- (SE)** Hantering av skadade delar: Använd inte skadade delar! Om du upptäcker några skador måste detta rapporteras till oss i förväg, inklusive meningsfulla bilder. Delarna anses accepterade när de installeras.
- (NO)** Håndtering av ødelagte deler: Ikke monter ødelagte deler! Hvis du registrerer skader, må du rapportere dette til oss, og sende bilder av de skadde delene. Hvis skadde deler blir montert, anses de som akseptert av montøren.
- (PL)** POSTĘPOWANIE Z USZKODZONYMI CZĘŚCIAMI Nie używaj uszkodzonych części! W przypadku stwierdzenia jakichkolwiek uszkodzeń należy je zgłosić wraz ze szczegółowymi zdjęciami. Elementy uszkodzone zainstalowane uważane są za zaakceptowane.
- (SK)** Zaobchádzanie s poškodenými dielmi: V prípade že zistíte nejaké poškodenia, musia nám byť tieto nahlásené aj s príslušnými fotografiami. V prípade zabudovania budú diely považované za akceptované.
- (SI)** Ravnanje s poškodovanimi deli: Poškodovanih delov ne nameščajte! Če opazite škodo, nam je to treba sporočiti vnaprej, vključno s slikami. Namestitev šteje, kot da so deli sprejeti.
- (CZ)** Manipulace s poškozenými částmi: Pokud zjistíte poškození, musíte nám to nahlásit předem, včetně průkazných obrázků. Díly jsou považovány za přijaté jejich instalací.
- (HU)** A sérült alkatrészek kezelése: Ha bármilyen sérülést észlel, a sérült elemeket képekel igazolva jeleni kell felénk. A beépítéssel, az elemeket elfogadottnak tekintjük.
- (HR)** Rukovanje oštećenim dijelovima: Nemojte postavljati oštećene dijelove! Ako primijetite štetu, morate nam je prijaviti unaprijed, uključujući značajne slike. Instalacija smatra da su dijelovi prihvaćeni.
- (RO)** Manipularea pieselor deteriorate: Nu instalati piesele deteriorate! Dacă observati deteriorari, trebuie sa ne anuntati inainte de asamblare, impreuna cu fotografii clare. Dacă le asamblati se considera acceptate.

PFLEGE UND WARTUNG!

Keine aggressiven Chemikalien wie z.B. Chlor oder Streusalz lagern!

Sonnenmilch und andere Cremes mit Wasser und Seife entfernen.

Keine scheuernden Reinigungsmittel verwenden!

Ölen Sie das Schloss jährlich!

Schraubverbindungen regelmäßig kontrollieren!

- (GB)** Care and maintenance: Do not store aggressive substances i.e. chlorine or road salt! Remove suntan lotion or any other creams with soap and water! Do not use abrasive cleaning agents! Lubricate the lock once a year! Check screw connections regularly!
- (FR)** Entretien et maintenance: Ne pas stocker de produits chimiques (chlore, sel, etc...)! Nettoyez uniquement avec de l'eau les crèmes solaires et autres crèmes (pas de nettoyant chimique). Ne pas utiliser de produits nettoyant abrasifs! Graissez la serrure et les charnières chaque année! Vérifiez régulièrement les raccords à vis!
- (NL)** Onderhoud: Geen chemicaliën in de berging opslaan! Zonnebrandolie/melk en andere cremes met water en glansmiddel verwijderen. Gebruik geen schuurmiddelen! Slot jaarlijks oliën. Controleer regelmatig de schroefverbindingen!
- (ES)** Cuidado y mantenimiento: No almacene productos químicos agresivos dentro de la caseta como por ejemplo cloro y sal antiescarcha. Evite dejar huellas o restos de cremas solares sobre la chapa. Limpie la caseta siempre con agua y jabón. No utilice ningún producto para fregar. Aplique aceite en la cerradura y las bisagras una vez al año. ¡Compruebe las conexiones de los tornillos regularmente!
- (IT)** Manutenzione: Non lasciare prodotti chimici aggressivi (come ad esempio cloro o sale per strade) all'interno della casetta! Rimuovere crema solare e altre creme con acqua e brillantante! Non utilizzare detergenti contenenti sostanze aggressive! Lubrificare la serratura e le cerniere a cadenza annuale! Controllare regolarmente i collegamenti a vite!
- (DK)** Rimuovere crema solare e altre creme con acqua e brillantante! Non utilizzare detergenti contenenti sostanze aggressive! Pleje og vedligeholdelse: Opbevar ikke aggressive stoffer dvs. Klor eller vejsalt! Fjern solcreme eller andre typer af creme med vand og rensmiddel! Brug ikke aggressive rengøringsmidler! Smør låsen årligt! Kontroller skruesamlinger jævnligt!
- (SE)** Skötsel och underhåll: Förvara inga aggressiva kemikalier som klor eller vägsalt öppet! Ta bort solkräm och andra krämer med tvål och vatten. Använd inte slipande rengöringsmedel! Olja låset årligen! Kontrollera skruvanslutningarna regelbundet!
- (NO)** Stell og vedlikehold: ikke oppbevar aggressive stoffer, dvs. klor eller veisalt! Fjern solkrem eller andre kremer med vann og skyllemiddel! Ikke bruk slipende rengjøringsmidler! Smør låsen en gang i året! Kontroller skruerforbindelsene regelmessig!
- (PL)** Pielęgnacja i konserwacja: Nie przechowywać chemikaliów jak związki chloru lub sól drogowa. Ewentualne zabrudzenia usuwać mydłem i wodą. Nie używaj ściernych środków czyszczących! Co roku smaruj zamek! Regularnie kontroluj dokręcenie śrub!
- (SK)** Starostlivosť a údržba: Neskladujte agresívne látky, napr. chlór alebo posypovú soľ! Opalovací krém alebo iné krémy odstráňte vodou a leštidlom! Nepoužívajte abrazívne čistiace prostriedky! Raz ročne premažte zámky! Pravidelne kontrolujte skrutkové spoje!
- (SI)** Nega in vzdrževanje: Ne shranjujte agresivnih snovi, npr. Klor ali cestne soli! Losjon za sončenje ali druge kreme odstranite z vodo in sredstvom za izpiranje! Ne uporabljajte abrazivnih čistil! Ključavnico namažite enkrat letno! Redno preverjajte vijačne povezave!
- (CZ)** Péče a údržba: Neskladujte agresivní látky, např. chlor nebo posypovou sůl! Opalovací krém nebo jiné krémy odstraňte vodou a leštidlem! Nepoužívejte abrazivní čisticí prostředky! Jednou ročně promažte zámky! Pravidelně kontrolujte šroubové spoje!
- (HU)** Ápolás és karbantartás: Ne tároljon semmiféle agresszív vegyszert, mint pl.: klórt vagy sót bontatlan állapotban! Távolítsa el a naptejet és az egyéb krémeket víz és szappan használatával. Ne használjon súrolószereket! Évente olajozza be a zárat! Rendszeresen ellenőrizze a csavarokat!
- (HR)** Njega i održavanje: Ne skladištite agresivne tvari, tj. Klor ili cestovnu sol! Losion za sunčanje ili bilo koje druge kreme uklonite vodom i sredstvom za ispiranje! Ne koristite abrazivna sredstva za čišćenje! Podmažite bravu jednom godišnje! Redovito provjeravajte vijčane spojeve!
- (RO)** Ingrijire si intretinere: Nu depozitati substante agresive, de exemplu cloruri sau substante saline! Indepartati urmele de la cremele de protectie solara sau alte creme cu apa si sapun! Nu folositi substante de curatare abrazive! Aplicati ulei la incuietori o data pe an! Verificati piulitele regulat!



TEILEÜBERSICHT

Parts list · Liste des pièces · Stuklijst · Lista de piezas · Lista de parti · Deloversigt · Delöversikt · Del liste · Przegląd elementów · Zoznam dielov · Seznam delov · Seznam dílů · Tételtek áttekintése · Popis dijelova · Lista pieselor



1 DECKEL - PAKET

Lid package · Colis du couvercle · Dekselpakket · Paquete de tapa · Pacchetto di coperchio · Dækselpakke · Lockpaket · Lokk pakke · Opakowanie zawierające pokrywę · Balenie s vekom · Paket pokrovov · Balení s víkem · Tetőcsomag · Paket poklopca · Pachet cu capac

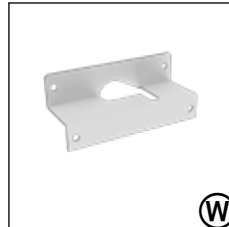
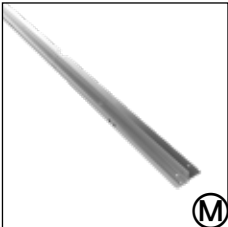
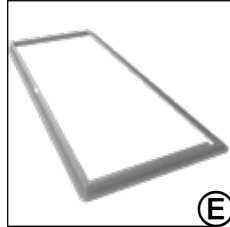

KLEINTEILEPAKET

small parts package | carton de petites pièces

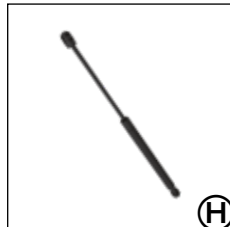

2 KORPUS - PAKET

Corpus package · Colis de l'ossature · Framepakket · Corpus · Corpus · Kassepakke · Stompaket · Corpus-pakke · Opakowanie zawierające elementy ścienne · Korpus-balenie · Korpusni paket · Korpus - balení · Korpuszcsomag · Korpusni paket · Pachet panou

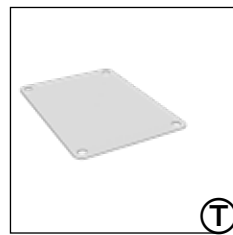
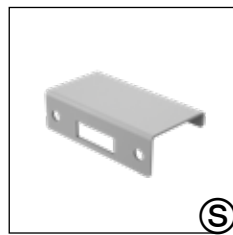
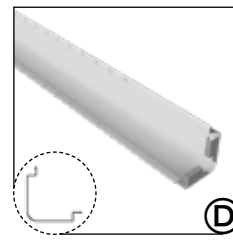
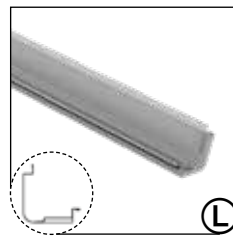
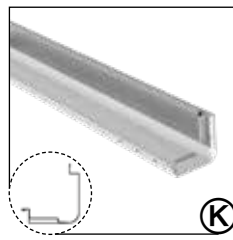
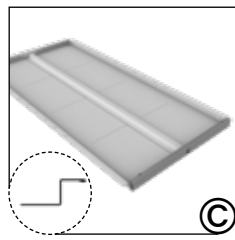
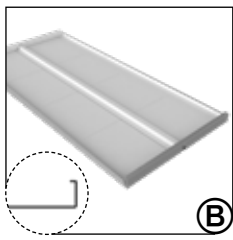

KLEINTEILEPAKET

small parts package | carton de petites pièces







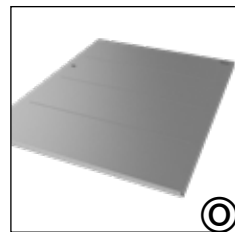

3 TÜR - PAKET

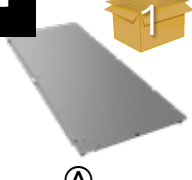
Doorpackage · Carton de portes · Deurpakket · Kit de puerta · Pacco porta · Dørpakke · Dörrpaket · Dørpakke · opakowanie zawierające drzwi · Balenie dverí · Paket vrat · Balení dveří · Ajtó csomag · Paket vrata · Pachet usa





1.

 A	1x	 a D2	1x	 D2	2x
M6 x 12  D2	4x	 b D2	2x	 D2	2x
M4 x 18  D1	2x				

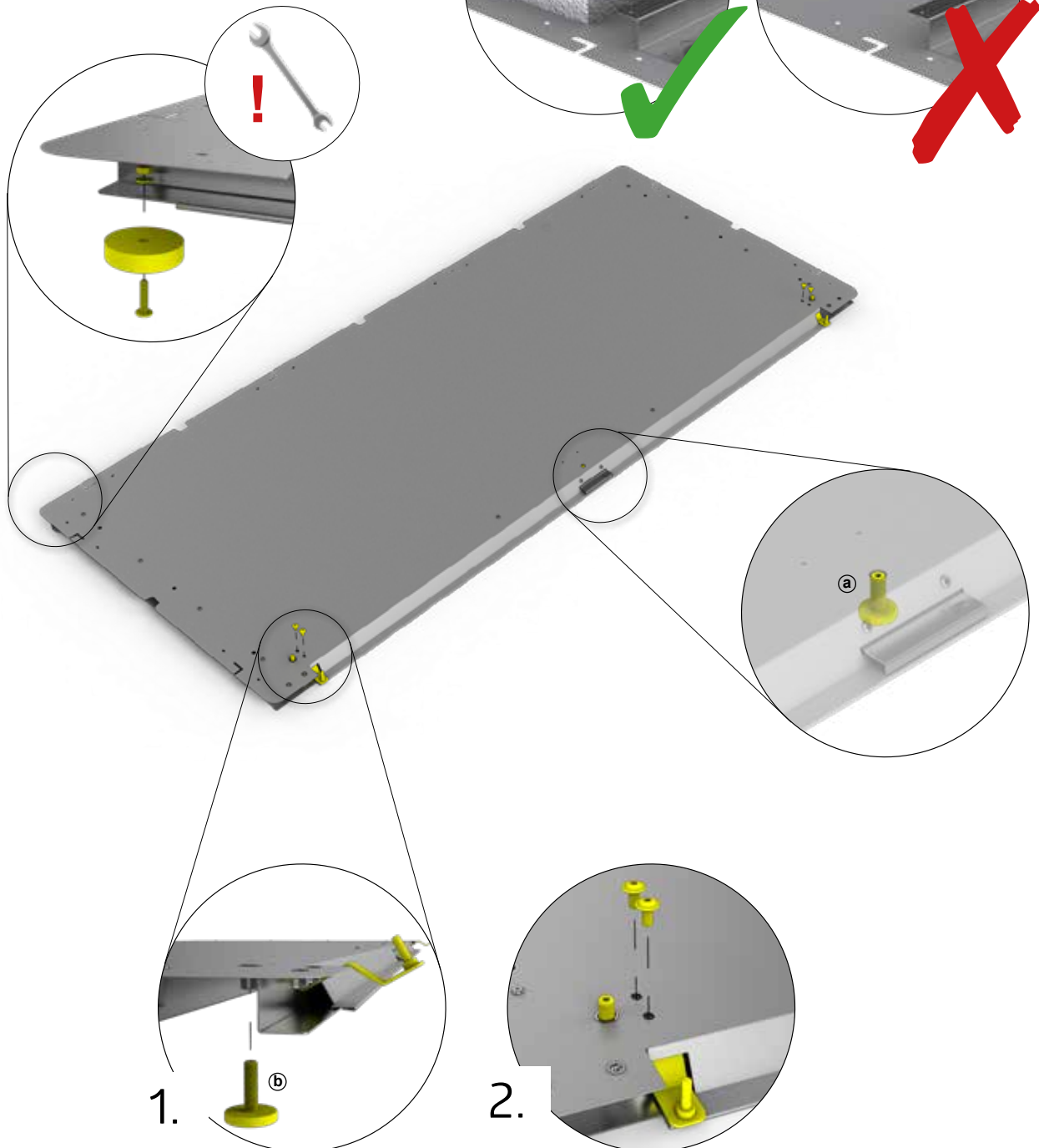
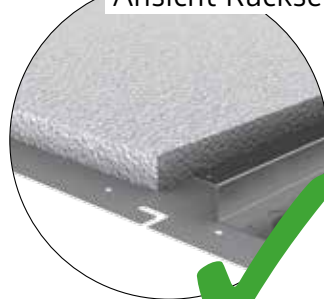
Ansicht Rückseite - Back side view



2.

 Ⓛ	1x	 4,2 x 13 Ⓛ1	1x	 M6 x 12 Ⓛ2	2x
---	----	---	----	--	----

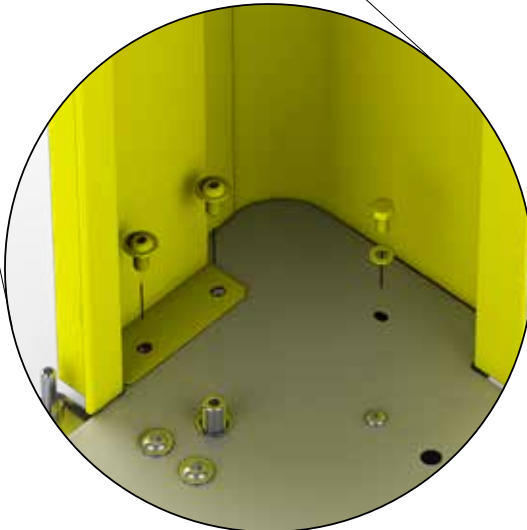
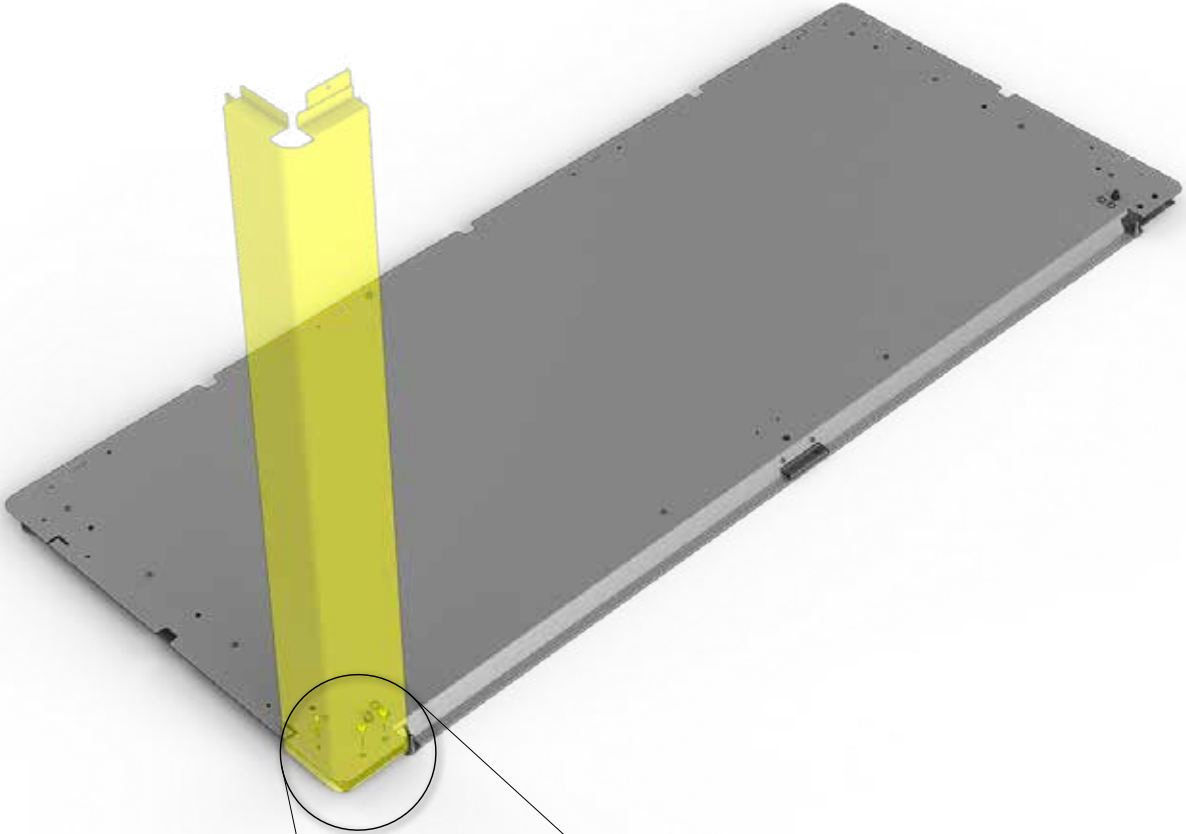

3.

 <p>Ⓑ</p>	1x	 <p>4,2 x 13 Ⓓ1</p>	2x	 <p>M4 x 10 Ⓓ1</p>	4x
--	----	---	----	--	----

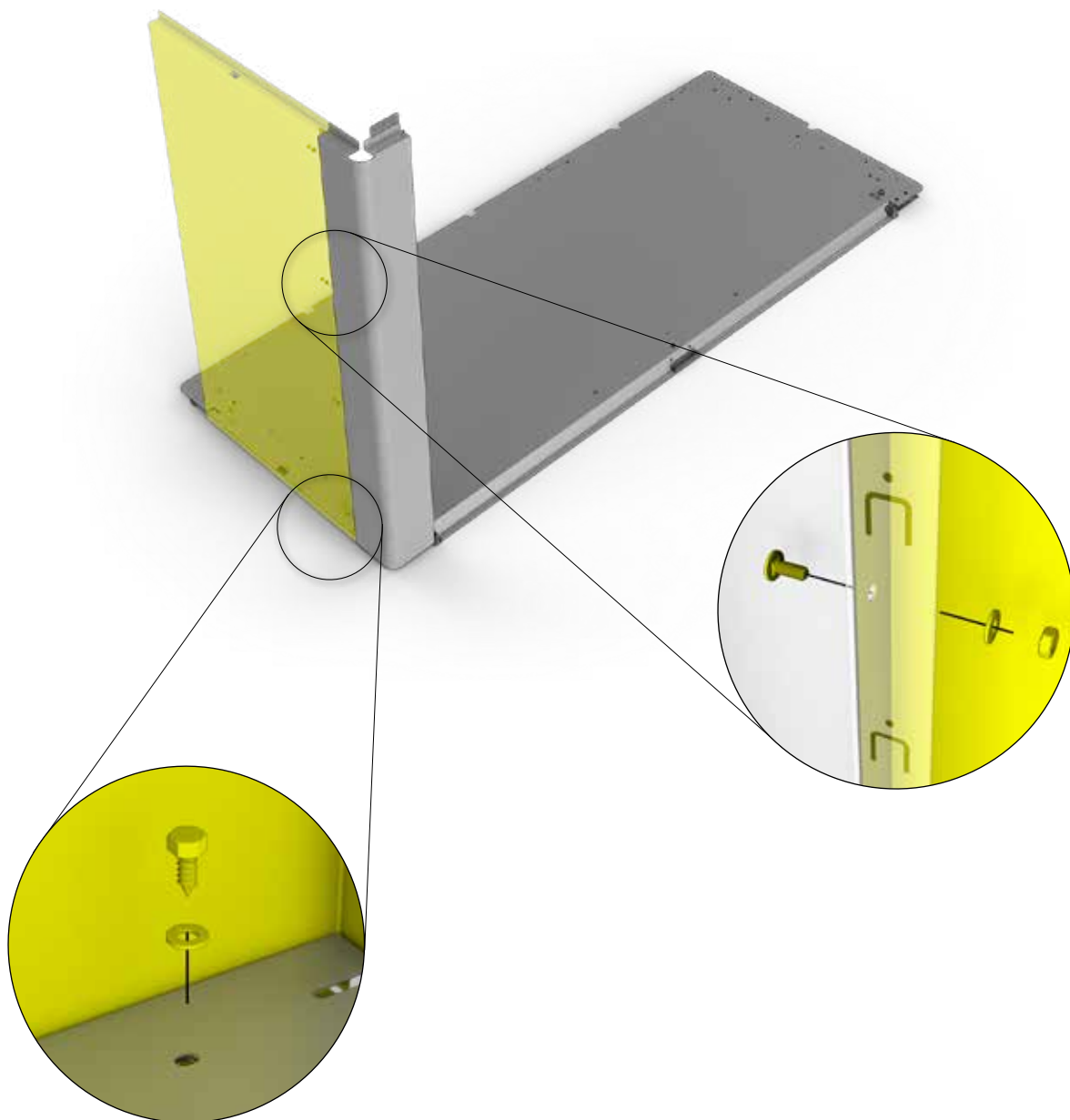

4.

 Ⓣ	 2	1x	4,2 x 13  Ⓣ1	 1	2x	M4 x 10  Ⓣ1	 1	4x
--	--	----	---	--	----	--	--	----

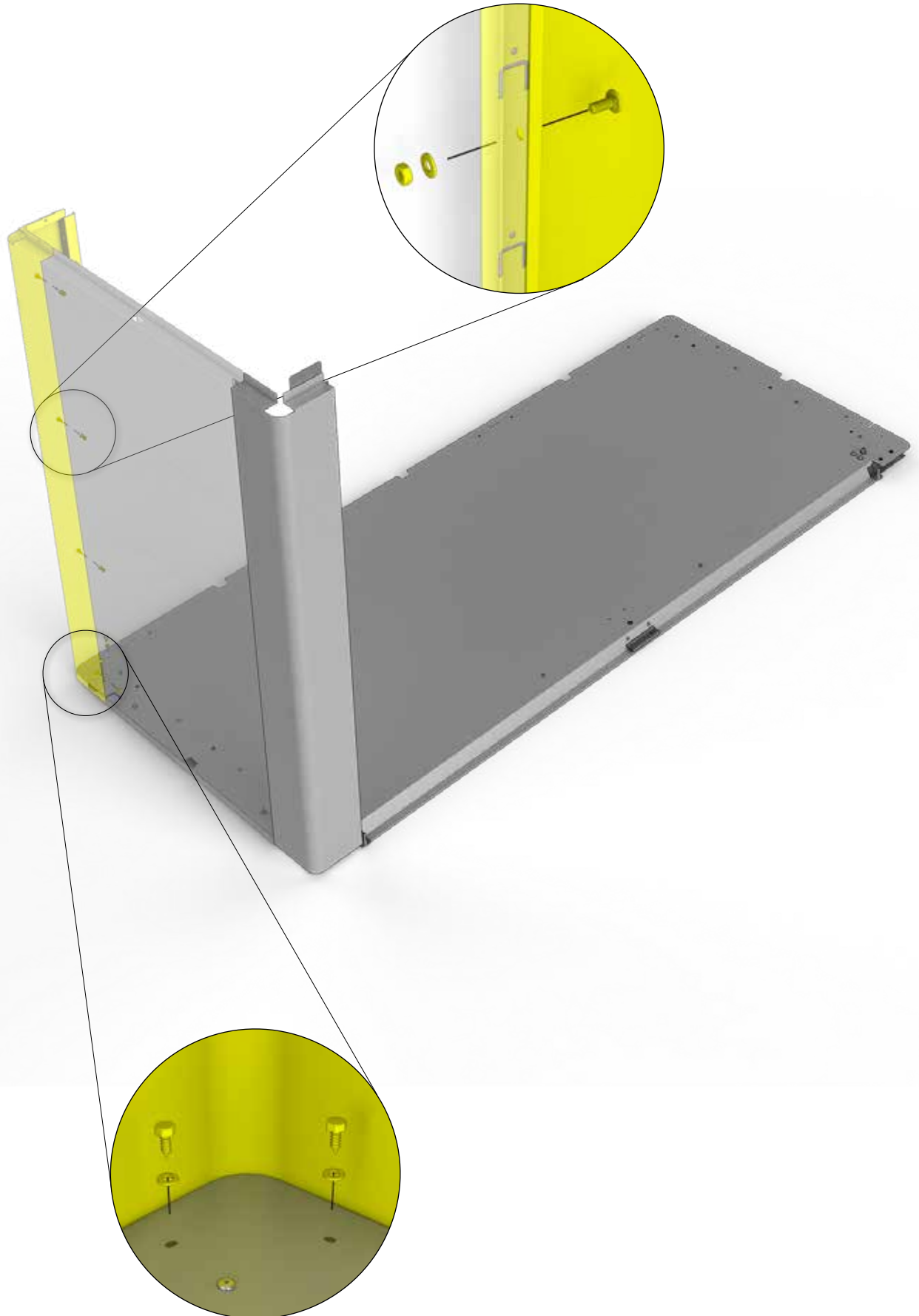

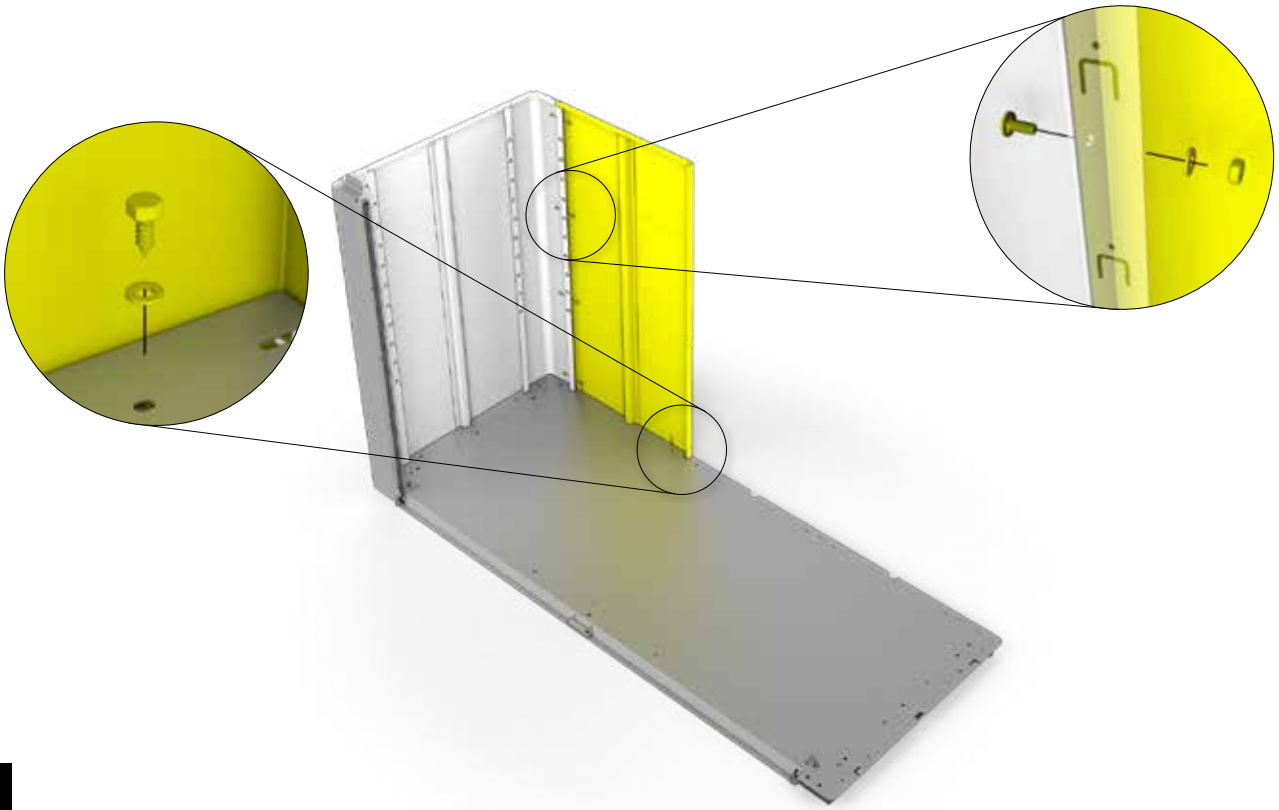

5.

 ⓑ	1x	 4,2 x 13 ⓓ1	2x	 M4 x 10 ⓓ1	4x
--	----	--	----	---	----

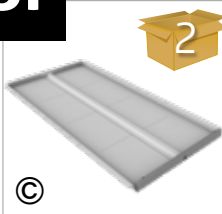

6.

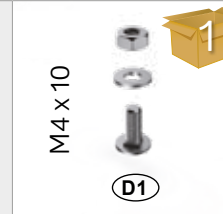
 ⓒ	1x	 4,2 x 13 ⓓ1	2x	 M4 x 10 ⓓ1	4x
---	----	---	----	--	----

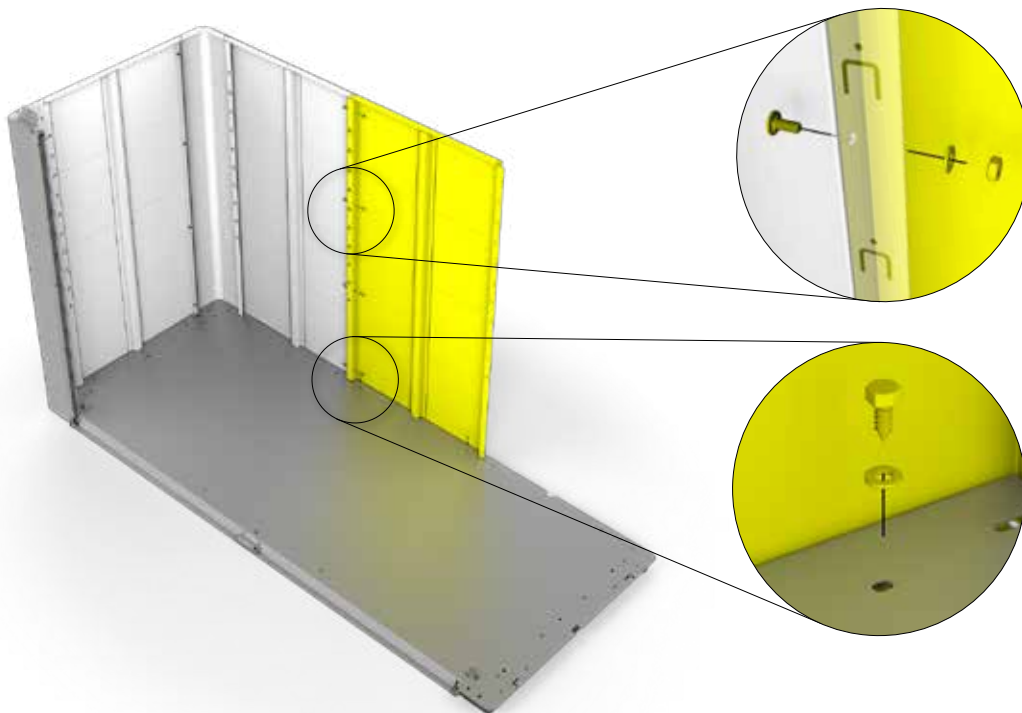

7.

 Ⓚ	1x	 4,2 x 13 ⓀD1	1x	 M6 x 12 ⓀD2	2x
--	----	---	----	--	----

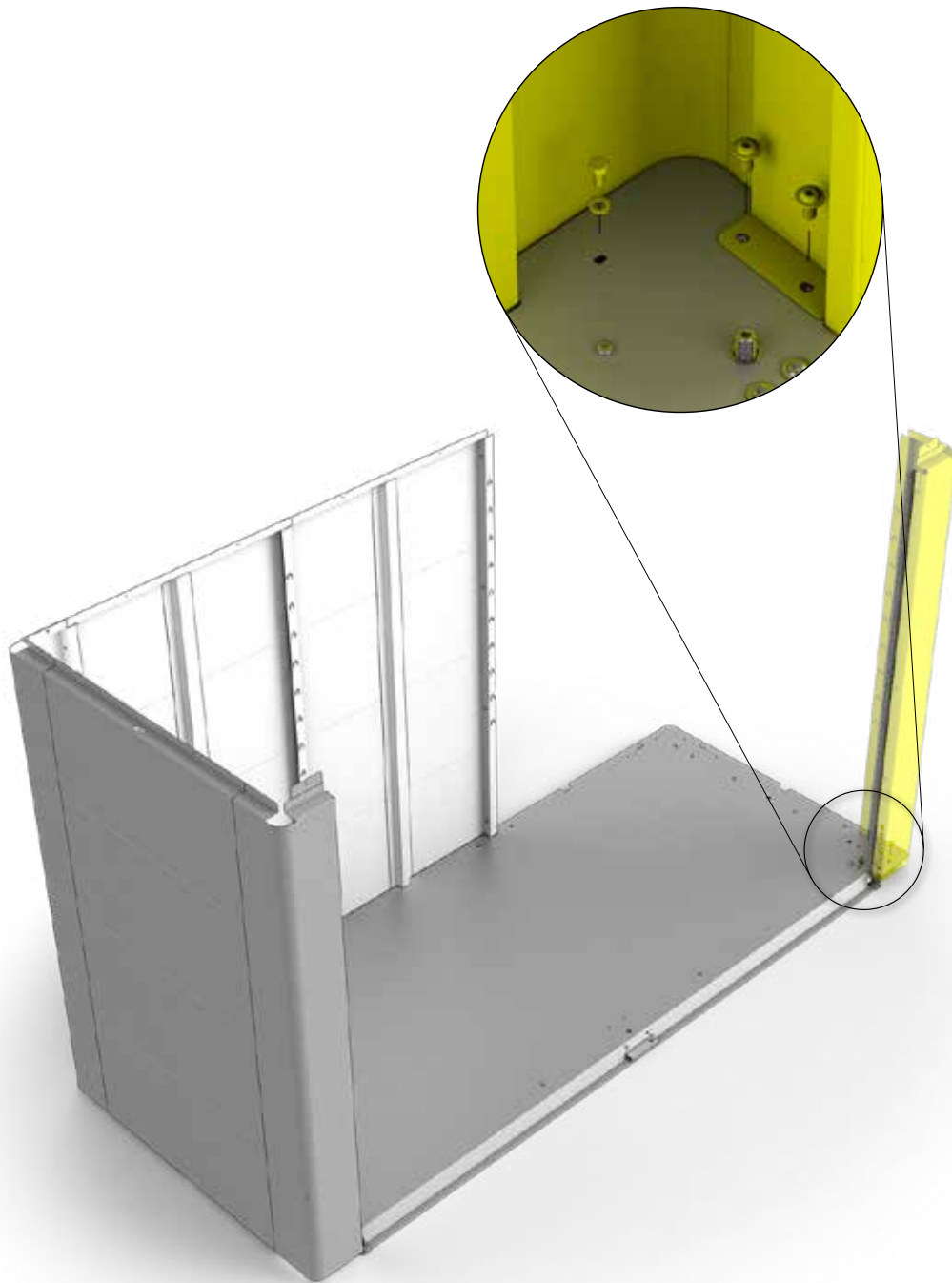





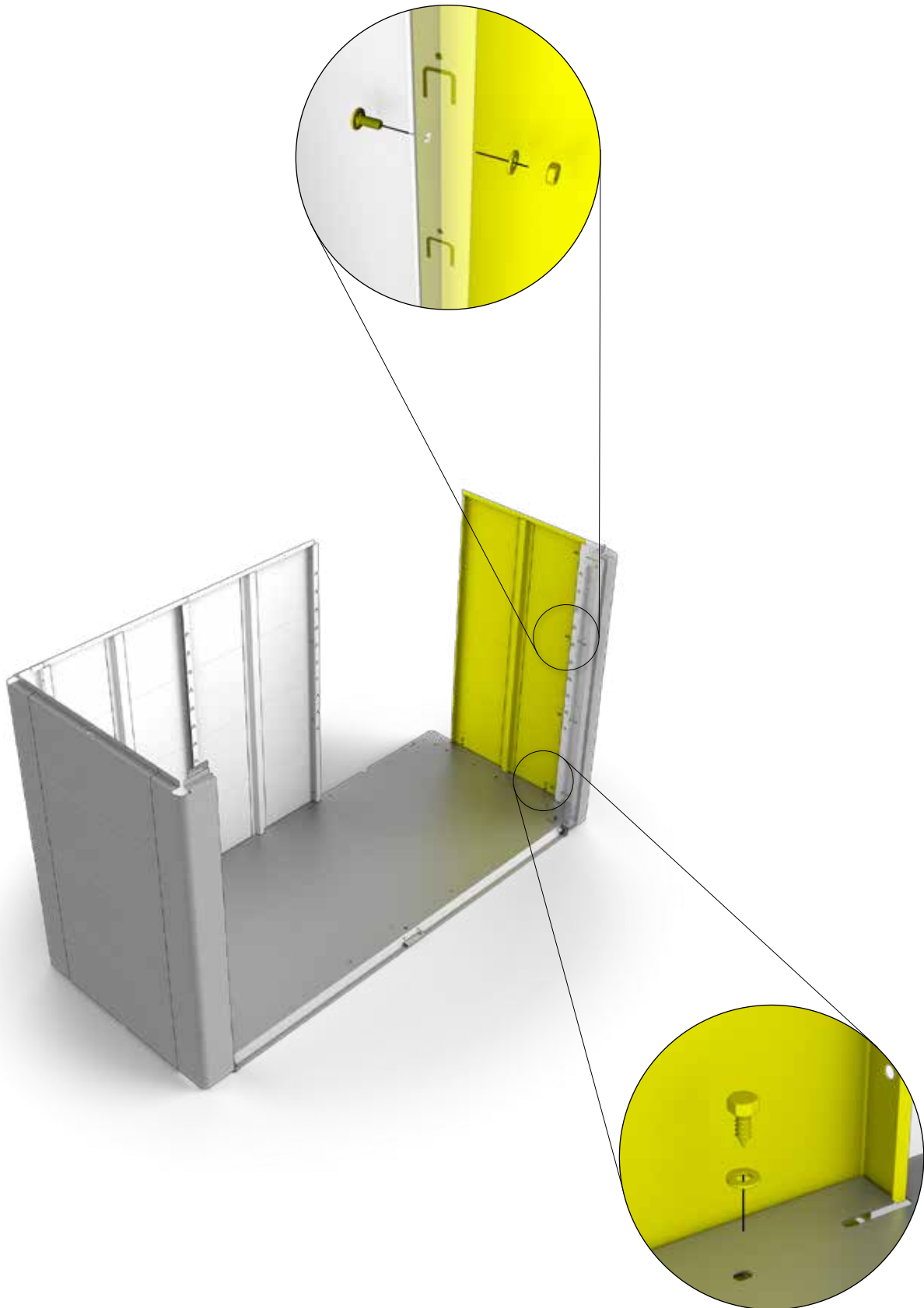

8.

	1x		2x		4x
---	----	--	----	--	----



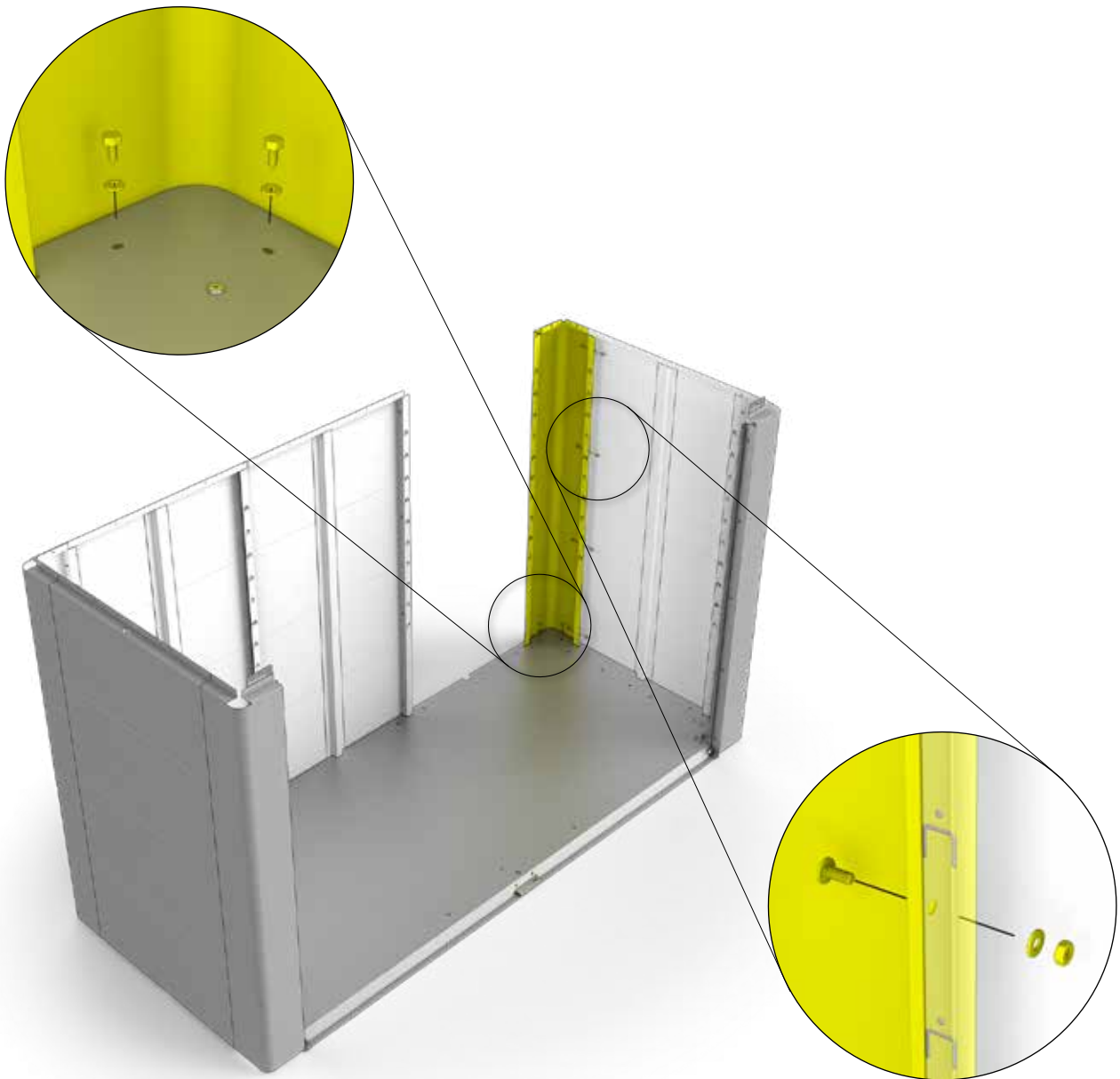

9.

 Ⓓ	 2	1x	4,2 x 13  Ⓓ1	 1	2x	M4 x 10  Ⓓ1	 1	4x
--	--	----	---	--	----	--	--	----

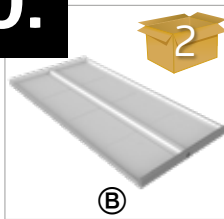

10.

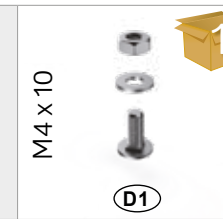
	1x		2x		8x
---	----	--	----	--	----

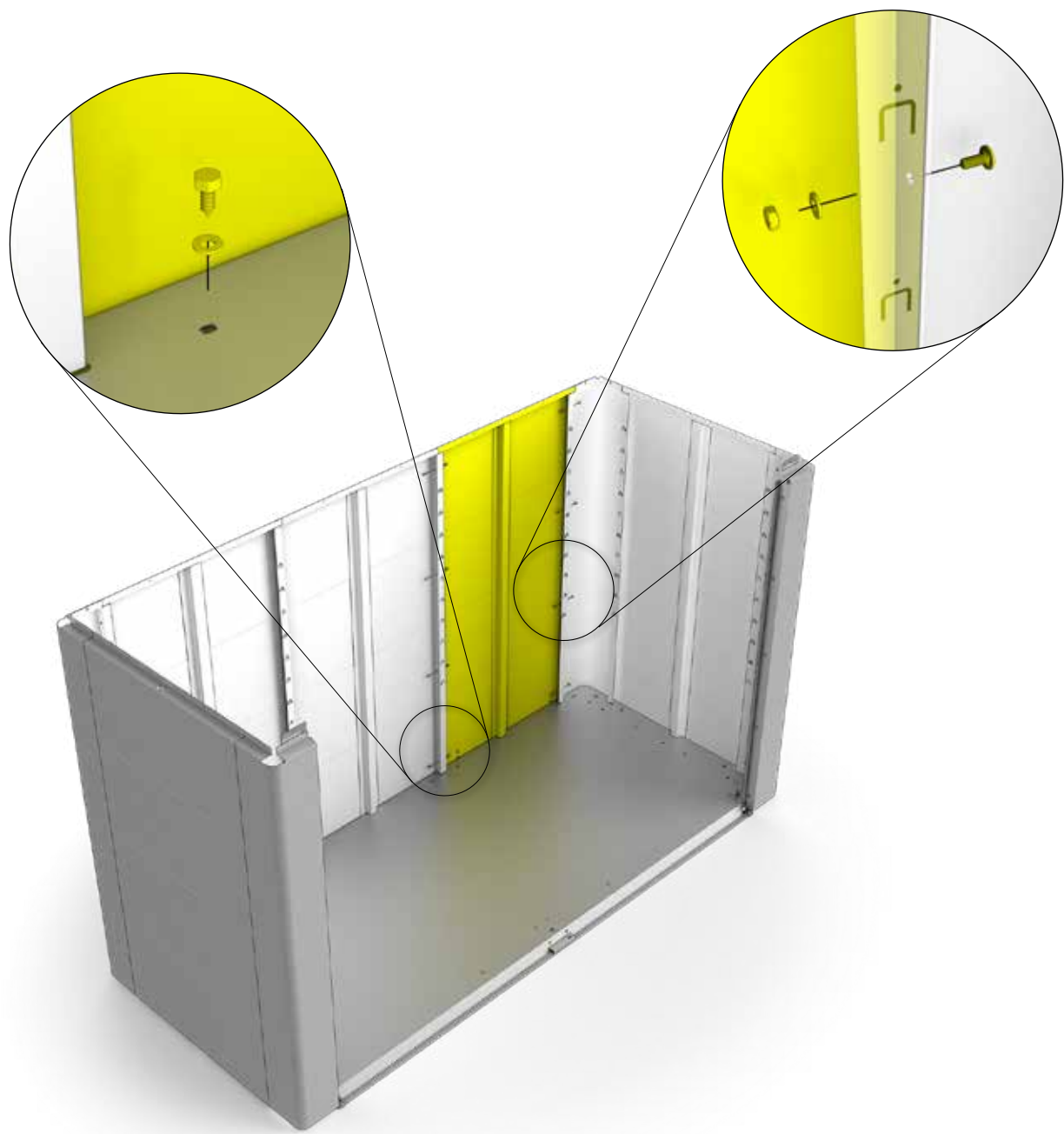

11.

	1x	M4 x 10 	2x		2x
---	----	---	----	--	----

1.

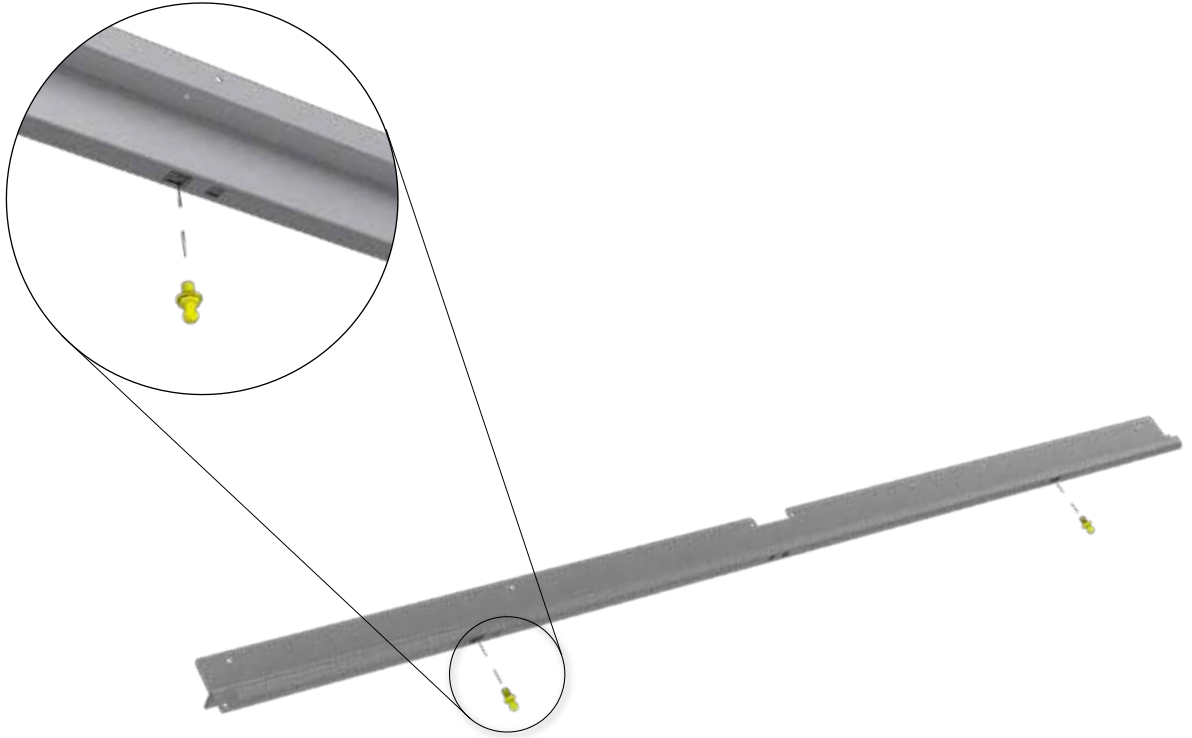

2.

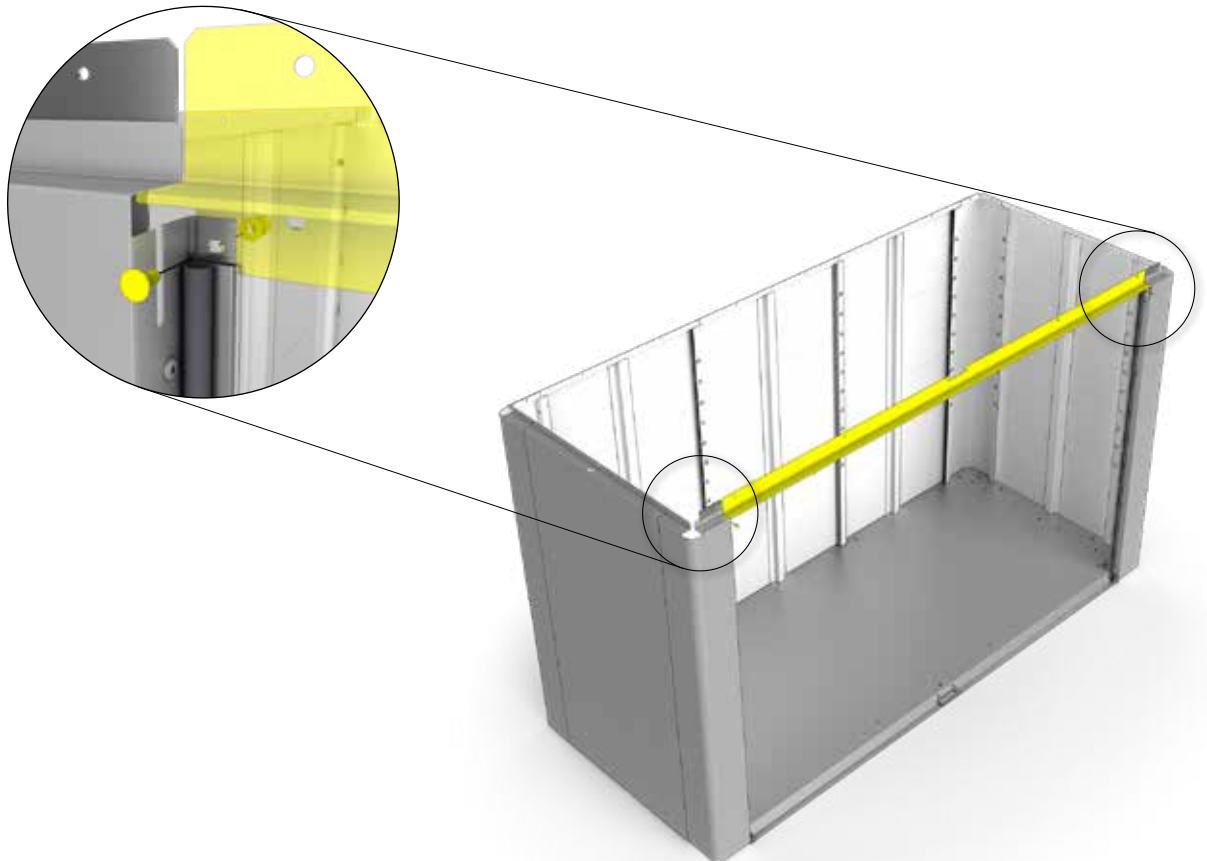

12.

2





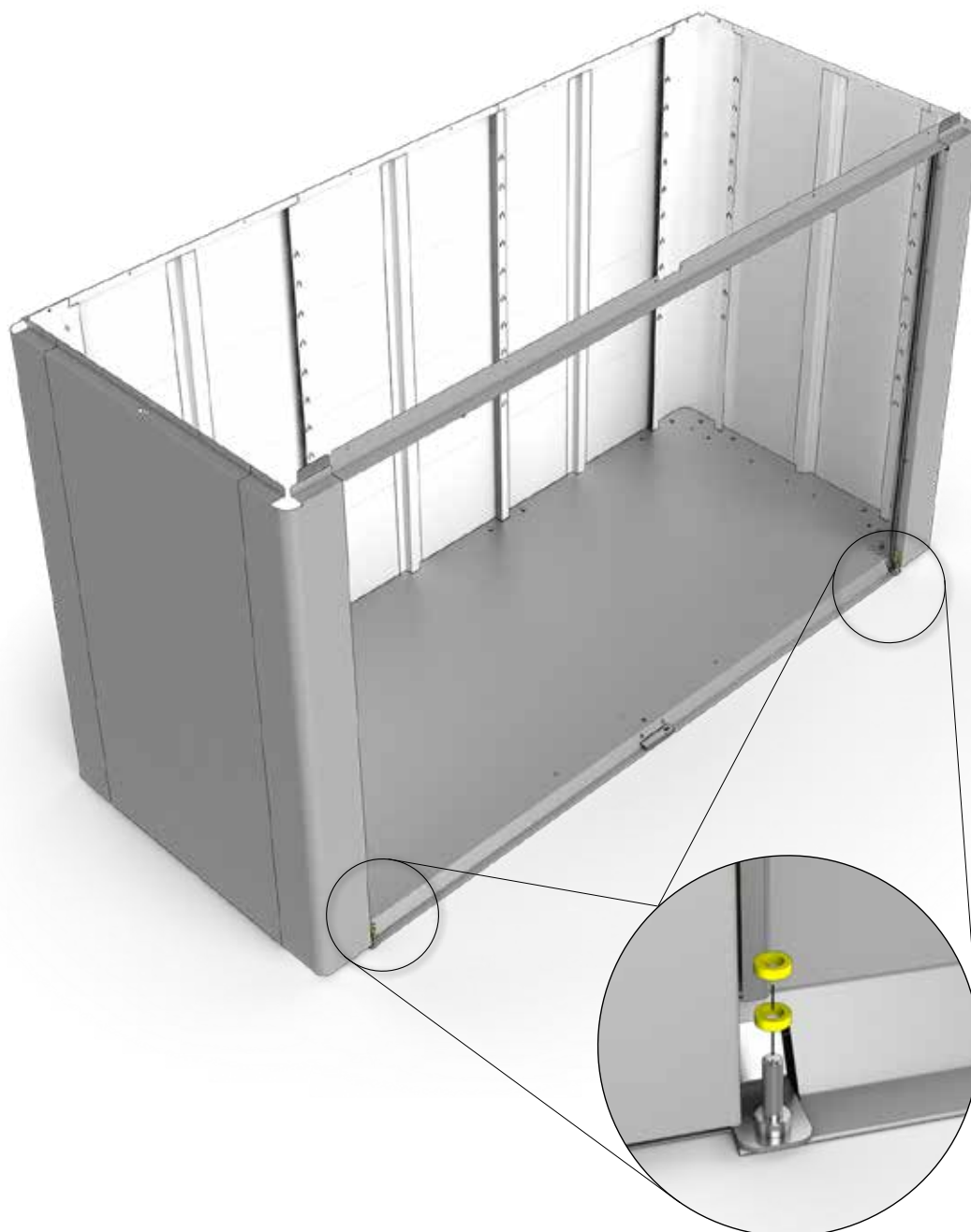

D2

4x





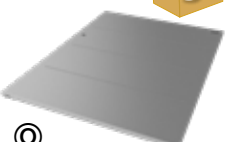

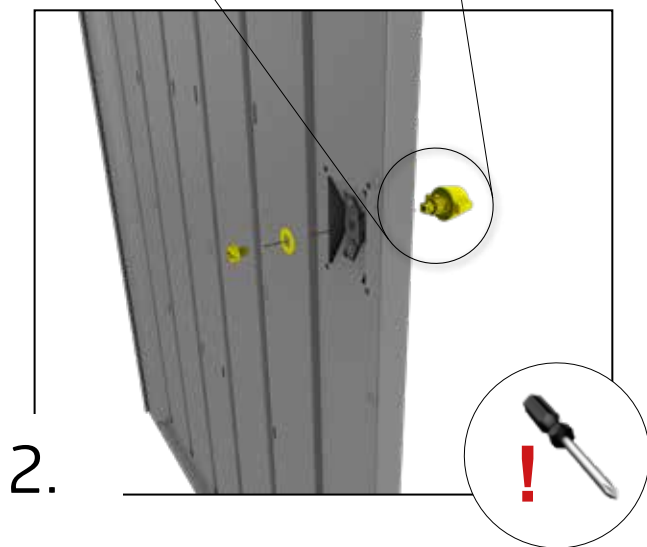
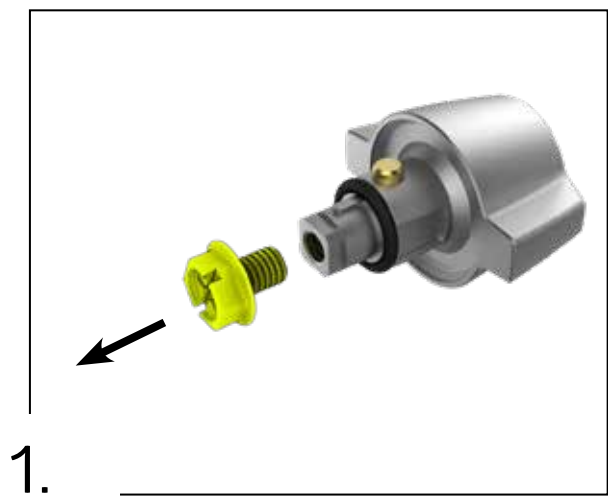
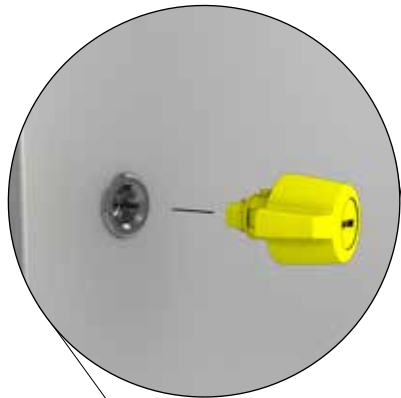

13.

 <p>Ⓣ</p>	<p>1x</p>	<p>3,9 x 13</p>  <p>Ⓣ</p>	<p>4x</p>	 <p>ⓧ</p>	<p>1x</p>
 <p>Ⓣ</p>	<p>1x</p>	 <p>Ⓢ</p>			



14.

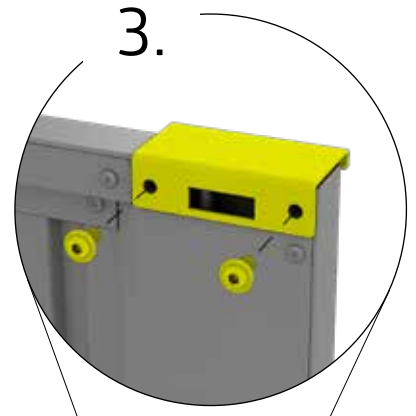
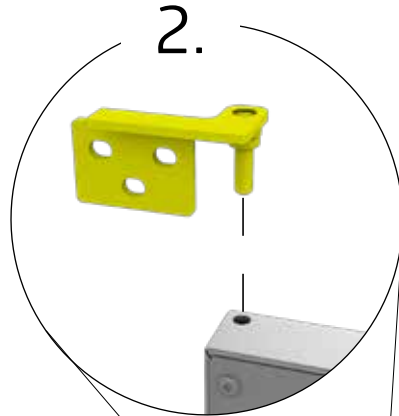
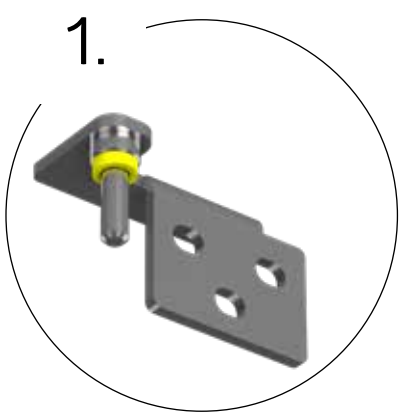

 (D2)	2x	 (D2)	1x	 (D2)	1x
 (N)	1x	 (S)	2x	 (D2)	2x
M6 x 12  (D2)	8x				

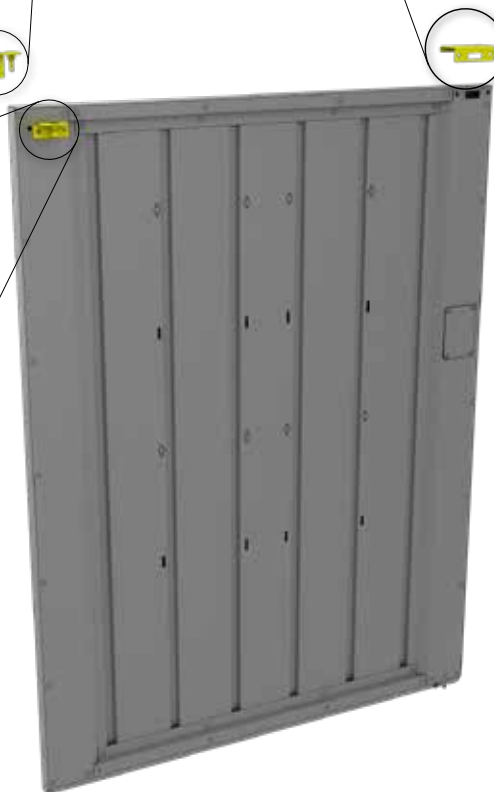
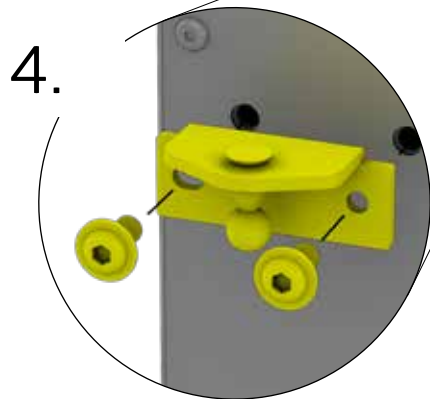

2x



15.

M6 x 12  D2		6x
--	---	----

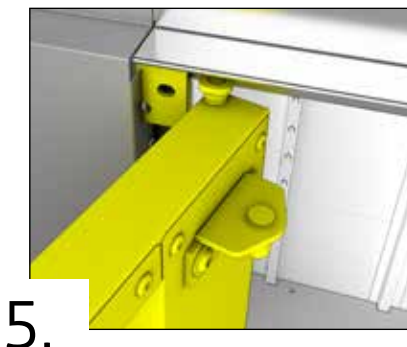
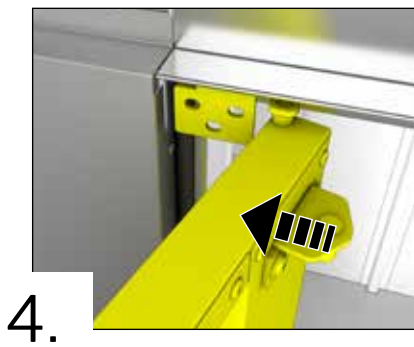
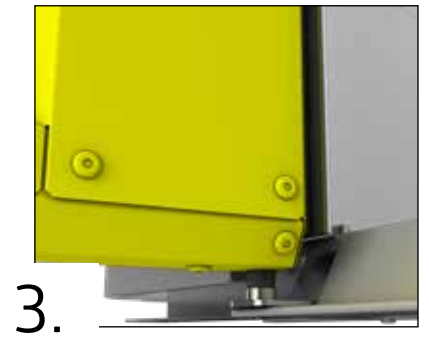
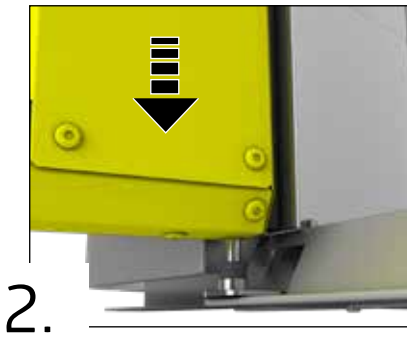
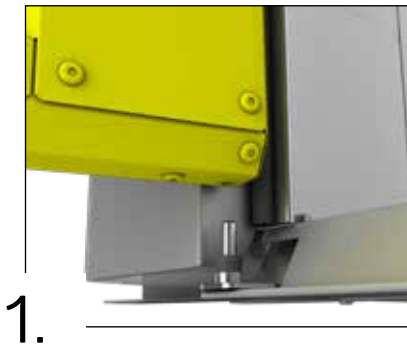

16.

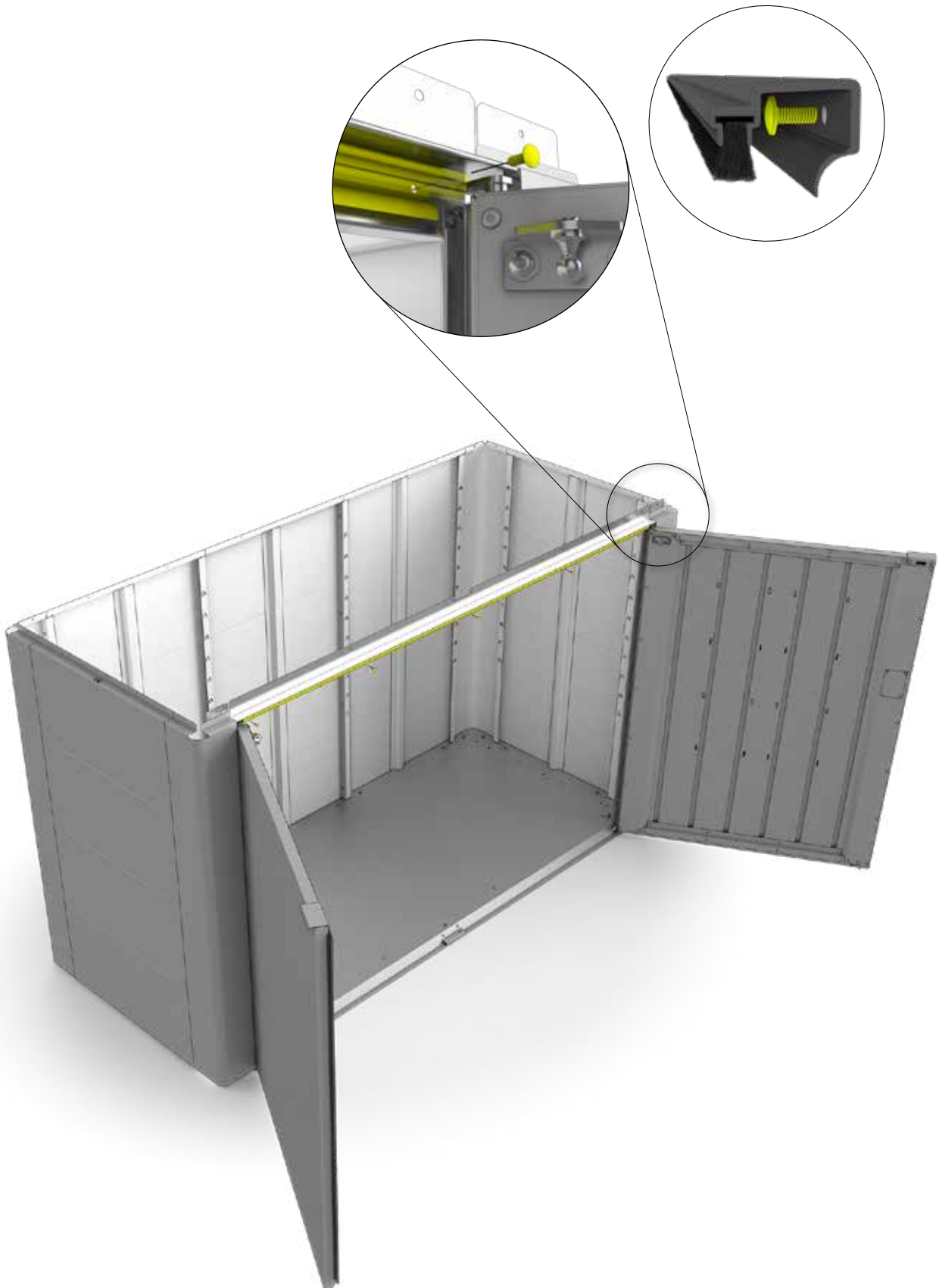

	1x	M4 x 10		5x
---	----	---------	---	----

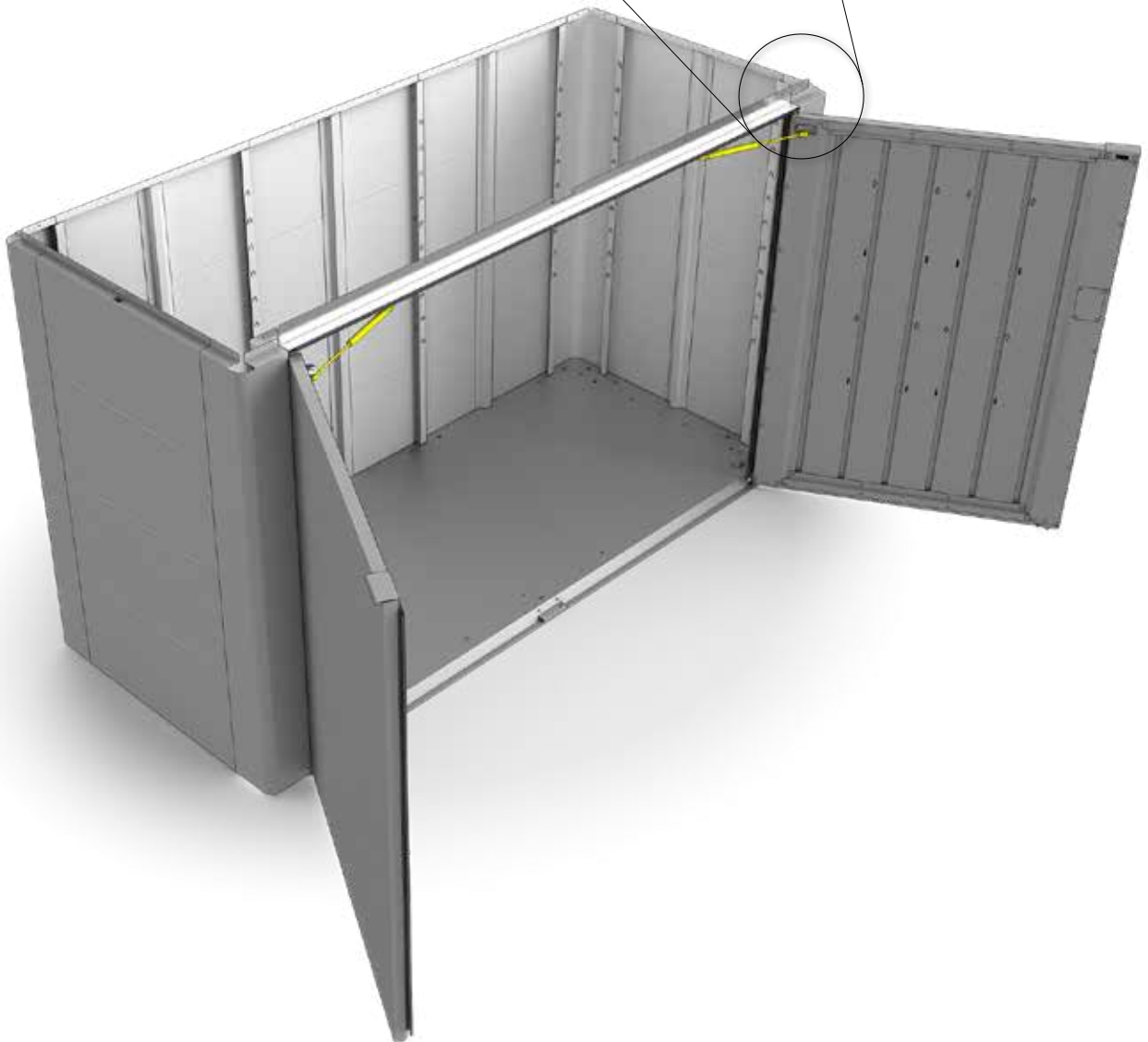
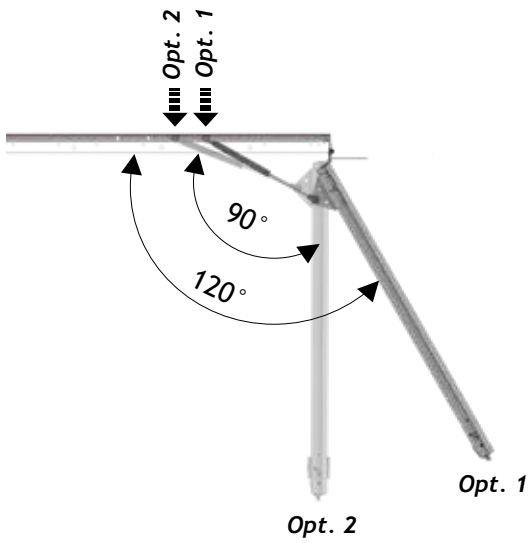
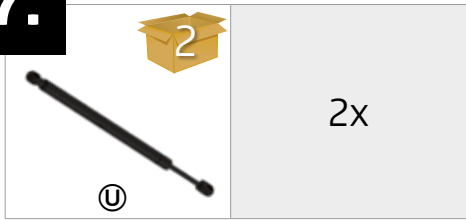

17.



18.

 D2	1x	M6 x 12	 D2	2x
---	----	---------	---	----

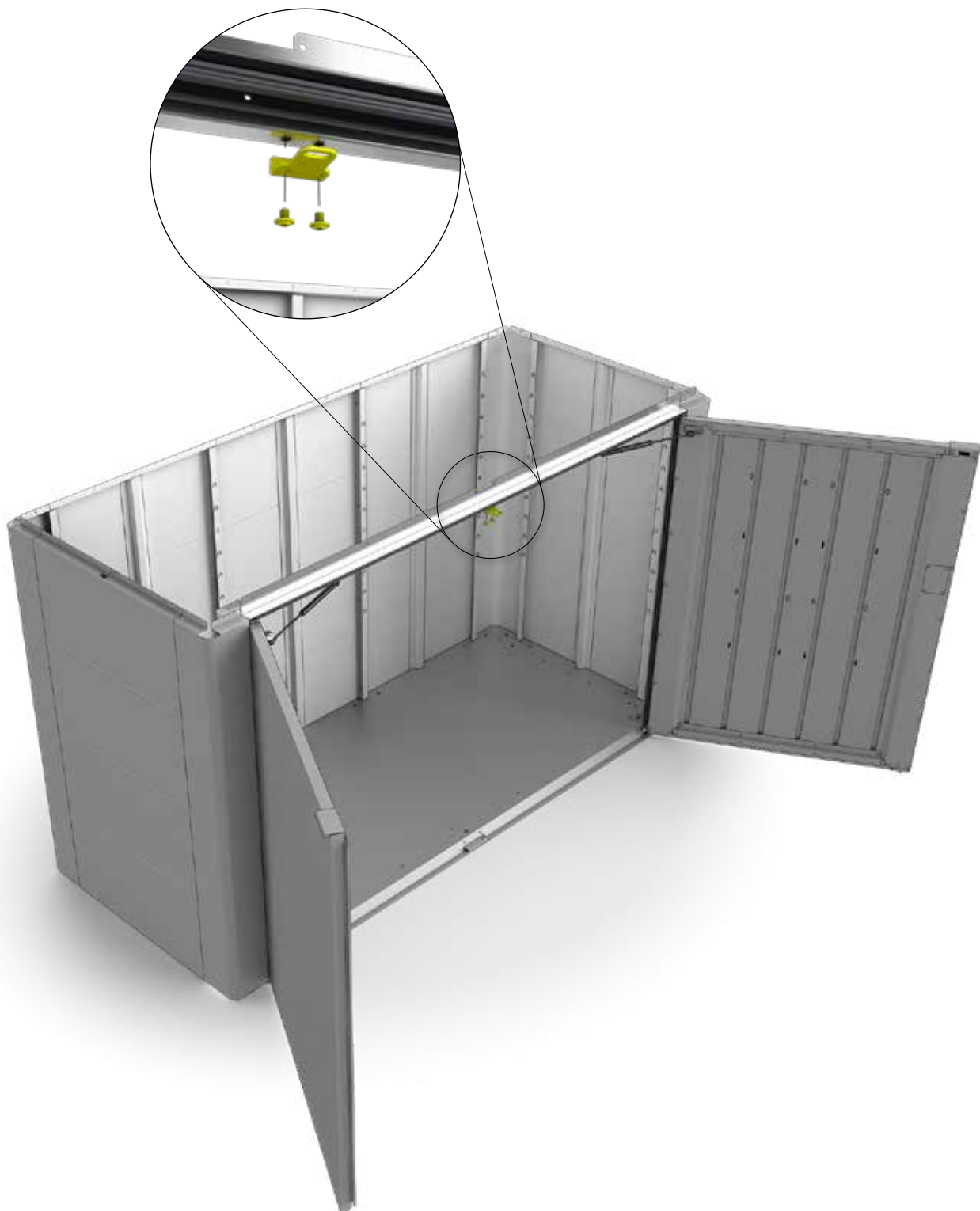

19.

 E	1x	M4 x 10  D1	16x	 G	1x
--	----	---	-----	---	----

X

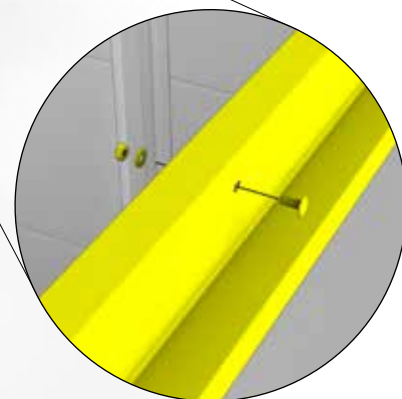
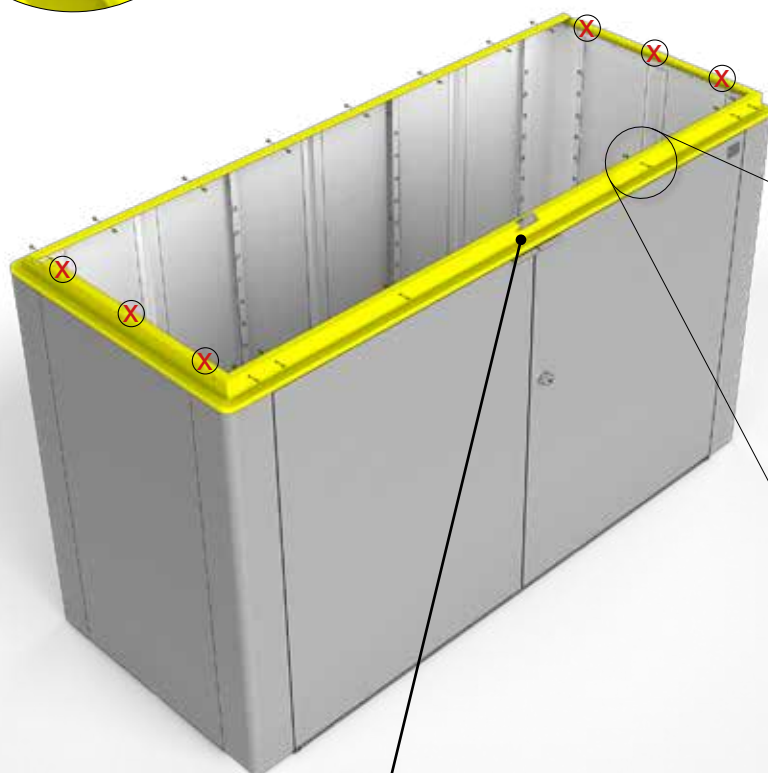
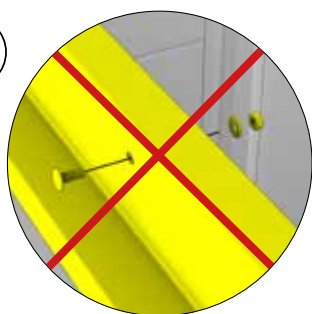

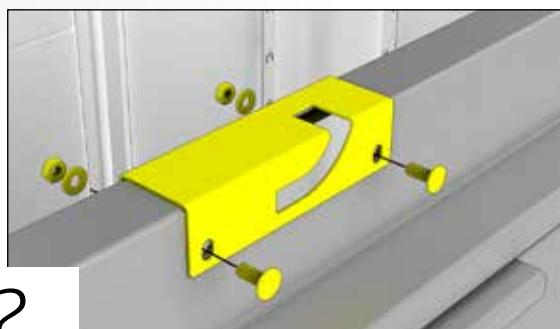

1.



2.

20.

 Ⓚ	1x	 Ⓡ	1x	M4 x 10  ⓓ1	4x
 ⓓ1	5x				

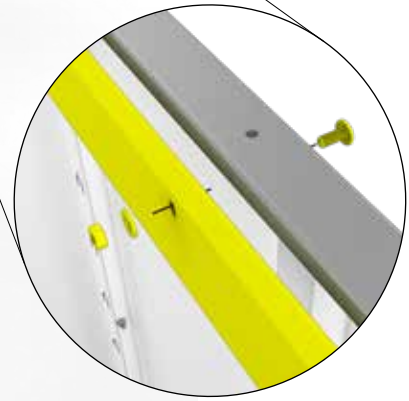
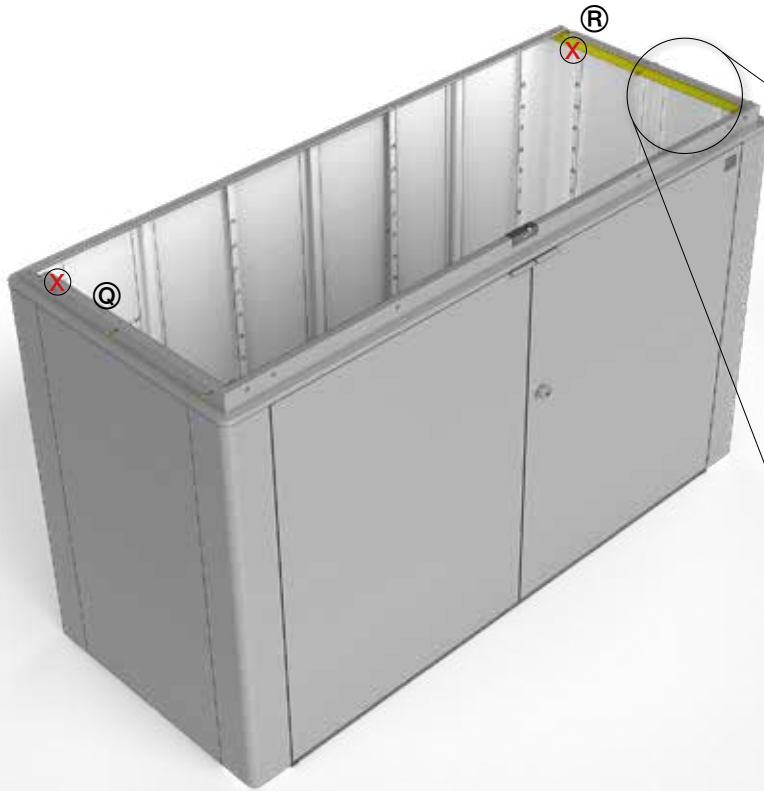
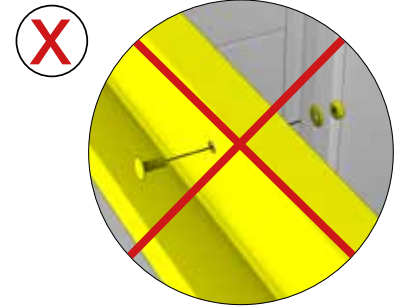





ZIEHEN SIE JETZT ALLE SCHRAUBVERBINDUNGEN FEST AN!

Tighten now all nuts and connections securely! - Serrez maintenant les vis à fond! - Draai nu alle schroeven vast! - Ahora puede apretar y fijar todos los tornillos y tuercas - Adesso serrare a fondo tutti i dadi - Fastspænd nu alle bolt-/skruerforbindelser! Dra nu át alla skruvförband ordentligt! - Stram nå alle muttere og tilkoblinger! - Teraz dokręć wszystkie śruby - Teraz utiahnite všetky spoje! - Zdaj varno privijte vse matice in povezave! - Nyní utáhněte všechny spoje! - Most húzza meg jól az összes csavart! - Sada čvrsto zategnite sve matice i spojeve! - Strangeti acum suruburile si elementele de conectare!

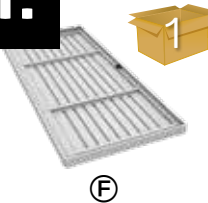

21.

 ⓕ	1x	 3,9 x 13 ⓓ2	4x	 ⓓ	1x
 ⓓ1	1x	 ⓧ	1x		

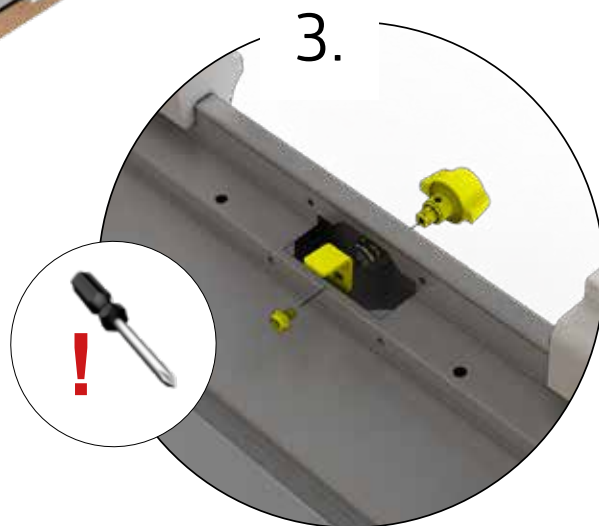
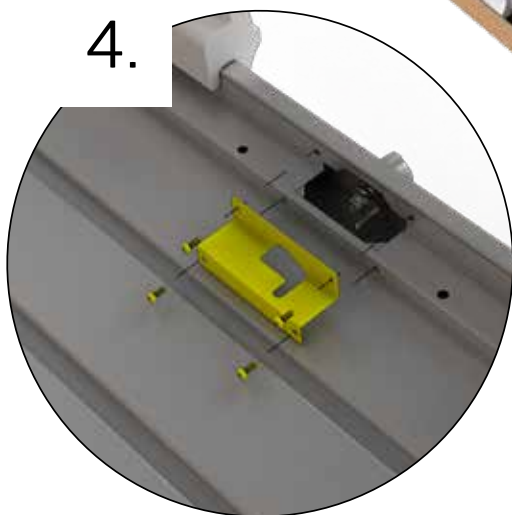
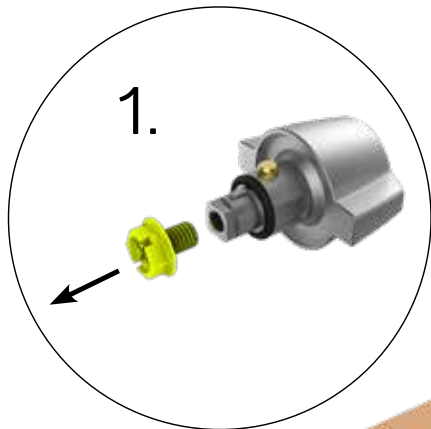

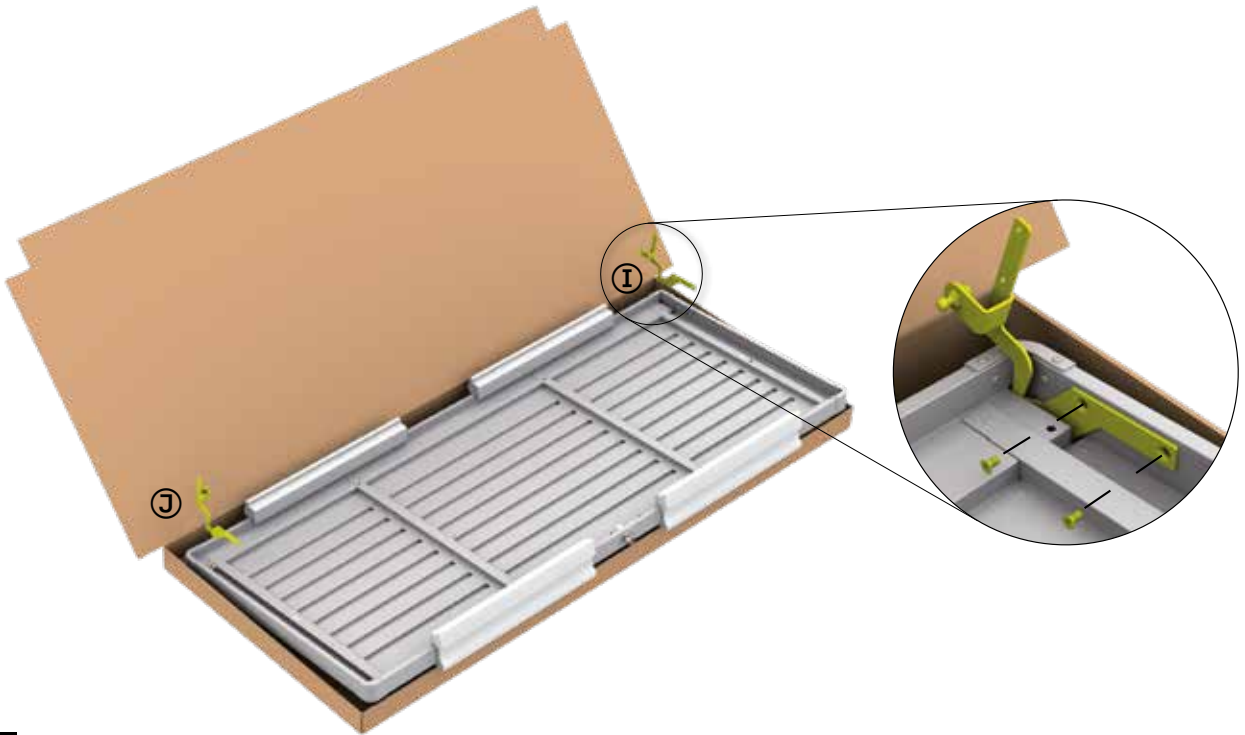

22.

 ①	1x	 ②	1x	M6 x 16  ①	4x
--	----	--	----	---	----



23.

 ①	10x	 ①	2x
--	-----	--	----

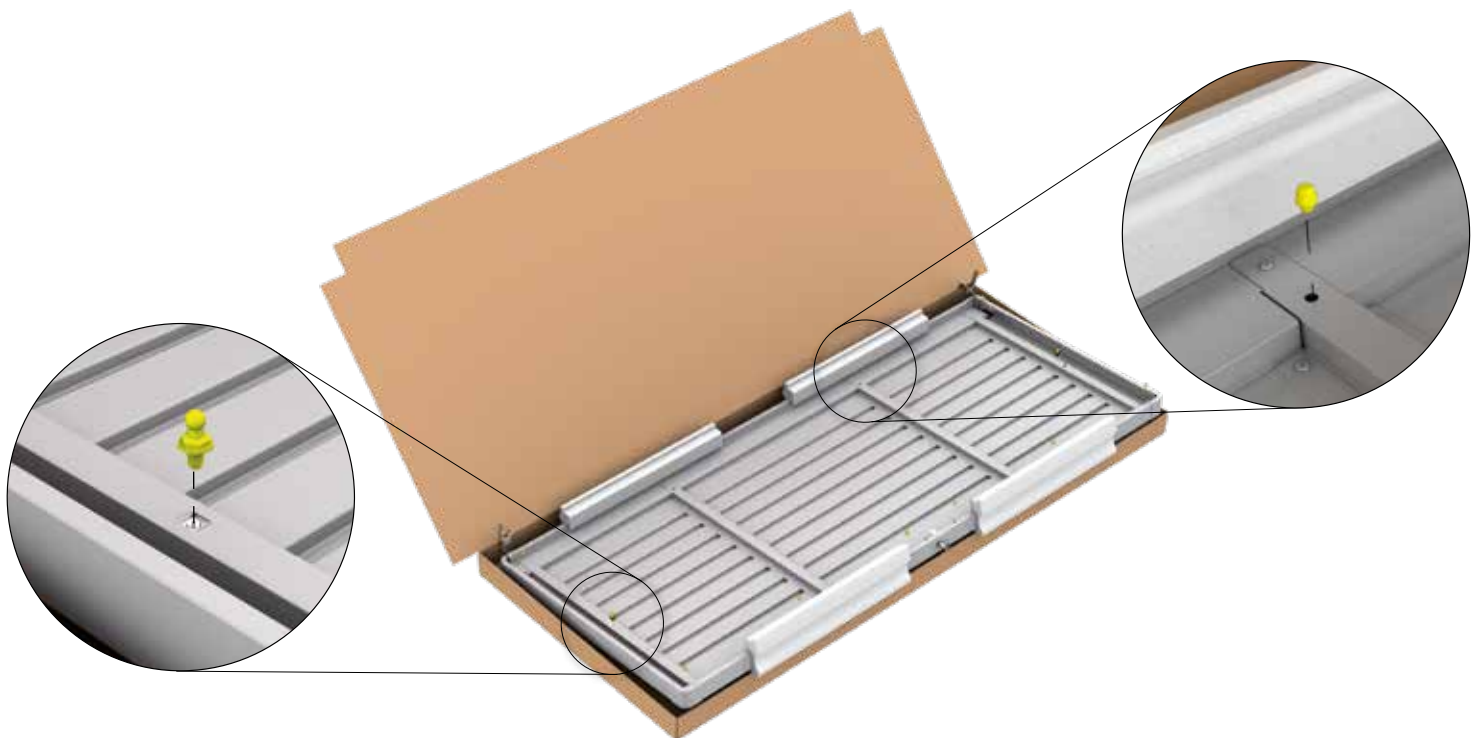

24.

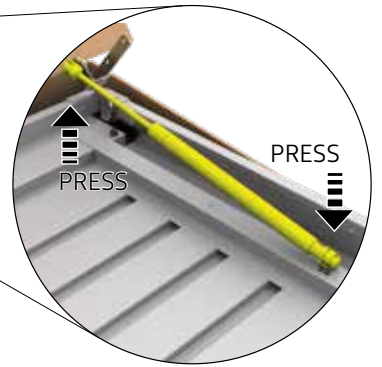

25.

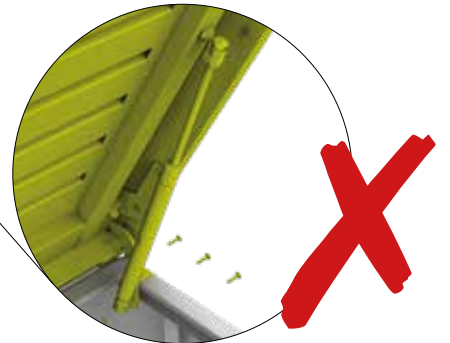
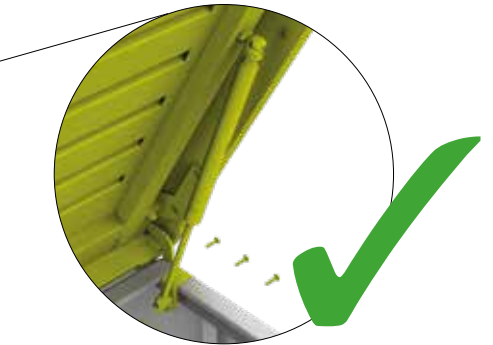
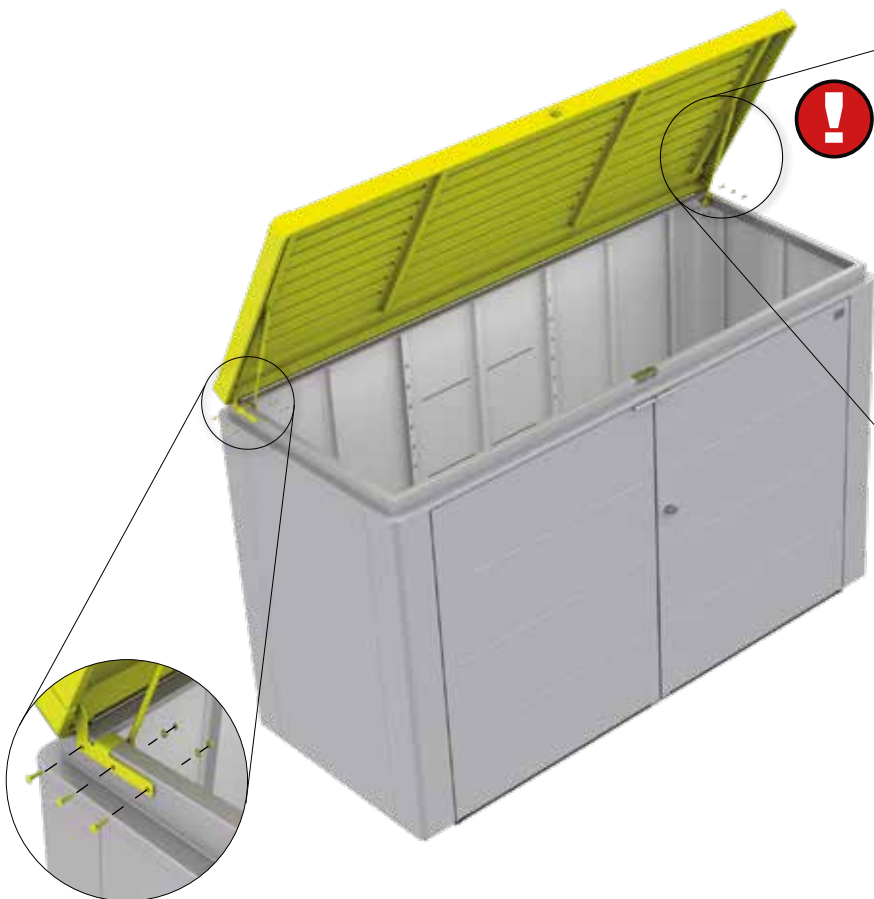
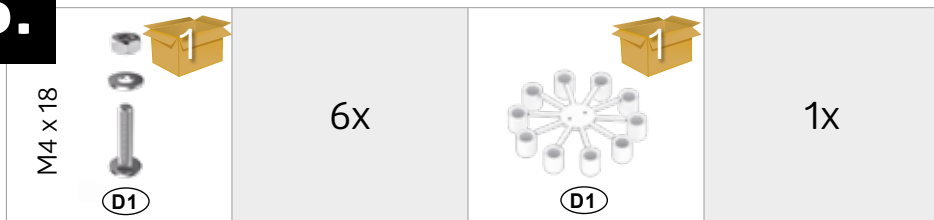

26.



D1

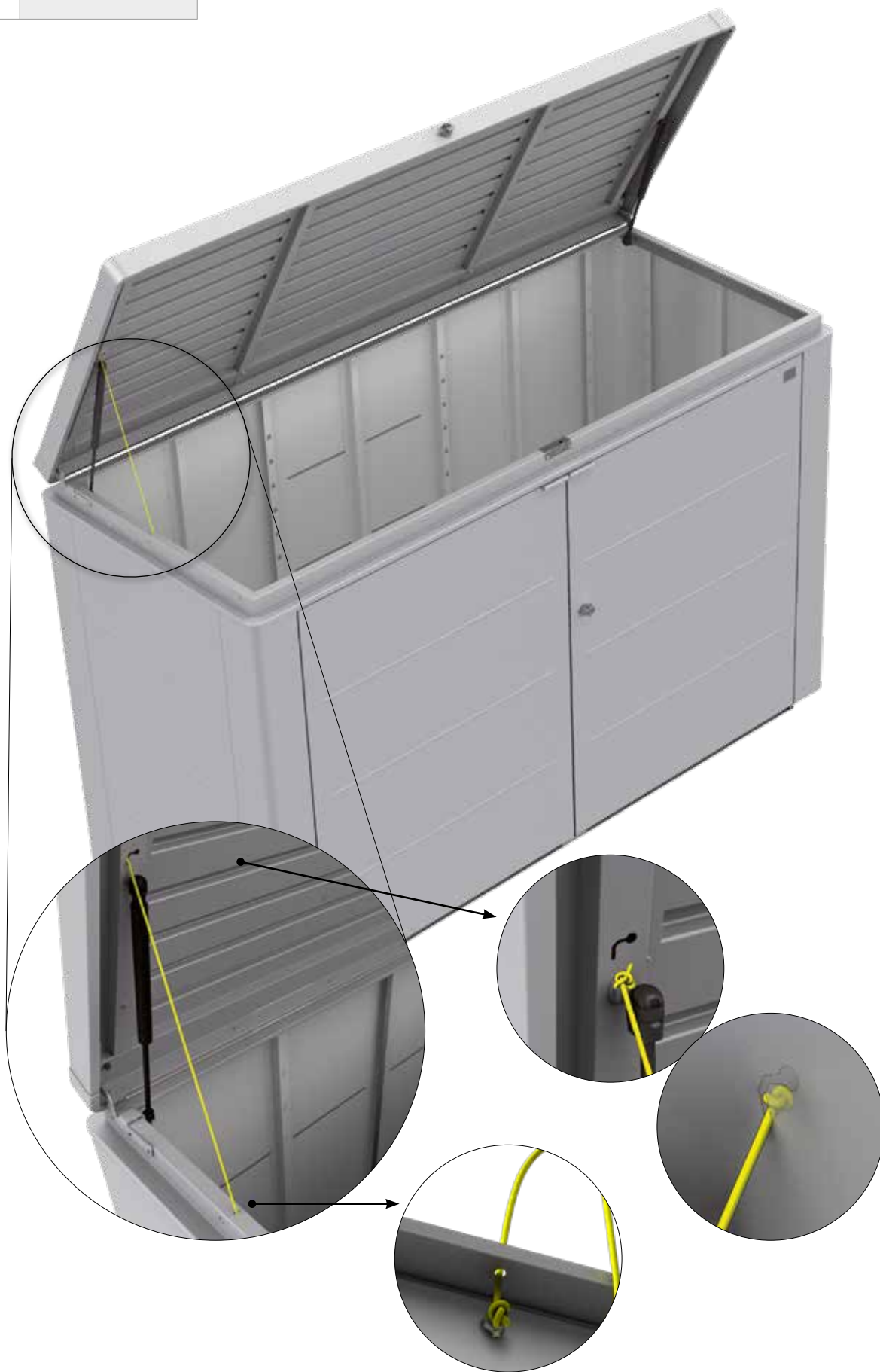

1x

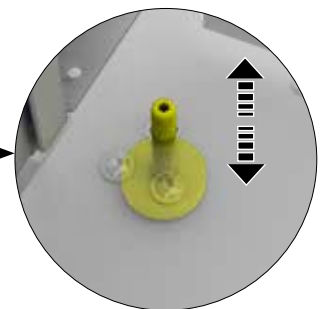
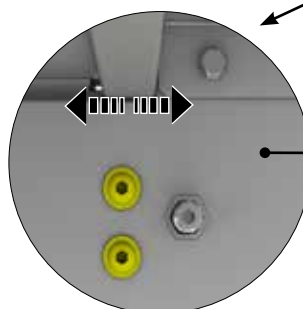
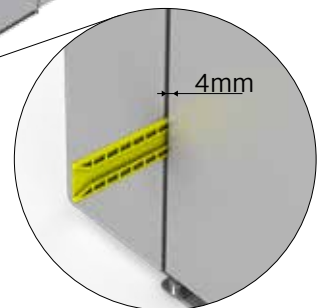
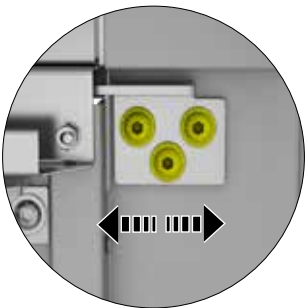
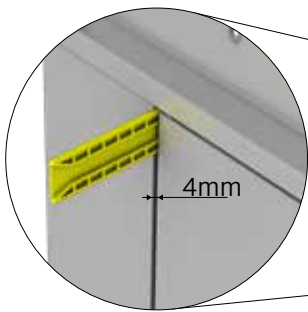
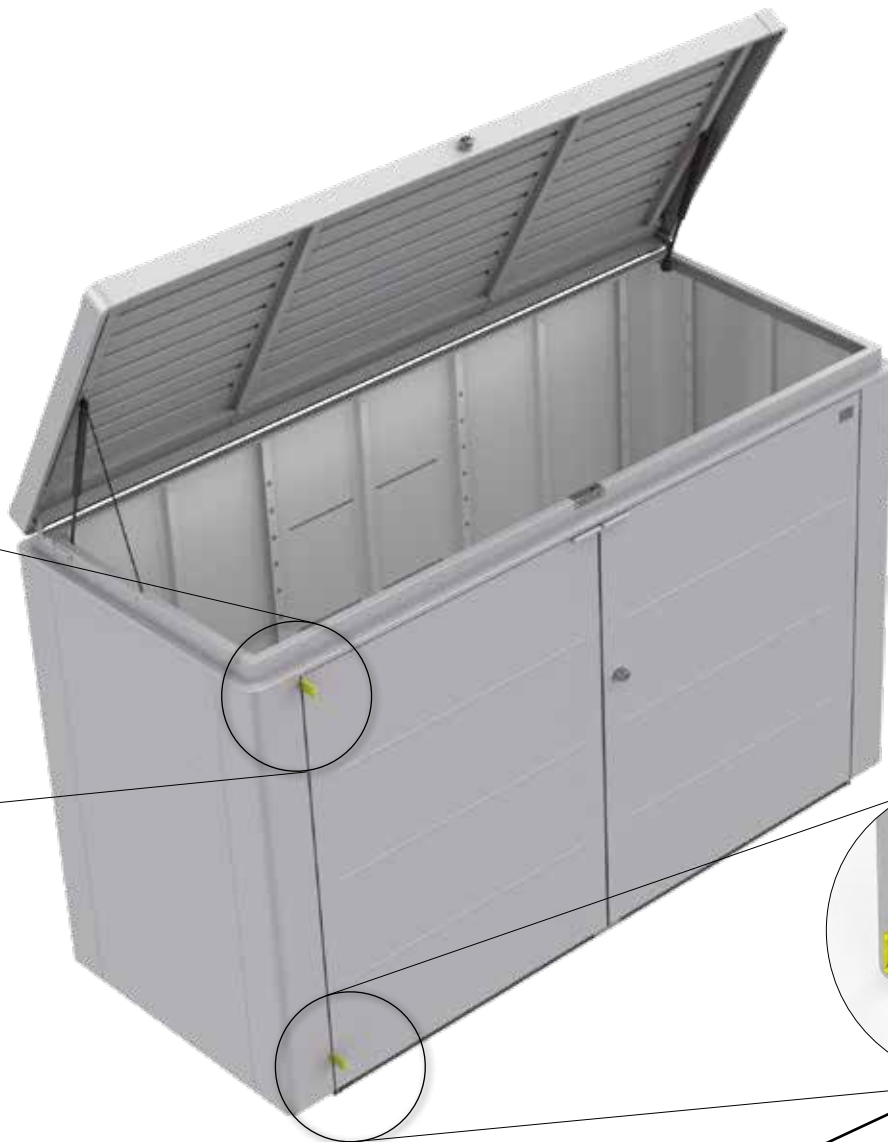
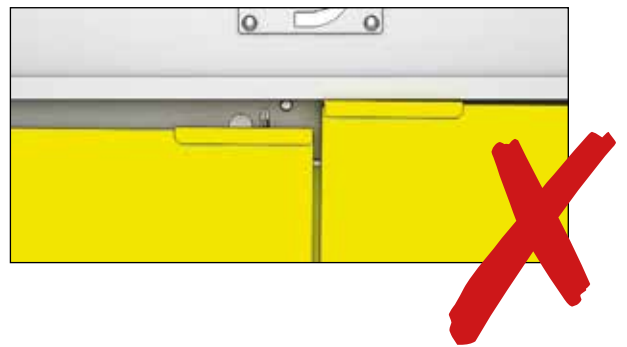
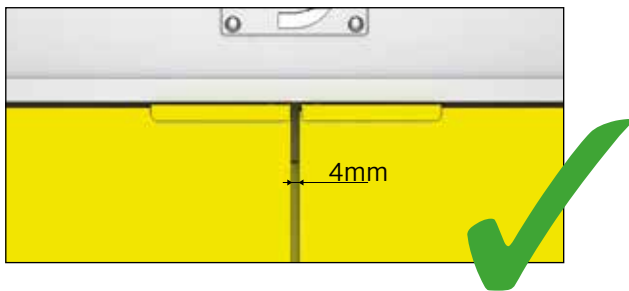
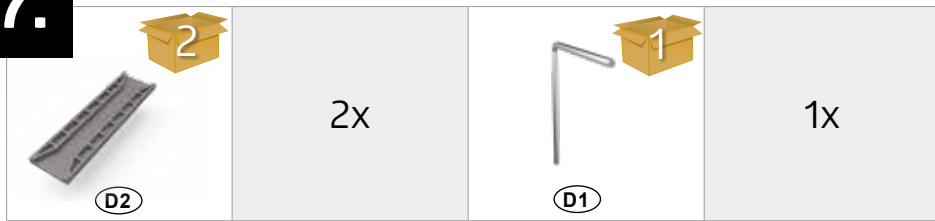

27.



28.

 D2	6x	 D2	6x
---	----	---	----

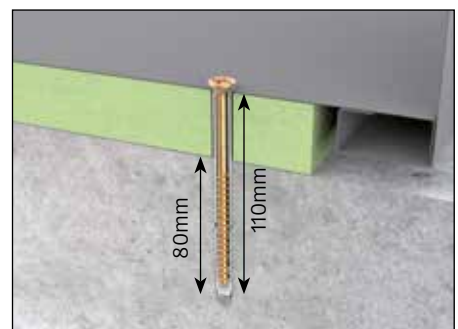
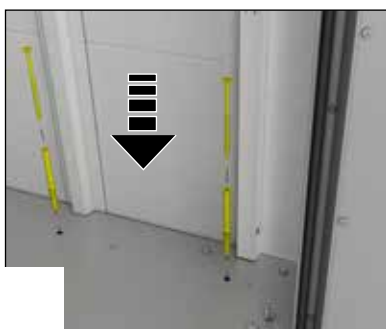
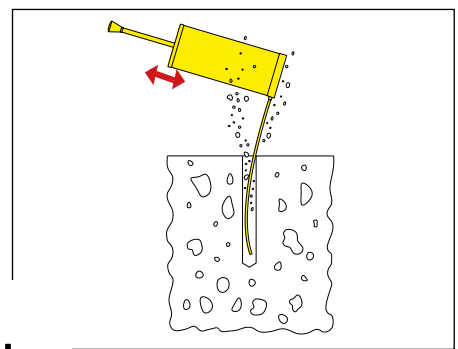
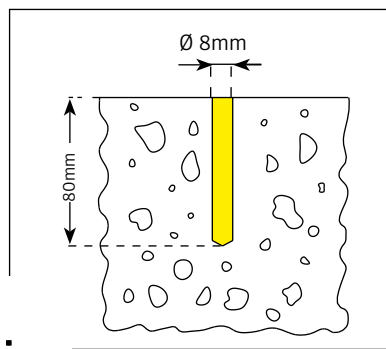
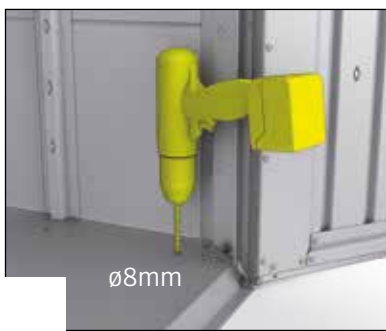
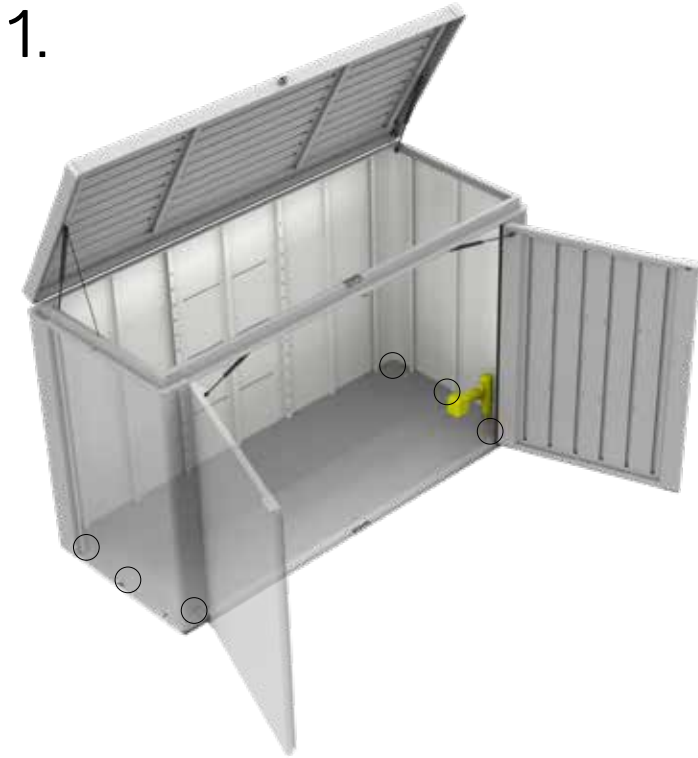

29.

 D2	3x	 D2	3x	 D2	3x
---	----	---	----	---	----

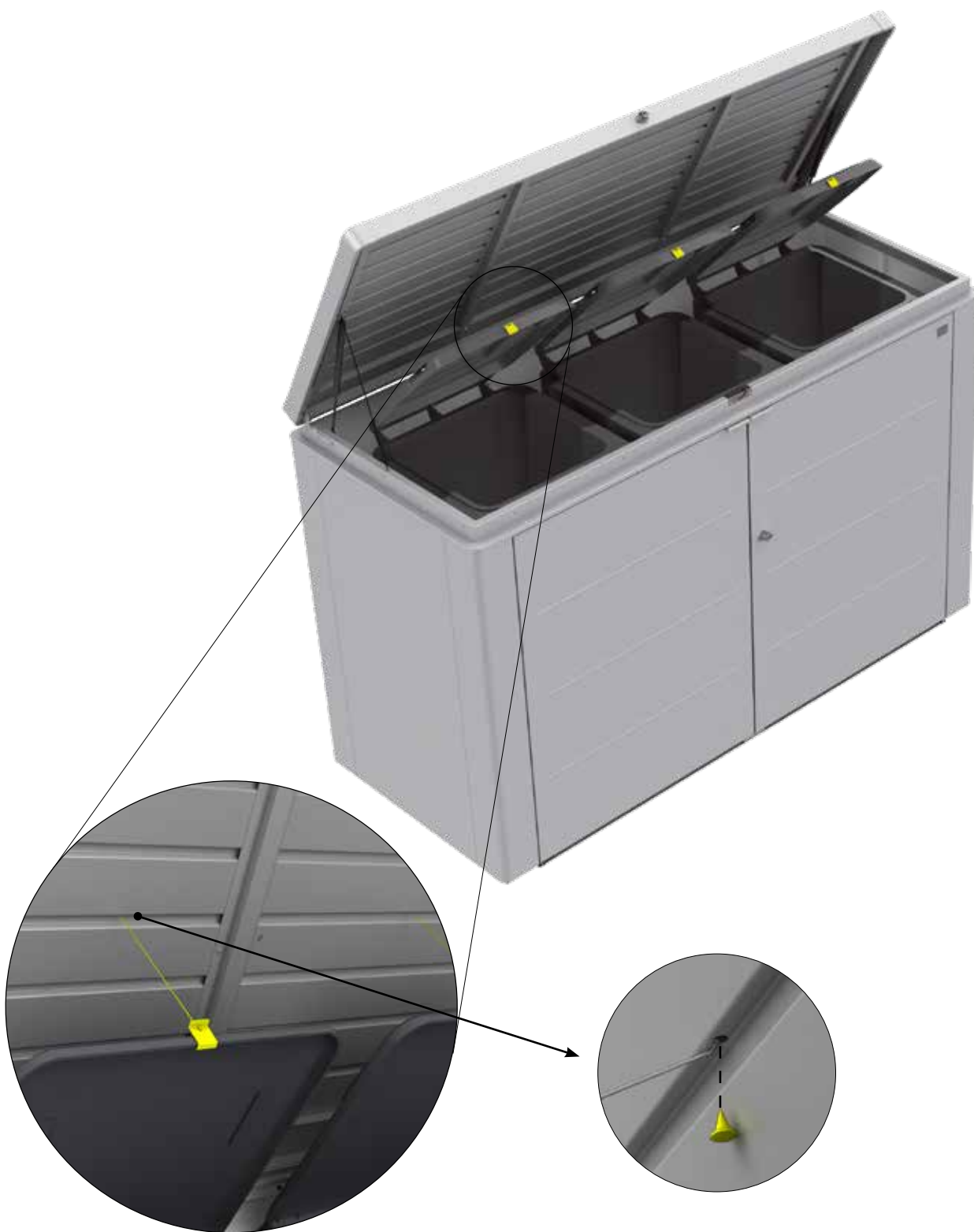

30.





Werkzeughalter



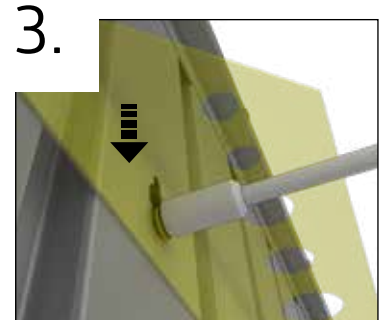
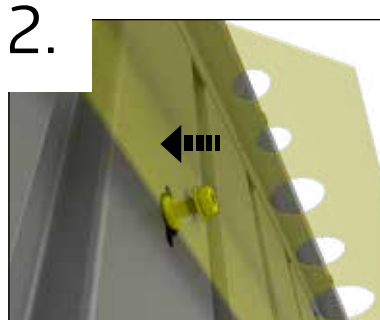
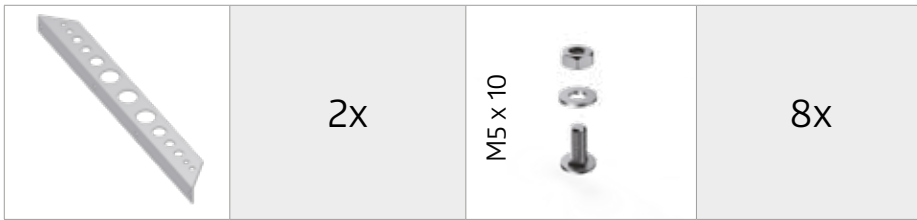

tool holder · Supports de petits outils · Werktuighouder · portaherramientas · portautensili · redskapsholder · redskapshållare · Verktøyholder · Uchwyt narzędziowy · Držák nástrojov · držalo za orodje · Držák na nářadí · Szerszám tartó · držák alata · Suport unelte



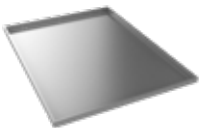

Zwischenboden Opt. 1

intermediate shelf · Sol intermédiaire · tussenbodem · estante intermedio · ripiano intermedio · Mellemhylde · mellanhylla · Mellomhylle · Półka pośrednia · Medzipodlaha · vmesna polica · Mezipodlážka · Közbenő polc · Umjesna ploča · Raft intermediar

	2x		1x		1x
M4 x 10 	6x	4,8 x 9,5 	9x		

1.

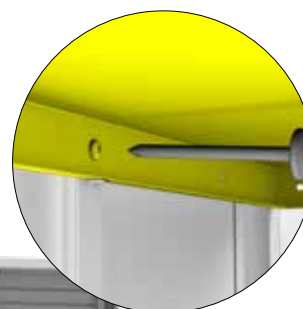
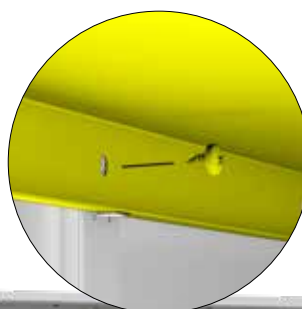
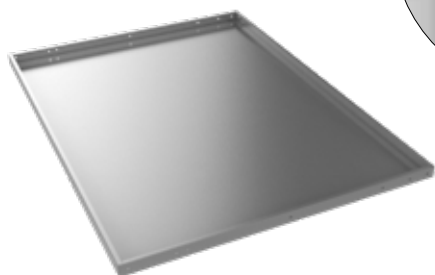

2.



3.

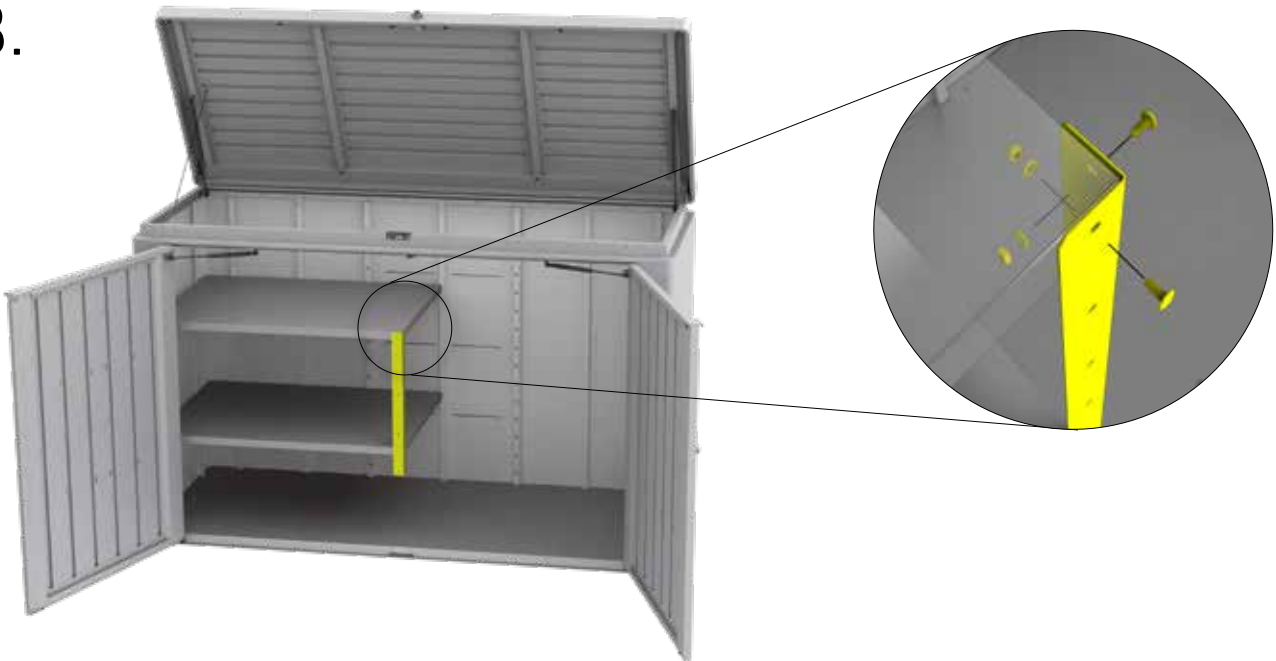

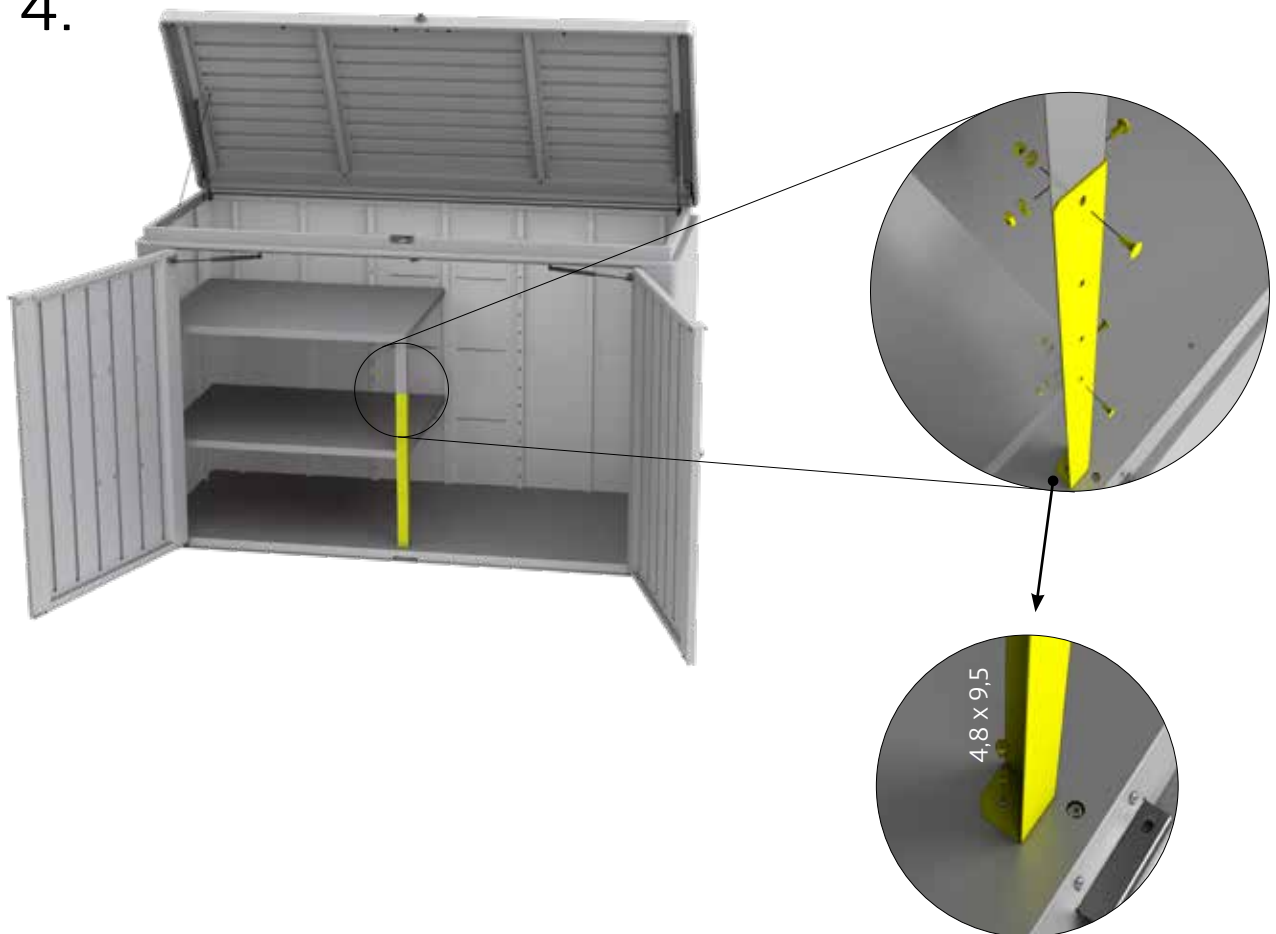

4.



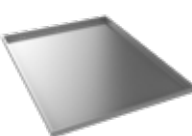

Zwischenboden Opt. 2

intermediate shelf · Sol intermèdiaire · tussenbodem · estante intermedio · ripiano intermedio · Mellemhylde · mellanhylla · Mellomhylle · Półka pośrednia · Medzipodlaha · vmesna polica · Mezipodlážka · Közbenő polc · Umjesna ploča · Raft intermediar

	2x		1x		1x
M4 x 10 	8x	4,8 x 9,5 	9x		

1.

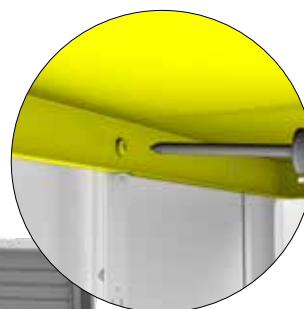
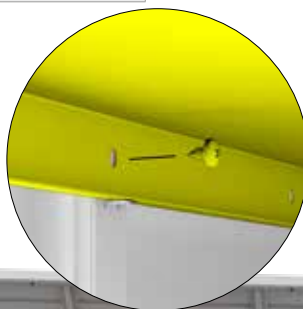

2.



3.

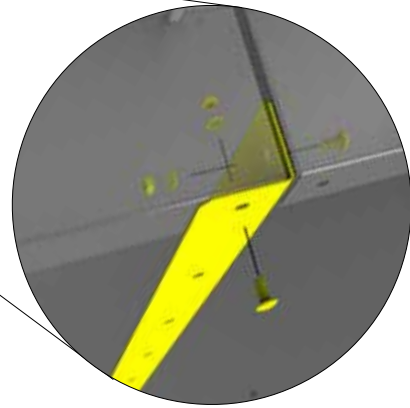
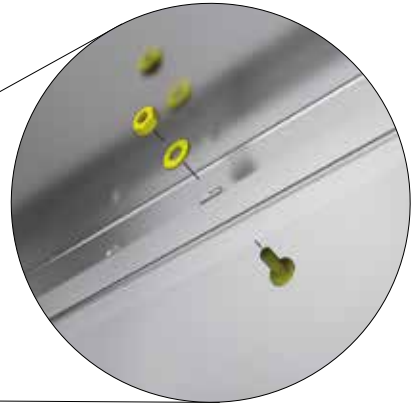
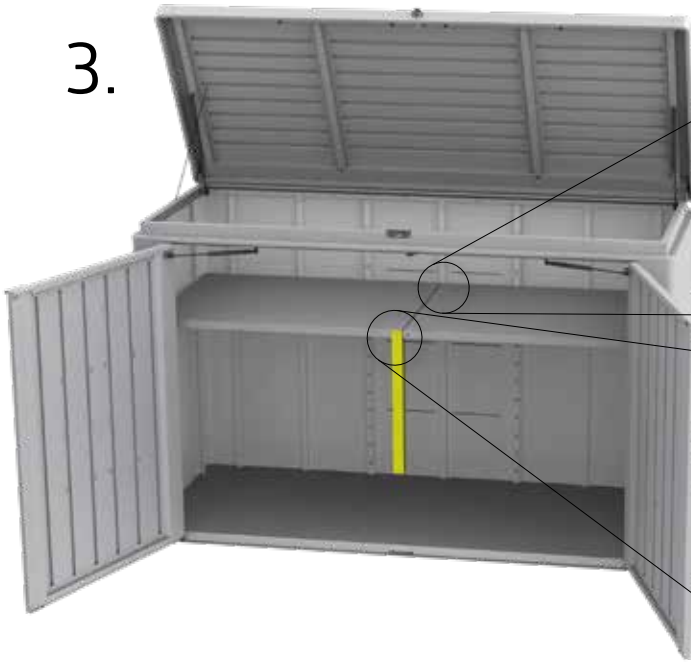

4.

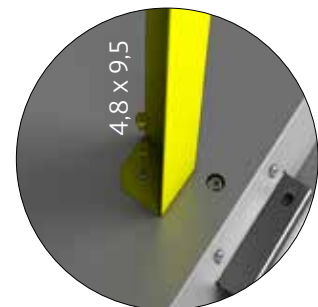
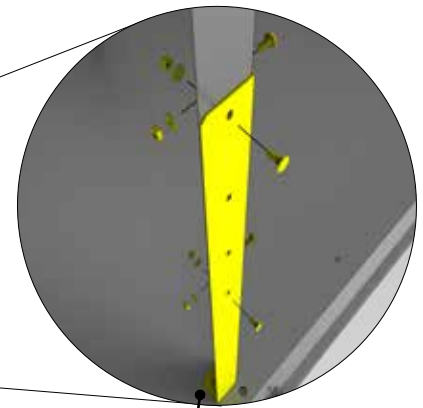
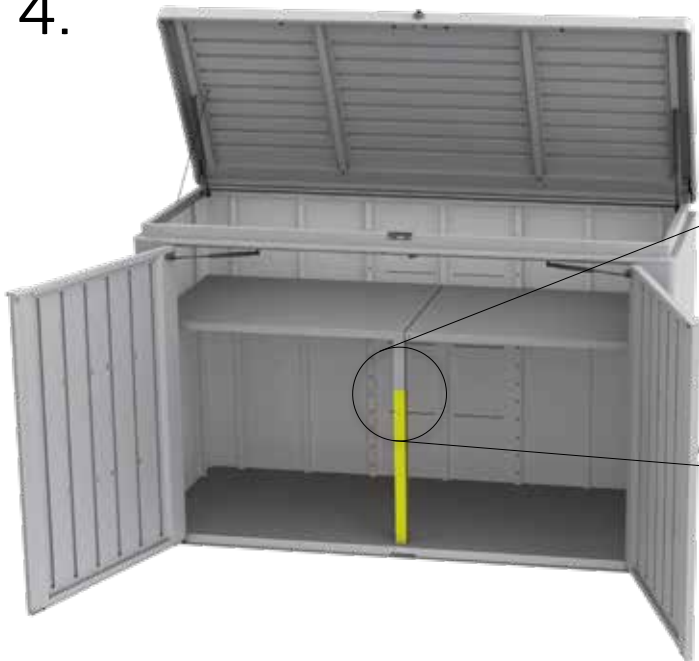



BikeHolder

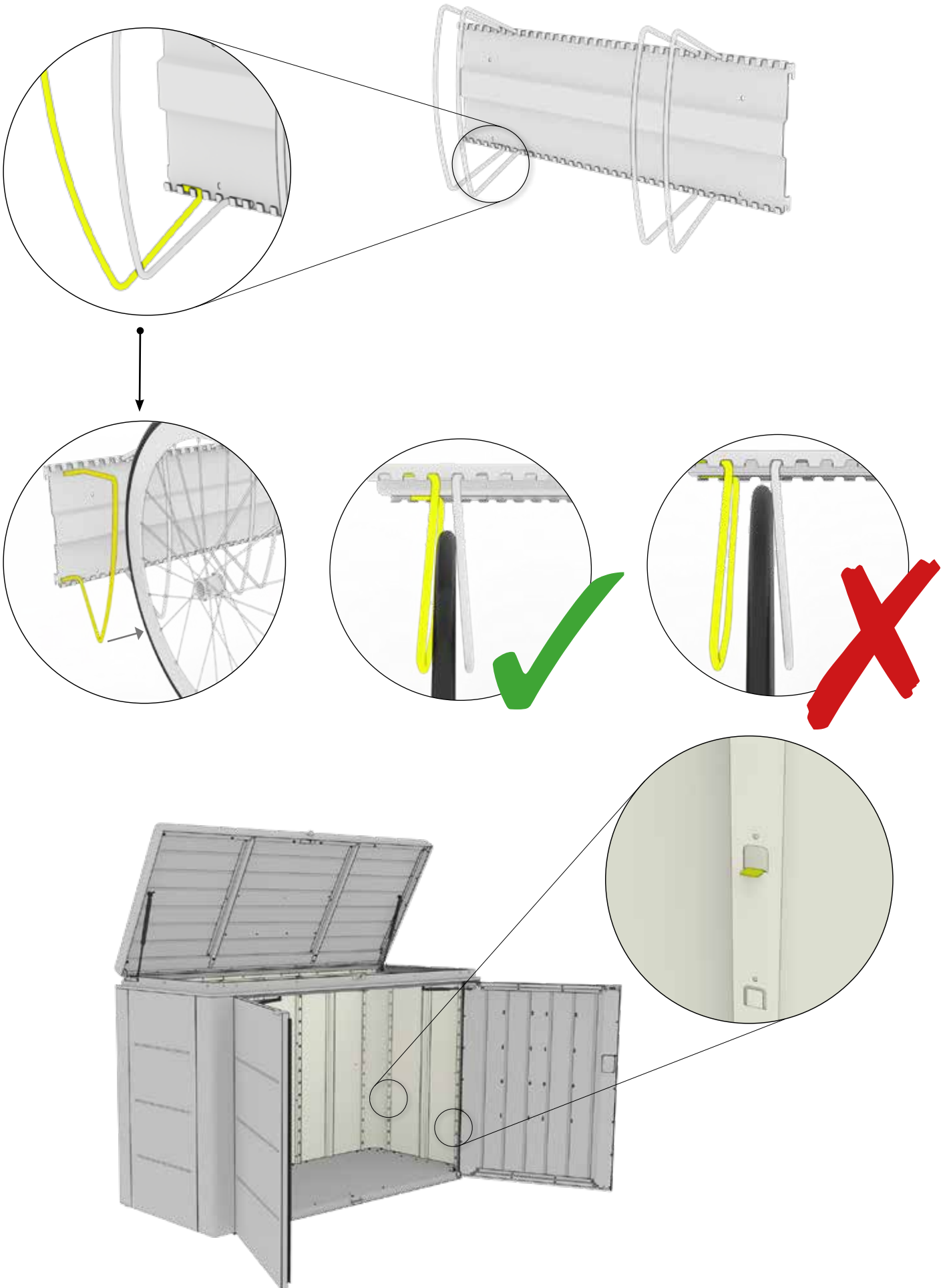

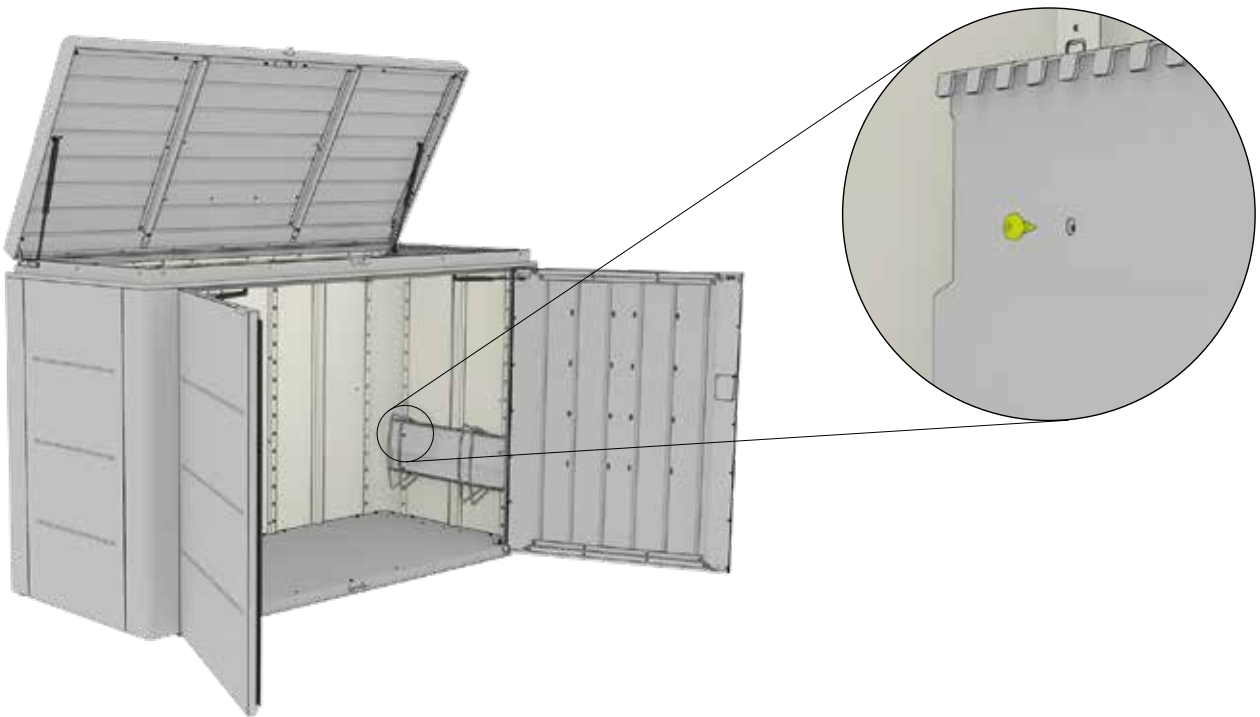
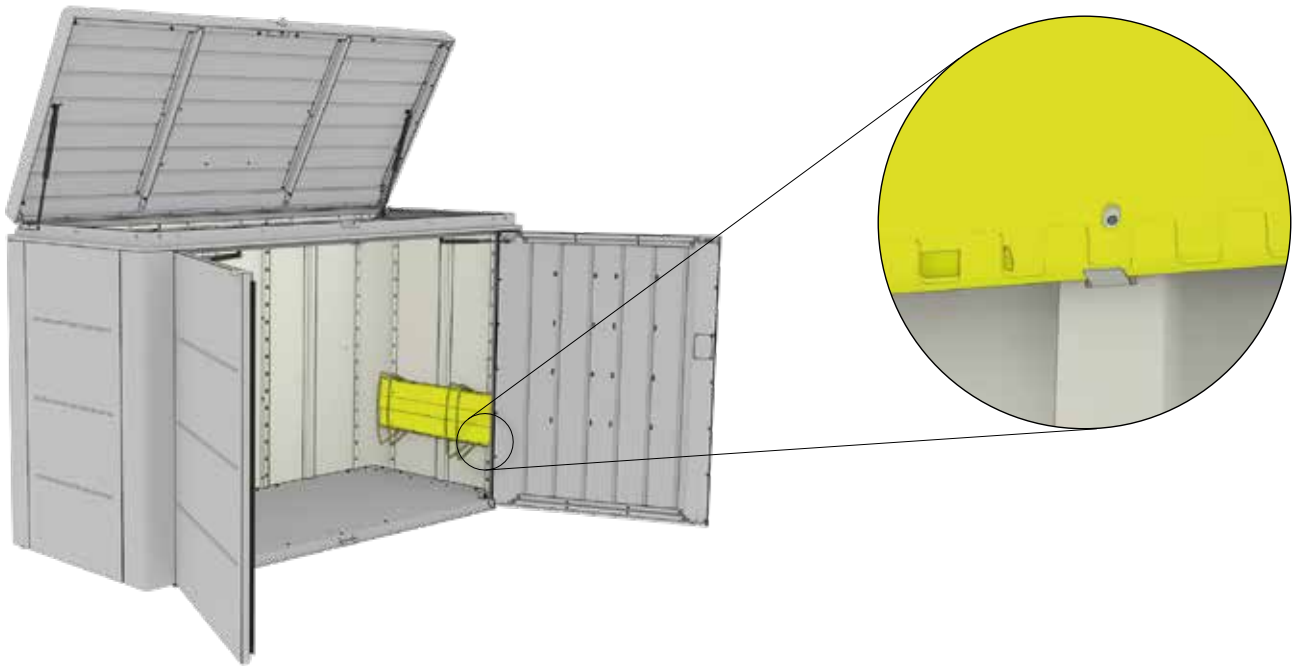



GERÄTEHÄUSER – Setzen Sie auf Qualität & Langlebigkeit
GARDEN SHEDS – rely on quality & longevity



GARTENBOXEN – Outdoorboxen für Garten, Terrasse & Co.
OUTDOOR BOXES – outdoor boxes for garden, patio & etc.



FAHRRAD-GARAGEN – Fahrräder, Roller & Co. sicher verstaut
BICYCLE STORAGE – bicycles, scooters & etc. safely stowed



MÜLLTONNEN-BOXEN – Stylish, praktisch & wartungsfrei
DUSTBIN STORAGE – stylish, practical & maintenance free



GARTEN-HELPER – Gartendesign in Bestform
GARDENING HELPERS – garden design at its best



Biohort steht für
„LEBEN IM GARTEN“

Biohort stands for
„LIFE IN THE GARDEN“

follow us:

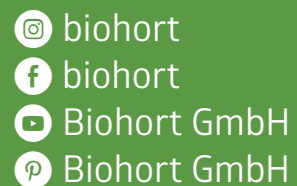

Biohort GmbH
 Pürnstein 43, 4120 Neufelden, Österreich
 +43 7282 / 7788 0
 E-Mail: office@biohort.at
 www.biohort.com



Adresses sur quefairedemesdechets.fr